



UNIVERSITY OF ALLAHABAD

XIV Annual Report

2018-19

(1st April 2018 to 31st March 2019)

Allahabad-211002

U.P. India

www.allduniv.ac.in

CONTENTS

S.N.		Pg No.
	Hon'ble Visitor of the University	
	From the Vice-Chancellor's Desk	
	Editorial Committee	
1.	University of Allahabad: At a Glance	1
2.	Mission-Vision and Milestones of University	8
3.	Highlights of Academic and Administrative Initiatives	10
4.	Finance : At a Glance	19
5.	Academic Programmes and Admissions	24
6.	Faculty Positions at a Glance	32
7.	Faculties, Departments, Centres and Institutes	
	Faculty of Arts	
	• Department of Ancient History, Culture and Archaeology	34
	• Department of Anthropology	37
	• Department of Arabic and Persian	40
	• Department of Education	43
	• Department of English and Modern European Languages	49
	• Department of Geography	54
	• Department of Hindi and Modern Indian Languages	58
	• Department of Journalism and Mass Communication	64
	• Department of Medieval and Modern History	65
	• Department of Music and performing Arts	67
	• Department of Philosophy	70
	• Department of Physical Education	74
	• Department of Political Science	76
	• Department of Psychology	81
	• Department of Sanskrit, Pali, Prakrit and Oriental Languages	85
	• Department of Sociology	87
	• Department of Urdu	92
	• Department of Visual Arts	94
	Faculty of Commerce	
	• Department of Commerce and Business Administration	99
	• Department of Economics	104
	Faculty of Law	
	• Department of Law	108
	Faculty of Science	
	• Department of Bio-Chemistry	112
	• Department of Botany	119
	• Department of Chemistry	122
	• Department of Defence and Strategic Studies	126
	• Department of Earth and Planetary Sciences	129
	• Department of Electronics and Communication	134
	• Department of Home Science	139
	• Department of Mathematics	145
	• Department of Physics	150
	• Department of Statistics	154
	• Department of Zoology	157

	Institute of Interdisciplinary Studies	
	(a) Centre of Bio-technology	162
	(b) Centre of Bio-informatics	168
	(c) Centre for Film & Theatre	171
	(d) Centre for Women's Studies	172
	(e) Centre of Development Studies	176
	(f) K. Banerjee Centre of Atmospheric & Ocean Sciences	180
	(g) Centre of Materials Science	186
	(h) Nano Technology Application Centre	193
	(i) Centre of Rural Technology & Development	199
	• Centre of Behavioural and Cognitive Sciences	205
	Institute of Professional Studies	
	(a) Centre of Food Technology	210
	(b) Centre of Computer Education	215
	(c) Centre of Media Studies	219
	(d) Centre of Fashion Design & Technology	226
	• National Centre of Experimental Mineralogy & Petrology	229
	• Design Innovation Centre	231
	• Govind Ballabh Pant Social Science Institute	234
	• Rajiv Gandhi Chair in Contemporary Studies	241
8.	Students Amenities and Activities	
	• Students' Welfare Activities	242
	• Jawaharlal Nehru Centre of Disabilities	244
	• Sports Board	245
	• National Service Scheme (NSS)	246
	• National Cadet Corps (NCC)	248
	• International Students Advisor	249
	• Proctors Office	252
	• Central Cultural Committee	253
9.	Central Facilities	
	• Central Library	254
	• Engineering and Works Department	257
10.	Other Activities	
	• University Industry Interface Cell	259
	• University Placement Cell	260
	• UGC Human Resource Development Centre	263
	• Office of the Academic Programmes	266
	• Rajbhasha Cell	267
11.	Research Publications of the Faculty	272
12.	Details of the Research Projects	322
13.	Report of the Constituent Colleges	331
14.	List of Research Scholars Enrolled	357
15.	Doctoral Degree Awarded	379

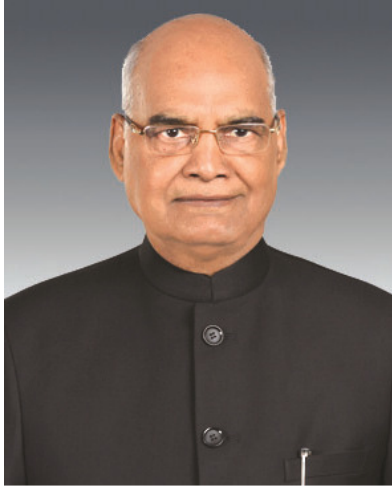

*The Visitor Hon'ble His Excellency
President of India
Sri Ram Nath Kovind*



*The Chief Rector Hon'ble Her Excellency
Governor of Uttar Pradesh
Smt. Anandiben Patel*

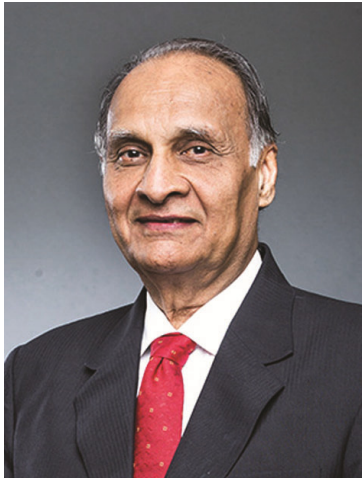

*Hon'ble Chancellor
Prof. Goverdhan Mehta*



*Hon'ble Vice-Chancellor
Prof. Rattan Lal Hangloo*

Hon'ble Visitor of the University

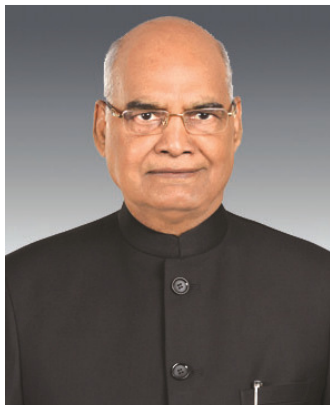

The Visitor Hon'ble His Excellency
President of India
Sri Ram Nath Kovind

A lawyer, veteran political representative and long-time advocate of egalitarianism and integrity in Indian public life and society, Shri Ram Nath Kovind was born on October 1, 1945, in Paraunkh, near Kanpur, Uttar Pradesh. His parents were Shri Maiku Lal and Smt Kalawati.

Before assuming charge of the office of the 14th President of India on July 25, 2017, Shri Kovind served as the 36th Governor of the state of Bihar from August 16, 2015, to June 20, 2017.

Educational and Professional Background

Shri Kovind completed his school education in Kanpur and obtained the degrees of B.Com and L.L.B. from Kanpur University. In 1971, he enrolled as an Advocate with the Bar Council of Delhi.

Shri Kovind was Union Government Advocate in the Delhi High Court from 1977 to 1979 and Union Government Standing Counsel in the Supreme Court from 1980 to 1993. He became Advocate-on-Record of the Supreme Court of India in 1978. He practised at the Delhi High Court and Supreme Court for 16 years till 1993.

Parliamentary and Public Life

Shri Kovind was elected as a member of the Rajya Sabha from Uttar Pradesh in April 1994. He served for two consecutive terms of six years each till March 2006. Shri Kovind served on various Parliamentary Committees like Parliamentary Committee on Welfare of Scheduled Castes/Tribes; Parliamentary Committee on Home Affairs; Parliamentary Committee on Petroleum and Natural Gas; Parliamentary Committee on Social Justice and Empowerment; and Parliamentary Committee on Law and Justice. He was Chairman of the Rajya Sabha House Committee.

Shri Kovind also served as Member of the Board of Management of the Dr B.R Ambedkar University, Lucknow, and Member of the Board of Governors of the Indian Institute of Management, Kolkata. He was part of the Indian delegation at the United Nations and addressed the United Nations General Assembly in October 2002.

Positions Held

2015-17: Governor of Bihar

1994-2006: Member of the Rajya Sabha, representing the state of Uttar Pradesh

1971-75 and 1981: General Secretary, Akhil Bharatiya Koli Samaj

1977-79: Union Government Advocate at the Delhi High Court

1982-84: Union Government Junior Counsel in the Supreme Court

Personal Details

Shri Kovind married Smt Savita Kovind on May 30, 1974. They have a son, Shri Prashant Kumar, and a daughter, Miss Swati. An avid reader, the President has keen interest in reading books on politics and social change, law and history, and religion.

During his long public career, Shri Kovind has travelled widely across the country. He has also visited Thailand, Nepal, Pakistan, Singapore, Germany, Switzerland, France, the United Kingdom and the United States in his capacity as a Member of Parliament.

From the Vice-Chancellor's Desk

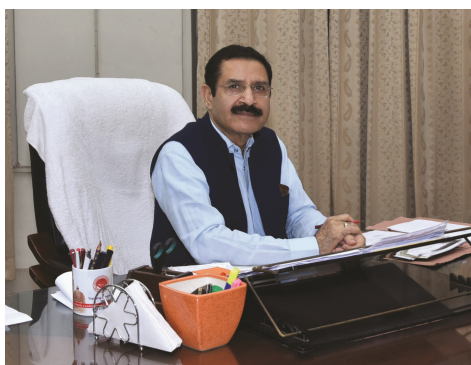

Hon'ble Vice-Chancellor
Prof. Rattan Lal Hangloo

Greetings from the University of Allahabad!

It is a matter of great pleasure to present to you the Annual Report of the University of Allahabad for the Academic Year 2018-2019. The report has been prepared to provide information related to profile of the University and its various academic units, courses of study, enrollment of students, activities and achievement of the faculty members and students of the University as well as institutions admitted to its privileges.

I take this opportunity to inform you that the year under report witnessed significant progress in academic, administrative, financial, and infrastructural activities. In the backdrop of steady reforms brought in during the last 3 years, the University has started consolidating its gains, which is visible through year round academic activities of high quality in the campus. The University is marching ahead on the path of success and has started doing well on all fronts. The University fully understands its responsibility of capacity building for national development. The University is making rapid strides to meet the challenges of higher education in modern times. The highest priority has been given to raise the standard of teaching, learning, research and innovation in the University.

The new faculty appointments were made in the Department of Hindi, Computer Science, Home Science, Globalization Studies, Women Studies, and Science & Society during this year. The regular appointments on the posts Registrar, Finance Officer, Law Officer, and Information Scientist were also made. The mandatory NAAC accreditation was carried out in this year after a gap of 15 years. The University has established major research facility of MRI in February 2019 with the support from the DST, Govt. of India. Four new departments have got support under the DST-FIST scheme. The University has ensured optimum utilization of the ICT tools in administration and teaching and is committed towards making the University totally web enabled.

We have organized several distinguished lectures by eminent academicians and social scientists this year also. The University has also witnessed organization of national and international seminars throughout the year. The faculty members and students brought laurels to the University. Several faculty members have been honoured with prestigious national and international awards in India and abroad. The number of publications by faculty members has significantly increased. The extra-mural Govt. of India sponsored research project

funding has increased during this academic year. The students got very good selections in civil and provincial services examinations, higher educational institutions, judicial services as well as in private organizations.

The infrastructural development was given a major boost. The construction work in the Vijayanagaram Hall and Tilak Bhawan was completed during this academic year. The major renovation and upkeep work in several departments was also carried out besides repair and maintenance of Hostels. I am very happy to inform you all that the construction work in the three new Hostels (one each for Girls, Boys and International Students) has started during this year.

These efforts have helped the University to carve a niche for itself among the institutions of higher learning in India and abroad. For the full realization of University's vision and mission, all stakeholders must champion its cause without any prejudice or parochial considerations. I am confident that collectively we can overcome all challenges and will continue moving forward on the path of success with the same momentum in the coming years also.

I would like to express my deep sense of gratitude to the Hon'ble Visitor and Chief Rector of the University for their constant support and encouragement. Thanks are also due to the Members of the Court, Executive Council, Academic Council, and Finance Committee for their guidance and support. I take this opportunity to place on record my sincere appreciation and acknowledgement for the untiring efforts of the faculty members, officials, staff, students and other stakeholders of the University towards achieving the desired goals. I also thank the members of Annual Report Committee Prof. Suneet Dwivedi, Prof. Neelam Yadav, Dr. Shailendra Rai and Prof. A. R. Siddiqui for bringing out this publication in a timely manner.

I hope that the readers will find the Annual Report informative and useful.

Thank you!

Prof. Rattan Lal Hangloo
Vice Chancellor

PREFACE

The Annual Report committee presents University's XIV Annual report for the year 2018-19. We have summarized the salient activities and achievements of the university in the report. The report consists of academic, administrative and research related information and data of all sections of the University. The report also includes information about infrastructural development and new initiatives taken up by the university in this year.

University has adopted strategies of renovating academic system to make it more effective and face the emerging challenges. Rich contribution of faculty members in form of papers, books, research projects earned from various national and international agencies, awards and honours won by them are also presented in report and reflects rich academic environment of the university. The Annual Report also reflects various facets of academic and co-curricular activities conducted by the University and its colleges.

We wish to place on record our gratitude to the Hon'ble Vice-Chancellor Prof R L Hangloo for his keen interest, valuable guidance and encouragement in completing this report. Editorial Committee members extend their thanks to Deans, HoDs, Directors, Coordinators, Faculty, Officers, and In Charge of different Academic/Administrative Units of the University for providing relevant information and support in compiling the Report. The Committee is appreciative of the work of non-teaching staff, especially Shri Mool Chandra Kushwaha and Mr. Sushil Kumar who provided their unstinted support in compilation of report in present form. We also acknowledge the efforts of Mr. Hariom Kumar in translating the Hindi version of this report. The discrepancy, if any, is sincerely regretted.

Suneet Dwivedi

Neelam Yadav

A. R. Siddiqui

Shailendra Rai

UNIVERSITY AT A GLANCE

University of Allahabad: At a Glance 2018-19 (as on 31/03/2019)

Year of establishment	1887, Declared 'An Institute of National Importance' vide University of Allahabad Act, 2005 (No. 26 dated 23 June 2005)																		
Jurisdiction	The power conferred on the University shall be exercisable in respect of the area within a radius of sixteen kilometers from the Convocation Hall of the University, without prejudice to the territorial jurisdiction over the said area that may be assigned to any other University.																		
Whether Unitary or affiliating	Affiliating																		
Campus area	<table border="0"> <tr> <td>Senate Campus Area</td> <td>= 78.216 Acres</td> </tr> <tr> <td>M.C.C. Campus Area</td> <td>= 67.08 Acres</td> </tr> <tr> <td>Chatham Lines Campus Area</td> <td>= 49.46 Acres</td> </tr> <tr> <td>Engineering College Area</td> <td>= 13.402 Acres</td> </tr> <tr> <td>Beli Farm Area</td> <td>= 12.656 Acres</td> </tr> <tr> <td>Shila Dhar Institute of Soil Science Area</td> <td>= 3.494+0.788 = 4.282 Acres</td> </tr> <tr> <td>Pura Gadaria Area</td> <td>= 3.61 Acres</td> </tr> <tr> <td>F.C.I. Area</td> <td>= 3.555 Acres</td> </tr> <tr> <td>Total</td> <td>= 232.261 Acres</td> </tr> </table>	Senate Campus Area	= 78.216 Acres	M.C.C. Campus Area	= 67.08 Acres	Chatham Lines Campus Area	= 49.46 Acres	Engineering College Area	= 13.402 Acres	Beli Farm Area	= 12.656 Acres	Shila Dhar Institute of Soil Science Area	= 3.494+0.788 = 4.282 Acres	Pura Gadaria Area	= 3.61 Acres	F.C.I. Area	= 3.555 Acres	Total	= 232.261 Acres
Senate Campus Area	= 78.216 Acres																		
M.C.C. Campus Area	= 67.08 Acres																		
Chatham Lines Campus Area	= 49.46 Acres																		
Engineering College Area	= 13.402 Acres																		
Beli Farm Area	= 12.656 Acres																		
Shila Dhar Institute of Soil Science Area	= 3.494+0.788 = 4.282 Acres																		
Pura Gadaria Area	= 3.61 Acres																		
F.C.I. Area	= 3.555 Acres																		
Total	= 232.261 Acres																		
No. of affiliating Colleges, with State/UT wise break-up	<p>Total 11 Constituent Colleges (All located in Allahabad, UP)</p> <ul style="list-style-type: none"> • Allahabad Degree College, Allahabad • Arya Kanya Degree College, Allahabad • Chaudhary Mahadeo Prasad Degree College, Allahabad • Ewing Christian College, Allahabad • Iswar Saran Degree College, Allahabad • Hamidia Girls' Degree College, Allahabad • Jagat Taran Girls' Degree College, Allahabad • K.P. Training College, Allahabad • Rajarshi Tandon Girls' Degree College, Allahabad • Sanwal Dass Sadan Lal Khanna Girls' Degree College, Allahabad • Shyama Prasad Mukherji Govt. Degree College, Allahabad 																		
Number of Faculties / Schools	04 + 01																		
Number of Departments / Centres/ Chairs	<table border="0"> <tr> <td>Departments:</td> <td>32</td> </tr> <tr> <td>University College:</td> <td>NIL</td> </tr> <tr> <td>University Institutes:</td> <td>03</td> </tr> <tr> <td>(with 16 Centres, 12 in IIDS & 04 in IPS)</td> <td></td> </tr> <tr> <td>Chairs:</td> <td>06</td> </tr> <tr> <td>Temporary (Self Financing) University Institute:</td> <td>01</td> </tr> <tr> <td>Independent Centre:</td> <td>01</td> </tr> <tr> <td>Constituent Institute:</td> <td>01</td> </tr> <tr> <td>Constituent Colleges:</td> <td>11</td> </tr> </table>	Departments:	32	University College:	NIL	University Institutes:	03	(with 16 Centres, 12 in IIDS & 04 in IPS)		Chairs:	06	Temporary (Self Financing) University Institute:	01	Independent Centre:	01	Constituent Institute:	01	Constituent Colleges:	11
Departments:	32																		
University College:	NIL																		
University Institutes:	03																		
(with 16 Centres, 12 in IIDS & 04 in IPS)																			
Chairs:	06																		
Temporary (Self Financing) University Institute:	01																		
Independent Centre:	01																		
Constituent Institute:	01																		
Constituent Colleges:	11																		
Names of Faculties/ Institutes and institutions maintained by the University	<p>Faculties:</p> <ol style="list-style-type: none"> 1. Arts 2. Science 3. Law 4. Commerce 																		

<p>No. of Departments</p>	<p>Faculty of Arts:</p> <ol style="list-style-type: none"> 1. Ancient History, Culture and Archaeology 2. Anthropology 3. Arabic and Persian 4. Education 5. English and Modern European Languages 6. Geography 7. Hindi and Modern Indian Languages 8. Journalism and Mass Communication 9. Medieval and Modern History 10. Music and performing Arts 11. Philosophy 12. Physical Education 13. Political Science 14. Psychology 15. Sanskrit, Pali, Prakrit and Oriental Languages 16. Sociology 17. Urdu and 18. Visual Arts <p>Faculty of Commerce:</p> <ol style="list-style-type: none"> 1. Commerce and Business Administration, and 2. Economics <p>Faculty of Law:</p> <ol style="list-style-type: none"> 1. Law <p>Faculty of Science:</p> <ol style="list-style-type: none"> 1. Bio-Chemistry 2. Botany 3. Chemistry 4. Defence and Strategic Studies 5. Earth and Planetary Sciences 6. Electronics and Communication 7. Home Science 8. Mathematics 9. Physics 10. Statistics 11. Zoology
<p>Institutes of the University</p>	<p>1. Institutes of Interdisciplinary Studies</p> <ol style="list-style-type: none"> (a) Centre of Bio-technology (b) Centre of Bio-informatics (c) Centre of Globalization and Development Studies (d) K. Banerjee Centre of Atmospheric & Ocean Sciences (e) Centre of Materials Science (f) Nano Technology Application Centre (g) Centre for Film & Theatre (h) Centre for Women's Studies (i) Centre for Gandhian Thoughts & Peace Studies (j) M.N. Saha Centre of Space Studies (k) Centre of Environmental Sciences (l) Centre of Rural Technology & Development
	<p>2. Institute of Professional Studies</p> <ol style="list-style-type: none"> a) Centre of Food Technology b) Centre of Computer Education c) Centre of Media Studies d) Centre of Fashion Design & Technology <p>3. National Centre for Experimental Mineralogy & Petrology</p>

Constituent Institute of the University	4.Govind Ballabh Pant Social Science Institute
Name of Chairs	(i) Nirala Chair in Hindi (ii) Planning Commission of India Chair in Economics (iii) Munshi Premchand Chair in Urdu (iv) Ganganath Jha Chair in Sanskrit (v) Rajiv Gandhi Chair in Contemporary Studies (vi) Meghnad Saha Chair in Physics
Independent Centre	Centre for Behavioural & Cognitive Science

Number of Departments / Centres getting support under SAP	05
Number of Departments / Centres getting support under FIST	07
Number of Departments / Centres getting support from other organization like DST, DBT, ICSSR, ICMR, etc.	21
Number of Departments / Centres having collaboration / exchange programmes with other national and international institutions	12
Total Students (Regular Courses including Self-financing courses) (Excluding distance education programmes)	22150
Out of total students:	
SC/ST	4992
OBC	10004
Differently Abled students	129
Total number of Transgender students	0
Total Female Students (Regular Courses) (Out of total students)	7217
Percentage of Female Students	32.58
Teaching Staff (Sanctioned)	863
Teaching filled positions (Existing) on regular basis	312
Vacant Teaching Positions	551
Non-Teaching Staff (sanctioned)	1389
Non-teaching Staff (Existing)	874
Vacant Non-Teaching Positions	515
Teacher : Students Ratio (On Sanctioned Strength)	1 : 25.66
Teacher : Students Ratio (On Existing Strength)	1 : 70.99
Teaching : Non-Teaching Ratio (Sanctioned Teaching Positions: Sanctioned Non-Teaching Positions)	1 : 1.60
Teaching : Non-Teaching Ratio (Existing Teaching Positions: Existing Non-Teaching Positions)	1 : 2.80
Number of Books in the Library (Central Library)	750983
Number of Journals subscribed (including e-journals)	21729
Number of Degrees awarded (during the academic year 2018-19)	
Ph.D.	225
Publications of the University	693
Publications indexed in Scopus (2018-2019)	
Scopus citations	478
Scopus (h-index)	09
Publications indexed in Web of Science	
Web of Science citations	299
Web of Science (h-index)	07

The Executive Council

MEMBERSHIP CONSTITUTION OF THE EXECUTIVE COUNCIL

Updated as on 31-03-2019

THE EXECUTIVE COUNCIL SHALL CONSIST OF THE FOLLOWING MEMBERS NAMELY :		
(a)	the Vice-Chancellor; Prof. Rattan Lal Hangloo , Vice-Chancellor, University of Allahabad, Allahabad email: vcoffice@allduniv.ac.in	
(b)	the Pro-Vice-Chancellor, if any; -Vacant-	
(c)	THREE DEANS OF FACULTIES, TO BE SELECTED BY ROTATION IN THE ORDER IN WHICH THE FACULTIES ARE ENUMERATED IN CLAUSE (1) TO STATUTE (14); (FOR A PERIOD OF TWO YEARS).	
	1. Prof. K.S. Misra, Dean, Faculty of Arts, A.U., Allahabad Department of Education, A.U., Allahabad.	w.e.f. 13.07.2018 to 12.07.2020
	2. Prof. A.K. Mukherjee, Dean, Faculty of Commerce, UoA Department of Commerce, A.U., Allahabad.	w.e.f. 23.03.2019 to 12.07.2020
	3. Prof. Jagdamba Singh, Dean, Faculty of Science Department of Chemistry, A.U., Allahabad	(w.e.f. 04.07.2018 to 08.02.2019)
(d)	ONE DIRECTOR OF A CONSTITUENT INSTITUTE, TO BE SELECTED BY ROTATION IN THE ORDER OF LENGTH OF SUBSTANTIVE SERVICE AS SUCH DIRECTOR;	
	Prof. B.N. Tiwari, (single Constituent Institute) Director, G.B. Pant Social Science Institute, Jhansi, Allahabad	
(e)	ONE PRINCIPAL OF A CONSTITUENT COLLEGE, TO BE SELECTED BY ROTATION IN THE ORDER OF LENGTH OF SUBSTANTIVE SERVICE AS SUCH PRINCIPAL;	
	Dr. Anand Shankar Singh , Principal, Iswar Saran Degree College, Allahabad	w.e.f. 14.07.2018 to 13.07.2020
(f)	TWO PROFESSORS, TWO READERS AND TWO LECTURERS FROM AMONG THE UNIVERSITY APPOINTED TEACHERS, TO BE SELECTED BY ROTATION IN THE ORDER OF SENIORITY;	
	<u>PROFESSORS</u>	
	1. Prof. P.K. Sahoo, Deptt. of Education, UoA	w.e.f. 05-03-2019 to 04-03-2021
	2. Prof. L.R. Sharma, Deptt. of English, UoA	w.e.f. 05-03-2019 to 04-03-2021
	<u>READERS</u>	
	1. Dr. Pankaj Kumar , Department of Political Science, A.U., Allahabad	w.e.f. 10-10-2017 to 09-10-2019 / till further orders
	2. Shri P.N. Gupta , Department of Electronics & Communication, A.U., Allahabad	w.e.f. 02-07-2018 to 01-07-2020
	<u>LECTURERS</u>	
	1. Sri Sunil Umarao Department of Journalism & Mass Comm., UoA	w.e.f. 22.02.2019 to 21.02.2021
	2. Dr. Ashwajeet Chaudhary , Deptt. of Geography, A.U.	w.e.f. 08.11.2017 to 07.11.2019
(g)	ONE PERSON FROM AMONG THE UNIVERSITY RECOGNIZED TEACHERS OF UNIVERSITY COLLEGES, TO BE SELECTED BY ROTATION IN THE ORDER OF SENIORITY;	
	MLN Medical College and SRNH dilinked from University of Allahabad hence the nomination from A.U. College may not be required.	
	TWO PERSONS FROM AMONG THE UNIVERSITY RECOGNIZED TEACHERS OF CONSTITUENT INSTITUTES, TO BE SELECTED BY ROTATION IN THE ORDER OF SENIORITY, OF WHOM AT LEAST ONE SHALL BE A LECTURER;	
	1. Prof. Bhaskar Majumder , G.B. Pant Social Science Institute, Jhansi, Allahabad	w.e.f. 25-11-2017 to 24-11-2019
	2. Dr. Archana Singh , Assistant Professor, G.B.P.S.S.I	w.e.f. 02-02-2019 to 01-02-2021
	THREE PERSONS FROM AMONG THE UNIVERSITY RECOGNIZED TEACHERS OF CONSTITUENT COLLEGES, TO BE SELECTED BY ROTATION IN THE ORDER OF SENIORITY, OF WHOM AT LEAST ONE SHALL BE A LECTURER;	
	1. Dr. Amitabh Tiwari , Department of Economics (Reader) Allahabad Degree College, Allahabad	(w.e.f. 03-02-2018 To 02-02-2020)
	2. Dr. Mamta Chaturvedi , (Reader) Department of Ancient History, Allahabad Degree College, Allahabad.	(w.e.f. 13.11.2018 to 12.11.2020)
	3. Dr.(Mrs.) K.L. Pandey , (Lecturer) Dept. of Physics, Ewing Christian College, Allahabad	w.e.f. 01.12.2017 to 30.11.2019
	FOUR PERSONS TO BE NOMINATED BY THE VISITOR;	
	1. Prof. Neeta Sehgal Professor Department of Zoology,	w.e.f. 28.02.2019 to 27.02.2022

	University of Delhi, Delhi-110007	
2.	Prof. Somesh Kumar Shukla Department of Commerce, University of Lucknow, Lucknow-226001	w.e.f. 28.02.2019 to 27.02.2022
3.	Prof. Rohini Prasad Professor & Head, School of Studies in Economics, Pt.Ravishankar Shukla University,Raipur,Chhattisgarh-492010	w.e.f. 28.02.2019 to 27.02.2022
4.	Dr. Shailendra Singh Gaurav Professor & Head, Department of Genetics & Plant Breeding, Chaudhary Charan Singh University Campus, Meerut-250001	w.e.f. 28.02.2019 to 27.02.2022
ONE PERSON OF ACADEMIC EMINENCE TO BE NOMINATED BY THE CHIEF RECTOR; AND ;		
	Prof. Krishna B. Pandeya, 191-MIG-1, ADA Colony, Naini, Alld Ex-Vice-Chancellor, Nehru Gram Bhartiya Vishvidyalaya Kotwa-Jamnipur-Dubawal, Allahabad-221505	w.e.f. 08.02.2017 to 07.02.2020
ONE PERSON OF ACADEMIC EMINENCE TO BE NOMINATED BY THE CHANCELLOR.		
	-Vacant-	

The Academic Council (as of 31st March, 2019)

The Academic Council shall consist of the following members namely :-		
(a)	The Vice-Chancellor : Prof. Rattan Lal Hangloo (ex-officio Chairman)	
(b)	The Pro-Vice-Chancellor, if any: -Vacant-	
(c)	The Deans of the Faculties;	
	1.	Dean, Faculty of Arts
	2.	Dean, Faculty of Commerce
	3.	Dean, Faculty of Law
	4.	Dean, Faculty of Science
(d)	The Dean of Research and Development: Prof. S.I. Rizvi, Department of Biochemistry	
(e)	The Dean of Students Welfare; Prof. Harsh Kumar, Department of Ancient History	
(f)	The Dean of College Development; Prof. Pankaj Kumar, Deptt. of Political Science	
(g)	The Librarian Dr. B.K. Singh	
(h)	<i>Such Heads of Departments, Directors of the University Institutes and Heads of Centres not comprised in any University Institute, as are not members under sub-clauses (b) to (f); Provided that where a subject assigned to an Faculty is not placed under any Department, the Chairman of the Board of Studies of the subject shall be a member of the Academic Council in case he is not already a member under sub-clauses (b) to (g);</i>	
	<u>Heads of Departments</u>	
	1.	The Head, Department of Ancient History, Culture & Archaeology, A.U.
	2.	The Head, Department of Anthropology, A.U.
	3.	The Head, Department of Arabic and Persian, A.U.
	4.	The Head, Department of Education, A.U.
	5.	The Head, Department of English and Modern European Languages, A.U.
	6.	The Head, Department of Geography, A.U.
	7.	The Head, Department of Hindi and Modern Indian Languages, A.U.
	8.	The Head, Department of Journalism and Mass Communication, A.U.
	9.	The Head, Department of Medieval and Modern History, A.U.
	10.	The Head, Department of Music and Performing Arts, A.U.

UNIVERSITY OF ALLAHABAD

11.	The Head, Department of Philosophy, A.U.
12.	The Head, Department of Physical Education, A.U.
13.	The Head, Department of Political Science, A.U.
14.	The Head, Department of Psychology, A.U.
15.	The Head, Deptt. of Sanskrit; Pali, Prakrit and Oriental Languages, A.U.
16.	The Head, Department of Urdu, A.U.
17.	The Head, Department of Visual Arts, A.U.
18.	The Head, Department of Commerce and Business Administration, A.U.
19.	The Head, Department of Economics, A.U.
20.	The Head, Department of Law, A.U.
21.	The Head, Department of Botany, A.U.
22.	The Head, Department of Bio-Chemistry, A.U.
23.	The Head, Department of Chemistry, A.U.
24.	The Head, Department of Defence and Strategic Studies, A.U.
25.	The Head, Department of Earth and Planetary Sciences, A.U.
26.	The Head, Department of Electronics and Communication, A.U.
26.	The Head, Department of Home Science, A.U.
28.	The Head, Department of Mathematics, A.U.
29.	The Head, Department of Physics, A.U.
30.	The Head, Department of Statistics, A.U.
31.	The Head, Department of Zoology, A.U.
<u>Director of University Institutes</u>	
1.	The Institute of Inter-Disciplinary Studies Prof. Jagdamba Singh, Dean, Faculty of Science
2.	The Institute of Professional Studies Prof. Neelam Yadav, Centre for Food Technology, A.U.
3.	The National Centre of Experimental Mineralogy and Petrology Prof. J.K. Pati, Department of Earth & Planetary Science, A.U.
<u>Heads of Centres</u>	
1.	Centre of Behavioural and Cognitive Sciences Prof. Bhoomika Rastogi Kar
(i)	<i>One Professor, one Reader and one Lecturer from each Faculty, selected by rotation in the order of seniority of Professors, Readers or Lecturers as the case may be, of the concerned Faculty;</i>
<u>Faculty of Arts</u>	
Professor	Prof. K.S. Misra, Department of Education, A.U., Allahabad. (w.e.f. 04.09.2017 To 03.09.2020)
Reader	-Vacant-
Lecturer	Sri Sunil Umarao, Department of Journ. & Mass Comm., A.U. (w.e.f. 04.09.2017 To 03.09.2020)
<u>Faculty of Commerce</u>	
Professor	-Vacant-
Reader	Shri Javed Akhtar, Deptt. of Economics, A.U. (w.e.f. 20.09.2017 To 19.09.2020)
Lecturer	-Vacant- Due to services less than five years
<u>Faculty of Law</u>	
Professor	-Vacant-
Reader	-Vacant-
Lecturer	Dr. Roshan Lal, Department of Law, A.U., Allahabad. (w.e.f. 15.05.2018 To 14.05.2021)
<u>Faculty of Science</u>	
Professor	-Vacant-
Reader	Sri P.N. Gupta, Department of Electronics & Communication, A.U., Allahabad (w.e.f. 04.09.2017 To 03.09.2020)
Lecturer	Dr. Brajesh Kumar Sharma, Department of Mathematics, A.U., Allahabad (w.e.f. 04.09.2017 To 03.09.2020)
(j)	<u>The Director of Constituent Institutes; (Single Constituent Institute)</u>
1.	Prof. B.N. Tiwari, Director, G.B. Pant Social Science Institute, Allahabad.
(k)	<i>One Professor (not being Director) of each Constituent Institute, selected by rotation in the order of seniority;</i>

	1.	Prof. Bhaskar Majumdar , G.B. Pant Social Science Institute, Jhansi, Allahabad (w.e.f. 22-11-2016 To 21-11-2019)
(l)	<i>Two Principals of Constituent Colleges, selected by rotation in the order of length of substantive service as Principal;</i>	
	1.	Dr.(Smt.) Kamla Devi , Principal, Jagat Taran Girls Degree College, Allahabad (w.e.f. 22-11-2016 To 21-11-2019)
	2.	Dr. Anand Shankar Singh , Principal, Iswar Saran Degree College, Allahabad (w.e.f. 03.08.2017 To 02.08.2020)
(m)	<i>Two members of the academic staff (not being Principals) of Constituent Colleges from each group of subjects assigned to a faculty of the University, selected by rotation in order of seniority as such members of the Academic Staff of the concerned group of subject and</i>	
	1.	Dr. Amitabh Tiwari , Department of Economics, Allahabad Degree College, Allahabad. (w.e.f. 03-02-2018 To 02-02-2021)
	2.	-Vacant-
(n)	<i>Five persons, not being persons of academic excellence in the service of the University or a college or an institution admitted to the privileges of the University, to be co-opted by the Academic Council. The Vice-Chancellor nominated the following Five External Members of Academic Council for a term of three years (w.e.f.13-07-2016 To 12-07-2019) and reported in the Academic Council meeting vide Resolution No.30/27 dated 14-12-2016 :-</i>	
	1.	Prof.Ranjan Chakrabarti ,Vice-Chancellor,VidyasagarUniversity,Midnapore,WestBengal-721102.
	2.	Prof. Ashok Aima , Vice-Chancellor, Central University of Jammu, Bagla Raya Suchani, District-Samba, Jammu (Jammu & Kashmir).
	3.	ogesh Sharma , Central for Historical Studies, Jawaharlal Nehru University, New Delhi.
	4.	Prof. P.F. Rahaman , Head & Professor, Deptt. of Zoology, Maulana Azad National Urdu University Gachibowli, Hyderabad-500032
	5.	Prof. Sushma Yadav , Room No. 44, Indian Institute of Public Administration (IIPA), Indraprastha Estate, Ring Road, New Delhi-110002
<i>Following Coordinators included as a Special Invitee vide Academic Council Resolution No.35/27 dated 14-12-2016, and Executive Council Resolution No.18/42 dated 16-12-2016.</i>		
	1.	The Coordinator, K. Banerji Centre of Atmospheric and Ocean Studies, A.U., Allahabad
	2.	The Coordinator, Centre of Bio-Informatics, A.U., Allahabad
	3.	The Coordinator, Centre of Biotechnology, A.U., Allahabad
	4.	The Coordinator, Centre of Globalization Studies, A.U., Allahabad
	5.	The Coordinator, Centre of Material Sciences, A.U., Allahabad
	6.	The Coordinator, Centre of Nano Science and Nano Technology, A.U., Allahabad
	7.	The Coordinator, Centre of Women's Studies, A.U., Allahabad

Finance Committee:

1. Prof. Rattan Lal Hangloo, Vice Chancellor, UoA, Chairman
2. Mrs. Darshan Dabral, Joint Secretary and Financial Advisor, MHRD
3. Sri G. C. Husur, Joint Secretary, MHRD
4. Dr. J. K. Tripathi, Joint Secretary (CU), UGC
5. Prof. B. N. Tiwari, Director, G.B. Pant Social Sciences Institute
6. Prof. Furquan Qamar
7. Prof. Satya Narain, UoA

MISSION VISION OF THE UNIVERSITY

- The pursuit, advancement and generation of knowledge in all branches of learning, with particular stress on exploring their intersection and frontiers.
- The transmission of knowledge through teaching learning process.
- The application of knowledge to human and social advancement.
- The optimum mobilization of resources and infrastructure.
- The preparation of human resource of the highest possible quality, capability and motivation.
- To link the "World of Knowledge" with the "World of Work" through professional courses.
- To create conducive environment for focused learning.
- To provide world class infra-structure and facilities.
- To promote innovation and entrepreneurship.
- To engage with the society through out-reach activities and applied research.

MILESTONE OF THE UNIVERSITY

University of Allahabad has always occupied an esteemed place among the universities of India for over a century now. Established on 23rd September 1887, it is the fourth oldest university of India after Calcutta, Bombay and Madras University. The credit for conceiving a large Central College at Allahabad, eventually to develop into a University, is due to Sir William Muir, the then Lt. Governor of United Provinces. As a result of his initiative the foundation stone of the Muir Central College (named after him) was laid on December 9, 1873 by His Excellency Lord Northbrook. On September 23, 1887 Act XVIII was passed which established the Allahabad University. Allahabad University was a centrally-funded Affiliating University exercising jurisdiction over higher and secondary education in a wide area in northern and central India, comprising the present-day States of Uttar Pradesh, Uttarakhand, Madhya Pradesh, Chhattisgarh and Rajasthan and the Vidarbha region of Maharashtra. In 1905 it initiated teaching and research under its own aegis, by establishing the Departments of *Law* (1905), *Economics* (1908) *History* (1912), research fellowships, libraries and laboratories. The eminence of the faculty of its teaching Departments, the Muir Central College (the premier affiliate, founded in 1873 at Allahabad) and several other reputed Affiliated Colleges, earned high regard for the University within and outside India. Some of the Colleges themselves matured into Universities the Banaras Hindu University (1916), the Aligarh Muslim University (1920) and the Lucknow and Nagpur Universities (1920 and 1923).

The University was later reorganized as a provincially-funded unitary teaching University, comprising its own teaching Departments and the Departments of the Muir Central College (which was merged with the University). The other Affiliated Colleges were initially grouped under the External Wing of the University and then handed over (in 1927) to the newly-incorporated, University of Agra in 1927, and the responsibility for secondary education was transferred (in 1922) to the U. P Board of High School and Intermediate Education. In the ensuing three decades, under the stewardship of celebrated Vice-Chancellors (Sir Ganganatha Jha, Pt. Iqbal Narain Gurtu, Prof. Amaranatha Jha and Prof. Tara Chand) and the academic leadership of illustrious faculty, the University took determined steps to enlarge its intellectual and educational ambit and gave a lead in national emancipation. Several teachers and students played a prominent role in the national struggle, particularly from 1930, and the University solemnly recalls with pride the martyrdom of its student Lal Padmadhar Singh during the Quit India Movement.

The scholars who gave a distinctive flavour to the academic ambience of the University, from its first venture into teaching in 1905, are too numerous to be named individually, and included such legendary figures as Amaranatha Jha, Raghupati Sahai "Firaq", S. C. Deb and P. E. Dastoor (English), H. N. Randle, R. D. Ranade and A. C. Mukerji (Philosophy), L. F. Rushbrook Williams, Sir Shafaat Ahmad Khan, R. P. Tripathi (History), Syed Muhammad Ali Nami

and M. G. Zubaid Ahmad (Arabic and Persian), P. K. Acharya, Babu Ram Saxena and Kshetresh Chandra Chattopadhyaya (Sanskrit), Dharendra Verma, Devi Prasad Shukla and Ram Kumar Verma (Hindi), Syed M. Zamin Ali and Muhammad Hafiz Syed (Urdu), Beni Prasad, Tara Chand, Ishwari Prasad (all three being historians of repute) and A. B. Lal (Political Science), R. N. Dubey (Geography), P. S. Naidu (Education), Meghnad Saha, K. S. Krishnan, D. S. Kothari, Salig Ram Bhargava, R. N. Ghosh G. B. Deodhar and K Banerjee (Physics), N. R. Dhar, Satyeshwar Ghosh and Satya Prakash (Chemistry), A C. Banerji, Gorakh Prasad, P. L. Srivastava and B. N. Prasad (Mathematics), J. H. Mitter, Shri Ranjan, R. K. Saxena and R. N. Tandon (Botany), D. R. Bhattacharya and H. R. Mehra (Zoology), H. Stanley Jevons, S. K. Rudra, C. D. Thompson, B. P. Adarka and J. K. Mehta (Economics), M. K. Ghosh and R. C. Choudhury (Commerce) and J C. Weir, M. U. S. Jung, K. K. Bhattacharya, K. R. R. Sastry and T. N. Sapru (Law) During this "Golden Age", the University was often referred to as "The Oxford of the East".

With the advent of Independence, the University gave priority to the rising expectations of the people for wider access to higher education and keeping pace with the world in higher education, took up concerns crucial to national and social reconstruction. The Seventieth Anniversary Celebrations (1957) were marked by the affirmation to concert intellectual resources for exploring new academic, educational and social horizons while conserving its classical heritage. The Centenary Celebrations (1987) provided the opportunity to reaffirm the goal of academic modernization predicated on social responsibility

The University did, however, face difficulties in mobilising resources for the pursuit and fulfilment of its intents and objectives. This paved the way for a concerted campaign, which began with the Seventieth Anniversary and was re-invigorated from the Centenary Celebrations, for the re-incorporation of the University as a Central University. These efforts, which were immeasurably, strengthened by the support of the Alumni in different fields of national life, bore fruit in 2005, with the adoption by Parliament of "The University of Allahabad Act, 2005", and its enforcement on July 14, 2005.

This restoration of the original 'Central Status' has inaugurated a new Chapter in the evolution of the University, and occasioned a fresh resolve to realize its earlier stature as an internationally acclaimed institution of higher learning. The University is now poised for exploring new dimensions of institutional accomplishment, by renovating its academic system, reinforcing and augmenting its teaching, research and residential facilities and pursuing social purposes in a coordinated manner, to keep pace with international standards in these areas and endow human resource with the capabilities to serve the nation in the special context of the challenges and imperatives of globalization.

HIGHLIGHTS OF UNIVERSITY INITIATIVES

ACADEMICS

- Major steps have been taken to execute the academic vision plan of the University. The teaching and research in multi-disciplinary and cross-disciplinary areas of national importance was promoted.
- Steady reforms were brought about in examination and evaluation system with uniform implementation of the Choice Based Credit System (CBCS) in PG courses across all academic units of the University.
- Teachers of the constituent colleges were allowed to enrol PhD students under their supervision as per the UGC Guidelines.
- New PhD Ordinance of the University was formulated and approved by the competent University authorities.
- Eminent academician and social scientists were invited to deliver lecture under the Distinguished Lecture Series. The lectures were audio-video recorded and put on the University website.
- National and International Seminars were organized throughout the year in nearly all the academic units.
- University got connected with other Centres of advanced learning in the country as well as abroad through national and international collaborative arrangements and MoUs.
- Students of the University visited the Heidelberg University under the DBT sponsored Big Data Research.
- Continuous improvement in the student's performance was reflected through increase number in placements and selections in different jobs of the State and Central Governments as well as private organizations.
- Awards/recognitions have been given to outstanding students, teachers (including retired teachers) and non-teaching staff on the occasion of 15th August and 26th January.
- Procurement of new equipments in various departments was done through equipment grants.
- Timely and continuous monitoring of the progress of the research students has drastically improved the research standards and quality of Ph.D. programme of the University.
- Condition of the Central Library of the University has significantly improved in terms of collections of books and journals. The modernization of the library was ensured with the help of e-library. The plagiarism detection software as well as remote access facility was made available to faculty and students.
- Infrastructural development and augmentation for research facilities, uninterrupted power supply and other necessary facilities as well as constant encouragement and motivation by the academic leadership has resulted in quantum jump in number of research publications by the faculty members and students of the University.
- Many of the faculty members and students of the University bagged prestigious fellowships and awards of national and international importance.
- DST sponsored Neuro Imaging facility (functional MRI) at the Centre of Behavioural and Cognitive Sciences was inaugurated by the Hon'ble Minister of Science and Technology.
- NAAC Accreditation was carried out after a gap of 15 years.
- University has decided to hold the Convocation on 5th Sept 2019 after a gap of 15 years.

ADMINISTRATION AND FINANCE

- Permanent appointments of Faculty members were made in the Dept. of Hindi, Computer Science, Home Science, Globalization and Development Studies, Centre for Women Studies and Centre for Science and Society.
- The regular appointments of Assistant Professors were also made in the Constituent Colleges of the University.
- Several eligible faculty members of the University and Colleges were promoted under CAS.
- Regular appointments were made on the posts of Registrar, Finance Officer, Law Officer, and Information Scientist.
- The appointments process for filling up the vacant teaching and non-teaching positions of the University was started.

- The General Finance Rules (GFR)-2017 and its subsequent amendments were strictly followed.
- E-procurement (e-tendering and e-publishing) system and GeM were made fully functional in the University for procurement of good and services as well as for works. Most of the procurement was done through GeM.
- The VISAKA (Vittiya Saksharta Abhiyan) guidelines were implemented in the University.
- Financial Ledger was compiled on a daily basis to ensure maximum transparency and to curb corruption.
- The CCASH worked towards prompt relief to the complainants as per its guidelines.
- Zero tolerance was shown towards the financial malpractices and indiscipline of students and staff.
- University of Allahabad Alumni Association worked to extend the current alumni database. The active involvement of the Alumni was ensured for suggestions to improve the quality of teaching and research in the University.
- The University actively participated in all the Govt. of India initiatives such as Yoga Day, Run for Unity, Guru Purnima, Environment Day etc.

EFFECTIVE USE OF THE ICT FOR TEACHING, ADMISSIONS AND E- GOVERNANCE

- The University has conducted an all India Online Entrance Tests for UG, PG and DPhil courses for admission to various courses of study for the academic session 2018-19. This exercise helped the University to attract talented and potentially bright students from all over the country.
- The ICT enabled Smart Class Rooms have been established in several new departments for effective teaching-learning using modern aids.
- The bandwidth of the Campus wide LAN and Wi-Fi facility (available in the entire University campus as well as hostels) has been increased and its full uninterrupted utilization was largely ensured as per the mandate of NKN.
- The campus wide CCTV surveillance system with a modern centralized control room is functional in the University.
- The Automation process to the Finance and Registry was ensured in a phasewise manner.
- Full utilization of MHRD's digital initiative, namely, MOOCS and e-PG Pathshala on SWAYAM platform as well as GIAN scheme was ensured for e-learning and research.

INFRASTRUCTURE AND STUDENT AMENITIES

- Conservation and restoration of historic Vizayanagaram Hall & surrounding area was completed.
- Dilapidated Tilak Bhawan got fully renovated and maintained. The facility shall serve as a mini auditorium with a seating capacity of approx. 300 persons.
- University has carried out installation work of Solar panels of the capacity of 1.434 Mw.
- Construction of new girls hostel, boys hostel and International Hostel has been started.
- Repairing and upkeep work in the University Hostels has been carried out.
- Labs, classrooms, and departmental library of several departments of the University have been renovated.
- Senate Hall of the University was renovated to hold special lectures, functions, and seminars.
- Plantation of trees was carried out at regular intervals to make the campus as green as possible.
- Anti-ragging Cell as per UGC guidelines has been re-constituted and is made fully functional.
- NCC and NSS organized several activities throughout the year.
- Recreational and sports facilities have been upgraded in the campus.
- Freeships, Scholarships, Poor Boys fund, Merit cum means were distributed to economically vulnerable students.
- Jawahar Lal Nehru Centre for differently abled students of the University has been further equipped with state-of-the-art gadgets..

PHOTO GALLERY



Inauguration of National Neuroimaging Facility by Dr. Harsh Vardhan, Union Minister of Science and Technology, Govt of India on February 2, 2019 at Centre of Behavioral and Cognitive Sciences



Vice-Chancellor Prof. R. L. Hangloo welcomed Sri Harbansh Ji, Deputy Chairman, Rajya Sabha at the University



Award for Excellence distribution ceremony



Padmashree Ashok Bhagat (Baba Ji), social worker and leader of Swachh Bharat Abhiyaan campaign for the state of Jharkhand, being facilitated by the Hon'ble Vice Chancellor



Hon'ble Mr. Justice (retired) Sudhir Narain being facilitated by the Hon'ble Vice Chancellor



P. Murlidhar Rao as Keynote Speaker in the seminar '*Rashtravad Aur New India*' organised by the University on 2nd March, 2019, Hon'ble Vice Chancellor Prof. R. L. Hangloo presided over the programme



Celebration of International Yoga Day on 21st June, 2018



Nagrik Abhinandan of Vice-Chancellor Prof. R. L. Hangloo



Release of University Calendar on World Hindi Day 2018



Awareness campaign by NCC team at Sangam, Prayagraj



Exhibition on Kumbh 2019 at University of Allahabad



Celebration of Gandhi Jayanti in the University



Felicitation of Achievers by Chairman, Railway Recruitment Cell (NCR) and other Special Guests on Disability Day



Participants of placement drive organised by Placement Cell of the University



Interior part of renovated Vijiyanagaram Hall



Installation Solar panels for the capacity of 1.434 MW

FINANCE AT A GLANCE**University of Allahabad
Prayagraj****Consolidated Balance Sheet on 31-03-2019**

Amount Rs.

SOURCES OF FUNDS	Current Year	Previous Year
Corpus/Capital Fund	(985,530,046.66)	2,419,673,313.79
Designated/Earmarked/Endowment Funds	457,720,195.80	488,832,793.98
Current Liabilities and Provisions	5,052,077,790.55	2,195,871,910.99
TOTAL	4,527,019,586.01	5,106,866,992.36
APPLICATION OF FUNDS	Current Year	Previous Year
Fixed Assets		
Tangible Assets	2,177,176,224.11	1,367,112,383.71
Intangible Assets	3,949,991.48	9,470,613.46
Capital Work-in-Progress	952,168,995.00	1,462,568,373.00
Investments from Earmarked/Endowment Funds	202,827,764.00	190,720,390.00
Long Term		
Short Term		
Investments – Others	105,789,708.00	98,103,884.00
Current Assets	857,212,833.92	1,752,307,678.60
Loans/Advances & Deposits	227,894,069.50	226,583,669.59
TOTAL	4,527,019,586.01	5,106,866,992.36

Finance Officer

**University of Allahabad
Prayagraj**

Balance Sheet on 31-03-2019

Amount Rs.

SOURCES OF FUNDS	Schedule	Current Year	Previous Year
Corpus/Capital Fund	1	(1,379,792,986.55)	2,147,945,340.46
Designated/Earmarked Funds:	2	224,340,063.53	211,251,506.13
Current Liabilities and Provisions	3	5,052,077,790.55	2,195,871,910.99
TOTAL		3,896,624,867.53	4,555,068,757.58
APPLICATION OF FUNDS			
Fixed Assets			
Tangible Assets	4	1,856,497,307.43	1,156,617,260.43
Intangible Assets		3,949,991.48	9,470,613.46
Capital Work-in-Progress	4	952,168,795.00	1,462,568,373.00
Investments from Earmarked/Endowment Funds	5	202,827,764.00	190,720,390.00
Long Term			
Short Term			
Investments – Others			
Current Assets	6	105,789,708.00	98,103,384.00
Loans/Advances & Deposits	7	550,741,241.12	1,414,071,676.10
	8	224,649,860.50	223,516,560.59
TOTAL		3,896,624,867.53	4,555,068,757.58
Significant Accounting policies	23		
Notes on Accounts & Contingent Liabilities	24		

Finance Officer

University of Allahabad
Prayagraj

Income & Expenditure Account for the Year Ended 31-03-2019

Amount Rs.

Particulars	Schedule	Current Year	Previous Year
INCOME			
Academic Receipts	9	154,411,149.00	160,680,212.40
Grants & Donations	10	3,122,867,221.00	3,104,190,362.95
Income from investments	11	6,885,824.00	4,253,173.25
Interest earned	12	29,067,410.20	31,789,645.16
Other Income	13	40,786,124.03	43,057,107.65
Prior Period Income	14	-	37,700.00
TOTAL (A)		3,354,017,728.23	3,344,008,201.41
EXPENDITURE			
Staff Payments & Benefits (Establishment Expenses)	15	6,238,530,345.37	3,896,878,071.80
Academic Expenses	16	122,116,885.00	107,664,442.00
Administrative and General Expenses	17	325,704,984.62	247,871,643.50
Transportation Expenses	18	502,709.00	1,035,810.00
Repairs & Maintenance	19	33,869,802.00	21,190,842.00
Finance costs	20	90,344.19	212,544.01
Depreciation	4	186,610,379.00	111,535,502.93
Other Expenses	21	88,564,302.60	76,496,115.39
Prior Period Expenses	22	2,628,043.60	1,783,123.00
TOTAL (B)		6,998,617,795.38	4,464,668,094.63
Balance being excess of Income Over expenditure (A- B)			-
Transfer to/from Designated Fund (Specify each)			
Building Fund		-	-
Others (Specify)		-	-
Balance being surplus/(Deficit)Carried to Capital Fund		(3,644,600,067.15)	(1,120,659,893.22)
Significant Accounting policies	23		
Notes on Accounts & contingent Laibilities	24		

Finance Officer

University of Allahabad

Balance Sheet on 31-03-2019

(Relevant to Research Project)

Amount Rs.

CAPITAL FUND AND LIABILITIES	Schedule		Current Year	Previous Year
CAPITAL FUND				
Balance B/d		1 79,844,443.00		
Add: Grant utilised for creation of assets		131,567,655.68		1 79,844,443.00
Less : Depreciation on assets		18,384,863.00	293,027,235.68	
EARMARKED FUNDS/UNUTILISED GRANTS:				
Grants yet to be utilised	1		233,380,132.27	277,581,287.85
TOTAL			526,407,367.95	457,425,730.85
ASSETS				
FIXED ASSETS	2		293,027,235.68	1 79,844,443.00
CURRENT ASSETS	3		233,380,132.27	277,581,287.85
TOTAL			526,407,367.95	457,425,730.85

Finance Officer

University of Allahabad

Consolidated Balance Sheet on 31-03-2019

(Relevant to Institute of Professional Studies)

Amount Rs.

SOURCES OF FUNDS	Schedule	Current Year	Previous Year
Corpus/Capital Fund	1	101,235,704.21	91,883,530.33
Designated/Earmarked/Endowment Funds:			
Current Liabilities and Provisions	2	2,751,646.32	2,488,973.60
TOTAL		103,987,350.53	94,372,503.93
APPLICATION OF FUNDS	Schedule	Current Year	Previous Year
Fixed Assets			
Tangible Assets	3	27,651,681.00	30,650,680.28
Intangible Assets			
Capital Work-in-Progress			
Investments – Earmarked			
Investments-Other			
Current Assets	4	73,091,460.53	60,654,714.65
Loans, Advances & Deposits	5	3,244,209.00	3,067,109.00
TOTAL		103,987,350.53	94,372,503.93
Significant Accounting policies	23		
Notes on Accounts & Contingent Liabilities	24		

Finance Officer

ACADEMIC PROGRAMMES AND ADMISSIONS
(A) Ph.D. / PG Degree / UG Degree / Diploma / Certificate programmes

Ph.D.		PG Degree		UG Degree	
1.	Agricultural Botany	1.	M. A. (Ancient History)	1.	B.A.
2.	Agricultural Chemistry	2.	M. A. (Anthropology)	2.	B.Com.
3.	Ancient History	3.	M. A. (Defense Studies)	3.	B.Sc. (Maths)
4.	Anthropology	4.	M. A. (Economics)	4.	B.Sc. (Bio.)
5.	Arabic	5.	M. A. (Education)	5.	B.Sc. (Home Sc.)
6.	Atmospheric & Ocean Studies	6.	M. A. (English)	6.	B.Sc. Computer Sc.
7.	Behavioral and Cognitive Sciences	7.	M. A. (Geography)	7.	B.Tech. (ECE)
8.	Biochemistry	8.	M. A. (Hindi)	8.	B.Tech. (CSE)
9.	Bioinformatics	9.	M. A. (Mass Communication)	9.	B.P.A.
10.	Biotechnology	10.	M. A. (Mathematics)	10.	B.F.A.
11.	Botany	11.	M. A. (Med. & Modern History)	11.	B.A.LLB.
12.	Chemistry	12.	M.A. Music (Sitar, Tabla, Vocal)	12.	LLB.
13.	Commerce and Business Administration	13.	M. A. (Painting)	13.	BCA
14.	Computer Application (IPS)	14.	M.A. (Philosophy)	14.	B.A. (Media Studies)
15.	Defence and Strategic Studies	15.	M. A. (Political Science)	15.	B.A. (Fashion Design & Tech.)
16.	Development Studies	16.	M. A. (Psychology)	16.	B.Voc. (Media Studies)
17.	Earth and Planetary Sciences	17.	M. A. (Sanskrit)	17.	B.Voc. (Food Processing & Technology)
18.	Economics	18.	M. A. (Sociology)	18.	B.Voc. (Fashion Design & Tech.)
19.	Education	19.	M. A. (Statistics)		
20.	English	20.	M. A. (Urdu)	Diploma	
21.	Environmental Science	21.	M.Com.	1.	Ancient Iranian & Pahlavi
22.	Fine Arts	22.	LLM.	2.	Arabic
23.	Food Technology	23.	M. F. A. (Master in Fine Arts)	3.	Bengali
24.	Geography	24.	M.P.Ed.	4.	French
25.	Hindi	25.	M. Sc. (Anthropology)	5.	German
26.	History (Medieval and Modern)	26.	M. Sc. (Applied Geology)	6.	Hindi
27.	Home Science	27.	M.Sc. (Bio- Chemistry)	7.	Persian
28.	Law	28.	M. Sc. (Bioinformatics)	8.	Punjabi
29.	Material Science	29.	M.Sc. (Botany)	9.	Russian
30.	Mathematics	30.	M.Sc. (Chemistry)	10.	Tamil

Ph.D.		PG Degree		Diploma	
31.	Music and Performing Arts	31.	M. Sc. (Computer Science)	11.	Telugu
32.	Nutritional Sciences	32.	M.Sc. (Defense Studies)	12.	Urdu
33.	Persian	33.	M. Sc. (Environmental Science)	13.	Applied Arts & Crafts
34.	Philosophy	34.	M. Sc. (Geography)	14.	Indian Music (Jr)
35.	Physical Education	35.	M. Sc. (Mathematics)	15.	Indian Music (Sr)
36.	Physics	36.	M. Sc. (Physics)	16.	Painting
37.	Political Science	37.	M. Sc. (Psychology)		
38.	Psychology	38.	M. Sc. (Rural Tech & Dev.)	17.	Photography
39.	Sanskrit	39.	M. Sc. (Statistics)	18.	Archaeology
40.	Sociology	40.	M. Sc. (Textile and Apparel Designing)	19.	Criminology
41.	Statistics	41.	M. Sc. (Zoology)	20.	Gandhian Studies
42.	Urdu	42.	M. Tech. (Earth System Sc.)	21.	Indian Culture & Philosophy
43.	Zoology	43.	M. Tech (Electronics)	22.	Local Self-Govt. Administration
		44.	M.Tech (Comp. Tech.)	23.	PGDCA
		45.	M.A. (Arabic)	24.	2-year Advanced Diploma in Fashion Design & Tech.
		46.	M.A. (Development Studies)	25.	2-year Diploma in Computer Aided Fashion Design
		47.	M.A. (Persian)		
		48.	M.A. (Theatre & Film)		
		49.	MBA	Certificate	
		50.	M.Ed.	1.	Bengali
		51.	M.P.A. Mus. (Sitar, Tabla, Vocal)	2.	French
		52.	M.Sc. (Material Science)	3.	German
		53.	M.Sc.-Agri Science (Botany)	4.	Hindi
		54.	M.Sc.-Agri Science (Chemistry)	5.	Punjabi
		55.	M.Sc.-Agri Science (Zoology)	6.	Russian
		56.	M.Sc. (Food Technology)	7.	Sanskrit
		57.	M.Sc. (Nutritional Sciences)	8.	URDU
		58.	M.Voc. (Media Studies)	9.	Social Service & Village Uplift
		59.	M.Voc. (Fashion Design & Technology)	10.	Photography
		60.	MCA		

(B) Name of courses offered by the University

Under-Graduate Level	15 [B.A, B.A (Fashion Design & Technology), B.A (Media Studies), B.Mus, B.FA, B.PE, B.Ed*, B.Com, B.Sc, B.Sc (Home Science), B.Tech, B.CA, LL B, LLB (5 Year Integrated Programme), BVoc *NOTE: The B. Ed. Programme is offered in three Constituent Colleges, but not in the University Teaching Departments.
Post-Graduate Level	12[MA, MEd, MPed, MJMC, MMus, MCom, MBA, LLM, MSc, MTech, MCA, MVoc]
Research Degrees	04 [DPhil in Faculties of Arts, Commerce, Law and Science]

(C) Subjects Under Various Graduate and Post-graduate Degree Colleges

B. A.(General)	B. A. (Humanities)	B. A. (Social Sciences)	B. Sc. (Life Sciences)	B. Sc. (Physical Sciences)	PG Courses (M.A./M.Sc./M.Com.)
Ancient History	Ancient History	Anthropology	Anthropology	Chemistry	LLM
Economics	Arabic	Archaeology & Museology	Bio-Chemistry	ComputerScience	Botany
Education	English Language	Defence Studies	Botany	Computer Applications	Zoology
English Language	English Literature	Economics	Chemistry	Computer Maintenance	Physics
English Literature	Hindi	Education	Defence Studies	Defence Studies	Chemistry
Hindi	Functional Hindi	Geography	Zoology	Electronic Equipment Maintenance	Mathematics
Medieval History	Music –Instrumental (Sitar)	Mathematics		Geology	Commerce
Modern History	Music – Instrumental (Tabla)	Medieval History		Geography	Economics
Philosophy	Music – Vocal	Modern History		Mathematics	Ancient History
Political Science	Painting	Political Science		Photography	Education
Sanskrit	Persian Philosophy	Psychology		Physics	English
Urdu	Photography	Sociology		Psychology	Geography
	Sanskrit	Statistics		Statistics	Hindi
	Urdu	Office Management & Secretarial Practice			Medieval History
					Philosophy
					Political Science
					Sanskrit
					Sociology
(Total = 12)	(Total = 15)	(Total = 14)	(Total = 7)	(Total = 13)	(Total 18)

(D) Courses Offered by Constituent Colleges

Name of the College	Year	Character	Programmes Offered	NAAC Accreditation	Potential for Excellence
Chaudhary Mahadev Prasad Degree College	1950	Co-Educational	BA, BCom, BSc, LLB, M.A., M.Sc.	Yes	-
Ewing Christian College	1951	Co-Educational	BA, BSc, BEd, B.Voc. M.A., M.Sc.	Yes	Yes (Phase II)
Allahabad Degree College	1956	Co-Educational	BA, BCom, BSc, LLB	Yes	-

Name of the College	Year	Character	Programmes Offered	NAAC Accreditation	Potential for Excellence
Arya Kanya Girls Degree College	1975	Women	BA	Yes	-
Hamidia Girls Degree College	1975	Women	BA	Yes	-
Jagat Taran Girls Degree College	1975	Women	BA, BCom	Yes	Yes
Rajarshi Tandon Girls Degree College	1975	Women	BA	-	-
Sadanlal Sanwal Das Khanna Girls Degree College	1975	Women	BA, BCom, BSc, BEd	Yes	-
Isvar Saran Degree College	1977	Co-Educational	BA, BCom, BSc, M.A., B.Voc.	Yes	Yes
Shyama Prasad Mukherji Government Degree College	1997	Co-Educational	BA, BCom/, BSc	Yes	-
Kali Prasad Training College	1999	Co-Educational	BEd	-	-

(E) Self Financing Courses being Organised under the University of Allahabad and its Constituent Colleges

Certificate		Degree and Diploma	
Human Rights	UoA	B.A. OMSP	ECC
Computer Awareness	ECC	(Total = 01)	
Environmental Awareness	ECC	Degree	
Spoken English	ECC	B.A. Arch. and Museology	ECC
(Total = 04)		B.Sc. BTSP	ECC
Certificate/Diploma		B.Sc. Computer Application	ECC
Fashion Designing and Kasidakari	Hamidia Girls	B.Sc. Electronics	ECC
Translation Proficiency in Arabic	Hamidia Girls	B.Ed.	ECC/SSK Girls
Urdu Journalism and Mass Communication	Hamidia Girls	M.Sc. Environmental Science	UoA
(Total = 04)		B.A. LL.B. (Hons.) 5 Year Integrated Course	UoA

(F) Total Number of students in various UG, PG & Ph.D. Programmes (2018-19)

Course	General			OBC			SC			ST			PwD			TOTAL		
	Total	Male	Female	Total	Male	Female	Total	Male	Female	Total	Male	Female	Total	Male	Female	Total	Male	Female
U.G.	4351	3088	1263	6085	4685	1400	2757	2074	683	279	218	61	71	59	12	13472	10065	3407
P.G.	1870	917	953	2616	1517	1099	1185	758	427	120	87	33	53	42	11	5791	3279	2512
5 Yrs. Integrated Course	201	104	97	280	194	86	127	80	47	13	13	0	4	4	0	621	391	230
M.Phil/M.Tech	14	8	6	19	14	5	9	4	5	1	1	0	1	0	1	43	27	16
Ph.D	567	262	305	792	514	278	359	196	163	36	15	21	0	0	0	1754	987	767
Cert./Dip.	151	53	98	212	87	125	96	37	59	10	7	3	0	0	0	469	184	285
Total	7154	4432	2722	10004	7011	2993	4533	3149	1384	459	341	118	129	105	24	22150	14933	7217

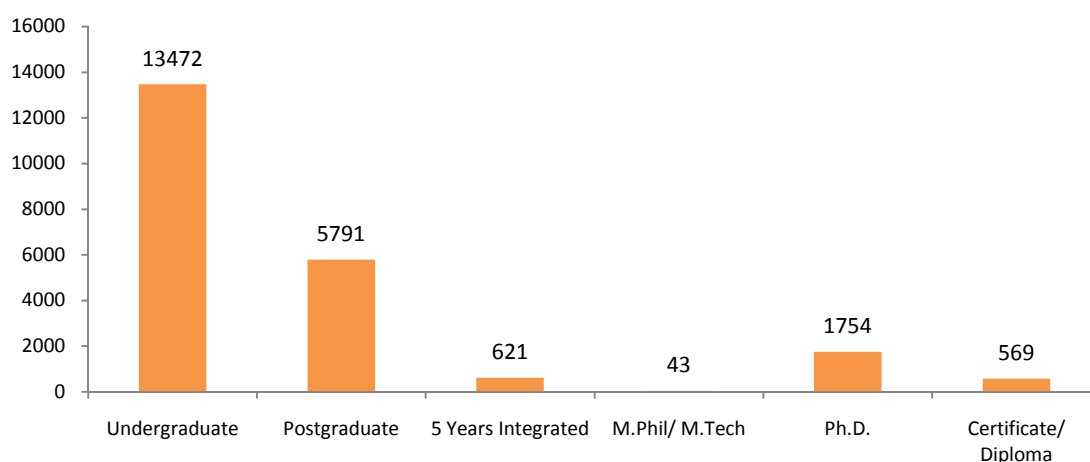

Total no. of students (Programme wise) 2018-19

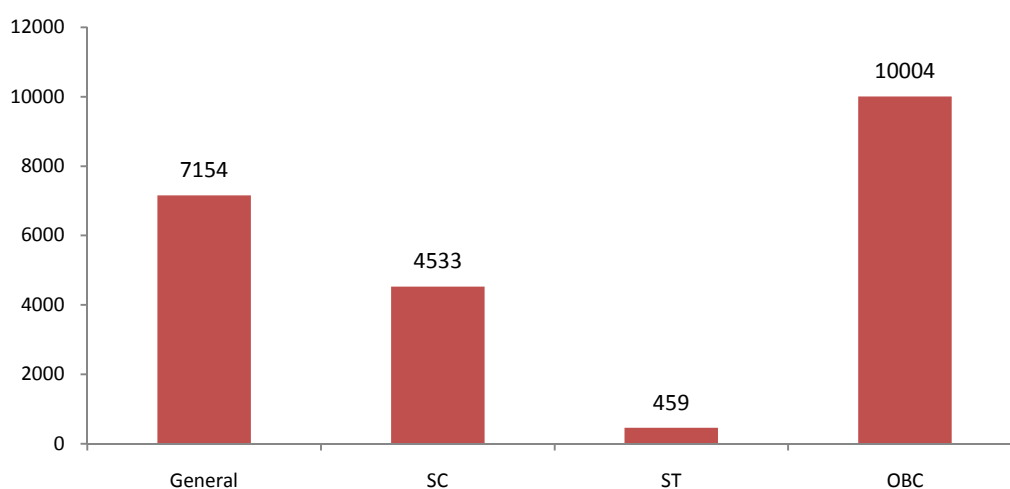

Total no. of students (category wise) 2018-19

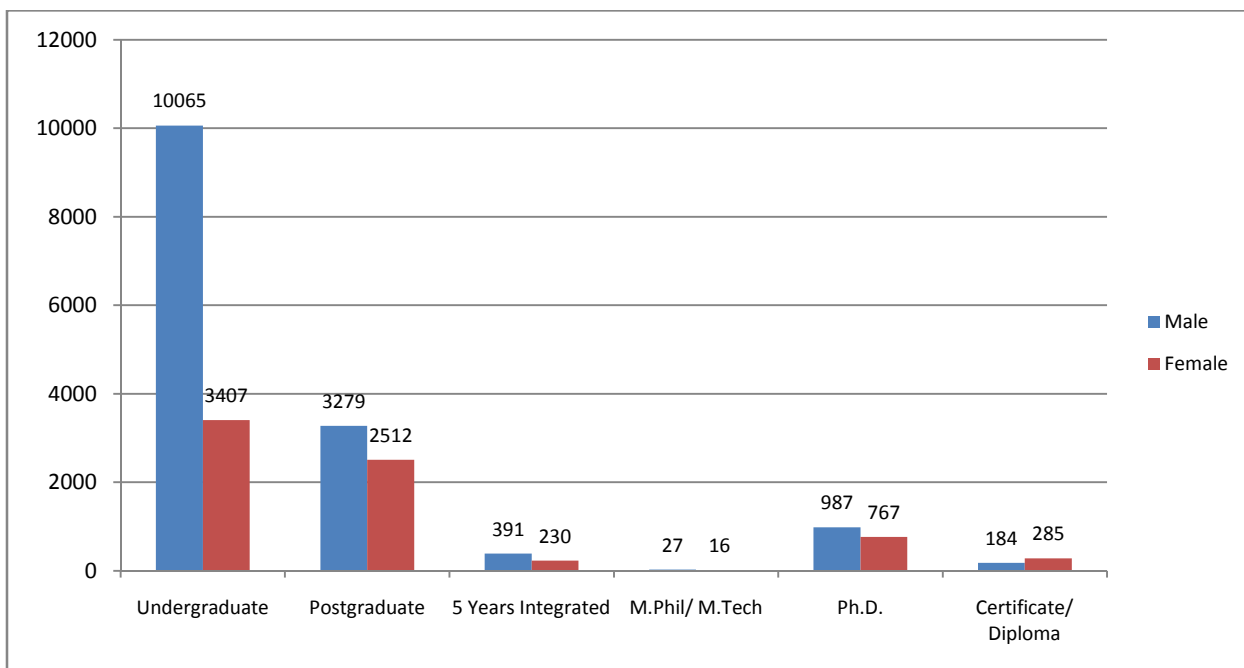

Total students (Gender wise) in various UG, PG & Ph.D. Programmes (2018-19)

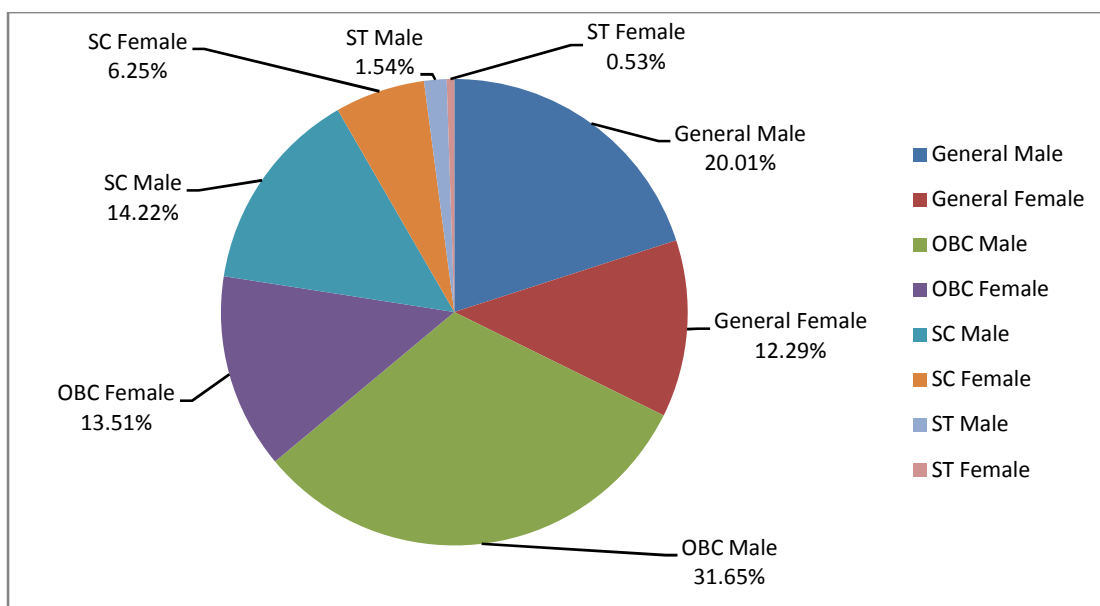

Category-wise and Gender wise distribution of total students in various UG, PG & Ph.D. Programmes (2018-19)

(G) Number of Undergraduate & Diploma Students Enrolled in 2018-19

Sl.No.	CLASS	TOTAL	GEN	OBC	SC	ST	PH	FN	Male	Female	Trnsgen
1.	B.A.	2741	723	1428	511	77	21	2	2213	528	-
2.	B.Com.	581	213	231	107	29	5	1	335	246	-
3.	B.Sc. (Bio)	270	100	95	57	18	2	-	119	151	-
4.	B.Sc. (Home Sc.)	42	11	19	11	1	-	-	0	42	-
5.	B.Sc. (Maths)	605	167	293	116	29	1	-	509	96	-
6.	B.Tech. (CSE)	39	16	16	6	1	-	-	36	4	-
7.	B.Tech. (ECE)	31	14	9	8	0	-	-	30	1	-
8.	BALLB	131	57	47	21	6	4	-	90	36	-
9.	LLB	306	111	123	48	24	5	-	273	33	-
10.	B.F.A.	61	13	34	13	1	-	-	27	34	-
11.	B.P.A.	32	14	16	2	0	-	-	22	10	-
12.	BCA	67	38	25	4	0	-	-	57	10	-
13.	B.A. (Media Studies)	41	28	8	5	0	-	-	25	16	-
14.	B.A. (Fashion Design & Tech.)	38	19	15	4	0	-	-	-	38	-
15.	B.Voc. (Food Technology)	23	10	11	2	0	-	-	13	10	-
16.	B.Voc. (Media Studies)	26	18	7	1	0	-	-	15	11	-
17.	B.Voc. (Fashion Design & Tech.)	15	8	6	1	0	-	-	-	15	-
18.	PGDCA	20	5	11	4	0	-	-	15	5	-
19.	2-year Advanced Diploma in Fashion Design & Tech.	15	9	4	2	0	-	-	0	15	-

(H) Number of Postgraduate Students Enrolled in 2018-19

Sl.No.	COURSE	TOTAL	GEN	OBC	SC	ST	PH	FN	Male	Female	Trnsgen
1.	M.A. (Ancient History)	141	37	66	35	3	-	-	108	33	-
2.	M.A. (Anthropology)	4	1	2	1	0	-	-	2	2	-
3.	M.A. (Applied Geology)	10	5	5	0	0	-	-	8	2	-
4.	M.A. (Arabic)	45	10	35	0	0	-	-	44	1	-
5.	M.A. (Defence Studies)	21	8	8	5	0	-	-	18	3	-
6.	M.A. (Economics)	128	44	57	24	3	-	-	97	31	-
7.	M.A. (Education)	31	8	16	6	1	-	-	19	12	-
8.	M.A. (English Language)	14	8	4	2	0	-	-	9	5	-
9.	M.A. (English Lit.)	226	83	96	46	1	-	-	134	92	-
10.	M.A. (Geography)	112	32	55	22	3	-	-	102	10	-
11.	M.A. (Hindi)	276	75	131	65	5	-	-	204	72	-
12.	M.A. (Mass Comm)	41	19	15	6	1	-	-	39	2	-
13.	M.A. (Med. & Mod History)	138	43	62	32	1	-	-	109	28	-
14.	M.A. Music (Sitar)	1	0	1	0	0	-	-	0	1	-
15.	M.A. Music (Tabla)	8	3	5	0	0	-	-	0	8	-
16.	M.A. Music (Vocal)	16	8	7	1	0	-	-	0	16	-
17.	M.A. (Painting)	31	5	19	7	0	-	-	14	17	-
18.	M.A. (Persian)	37	14	23	0	0	-	-	81	0	-
19.	M.A. (Philosophy)	81	39	25	17	0	-	-	53	28	-
20.	M.A. (Political Science)	119	37	51	26	5	-	-	102	17	-
21.	M.A. (Psychology)	39	22	11	5	1	-	-	28	11	-

UNIVERSITY OF ALLAHABAD

Sl.No.	COURSE	TOTAL	GEN	OBC	SC	ST	PH	FN	Male	Female	Trnsngen
22.	M.A. (Sanskrit)	134	68	37	29	0	-	-	73	61	-
23.	M.A. (Sociology)	28	12	10	5	1	-	-	20	8	-
24.	M.A. (Statistics)	44	10	11	1	22	-	-	13	9	-
25.	M.A. (Theatre & Film)	4	1	2	1	0	-	-	3	1	-
26.	M.A. (Urdu)	63	12	51	0	0	-	-	24	39	-
27.	M.A. (Zoology)	58	16	25	12	5	-	-	21	38	-
28.	MCA	22	11	11	0	0	-	-	14	8	-
29.	M.Com.	250	101	89	54	6	-	-	120	130	-
30.	M.Ed.	54	18	20	16	0	-	-	26	28	-
31.	MFA (Master of Fine Arts)	6	2	2	2	0	-	-	3	3	-
32.	MPA (Tabla)	2	0	1	1	0	-	-	2	0	-
33.	MPA (Vocal)	15	6	5	4	0	-	-	8	7	-
34.	MBA	48	21	17	7	3	-	-	37	11	-
35.	LLM	66	30	22	9	5	2	-	52	14	-
36.	M.Sc. (BioChem)	17	7	10	0	0	-	-	2	15	-
37.	M.Sc. (Bio-Info)	8	7	0	1	0	-	-	3	5	-
38.	M.Sc. (Chemistry)	104	36	47	17	4	-	-	63	41	-
39.	M.Sc. (Computer Sc)	30	9	14	7	0	-	-	17	13	-
40.	M.Sc. (Design & Inno in Rural Tech)	13	8	4	1	0	-	-	9	4	-
41.	M.Sc. (Environmental Sc.)	22	11	8	2	0	-	1	10	12	-
42.	M.Sc. (Material Sc.)	10	8	2	0	0	-	-	7	3	-
43.	M.Sc. (Biochemistry)	17	7	10	0	0	-	-	2	15	-
44.	M.Sc. (Agricultural Botany)	15	1	11	3	0	-	-	15	0	-
45.	M.Sc. (Agricultural Chemistry)	17	2	10	5	0	-	-	16	1	-
46.	M.Sc. (Agricultural Zoology)	12	2	7	3	0	-	-	12	0	-
47.	M.Sc. (Text. & App. Design)	16	6	9	1	0	-	-	0	16	-
48.	M.Tech. (Earth System Science)	22	2	9	0	11	-	-	8	3	-
49.	Master in Dev. Studies (MDS)	16	6	6	4	0	-	-	14	2	-
50.	M.Sc. (Mathematics)	153	47	68	35	3	-	-	109	44	-
51.	M.Sc. (Physics)	9	1	7	1	0	-	-	9	0	-
52.	M.Sc. (Physics)	57	15	28	12	2	-	-	38	19	-
53.	M.Tech. (Computer Sc.)	14	11	3	0	0	-	-	10	4	-
54.	Women Studies	19	12	6	1	0	-	-	11	8	-
55.	M.Sc. (Food Technology)	54	25	22	7	0	-	-	29	25	-
56.	M.Sc. (Nutritional Science)	25	10	10	3	2	-	-	3	22	-
57.	M.Voc. (Media Studies)	26	18	7	1	0	-	-	15	11	-
58.	MCA (IPS)	32	20	12	0	0	-	-	24	8	-

FACULTY POSITIONS: AT A GLANCE (as on 31-03-2019)

S.N.	DEPARTMENT/DISCIPLINE	Sanctioned Post			Total	Post Filled			Total	Vacant Post			Total
		Prof.	Asso. P.	Asst. P.		Prof.	Asso. P.	Asst. P.		Prof.	Asso. P.	Asst. P.	
1.	Ancient History Culture & Archeology.	5	12	21	38	0	1	8	9	5	11	13	29
2.	Anthropology	1	2	5	8	1	0	4	5	0	2	1	3
3.	Arabic/Persian	1	2	8	11	0	0	3	3	1	2	5	8
4.	Atmospheric & Ocean Studies	1	2	4	7	1	1	4	6	0	1	0	1
5.	Behavioral and Cognitive Sciences	2	4	5	11	1	1	2	4	1	3	3	7
6.	Bio-chemistry	2	1	6	9	1	1	5	7	1	0	1	2
7.	Bio-Informatics	1	2	5	8	0	0	2	2	1	2	3	6
8.	Bio-technology	1	2	5	8	1	1	3	5	0	1	2	3
9.	Botany	2	8	21	31	0	0	11	11	2	8	10	20
10.	Chemistry	5	10	35	50	0	2	7	9	5	8	28	41
11.	Commerce & Business Administ.	3	8	30	41	0	1	17	18	3	7	13	23
12.	Computer Education & Tranning	0	2	3	5	0	0	0	0	0	2	3	5
13.	Defence and Strategic Studies	2	3	7	12	0	1	5	6	2	2	2	6
14.	Earth & Planetary Science	2	1	6	9	0	1	6	7	2	0	0	2
15.	Economics	2	8	22	32	0	2	11	13	2	6	11	19
16.	Education	2	7	17	26	1	1	6	8	1	6	11	18
17.	Elect. & Communication	4	13	28	45	0	2	18	20	4	11	10	25
18.	English & Mod. European Languages	2	15	28	45	0	4	13	17	2	11	15	28
19.	Environmental Studies	1	2	4	7	0	0	2	2	1	2	2	5
20.	Experimental Mineralogy & Petrology	0	0	3	3	0	0	0	0	0	0	3	3
21.	Film & Theater Inst.	0	0	3	3	0	0	0	0	0	0	3	3
22.	Food Technology	1	2	4	7	0	1	2	3	1	1	2	4
23.	Gandhi Studies	0	0	3	3	0	0	0	0	0	0	3	3
24.	Geography	1	4	15	20	0	0	5	5	1	4	10	15
25.	Globalization & Devl. Studies	1	1	5	7	1	1	4	6	0	0	1	1
26.	Hindi & Modern Indian Languages	3	10	29	42	3	8	26	37	0	2	3	5
27.	Home Science	1	2	8	11	0	1	6	7	1	1	2	4
28.	Indian Diaspora	0	1	1	2	0	0	0	0	0	1	1	2
29.	Journalism and Mass Communication	1	0	6	7	0	0	1	1	1	0	5	6
30.	Languages	0	0	4	4	0	0	0	0	0	0	4	4
31.	Law	3	7	24	34	0	4	11	15	3	3	13	19
32.	Material Science	1	1	4	6	0	1	4	5	1	0	0	1
33.	Mathematics	2	8	21	31	0	1	10	11	2	7	11	20
34.	Medieval and Modern History	3	7	21	31	0	0	8	8	3	7	13	23
35.	Music and performing Arts	2	1	8	11	1	0	5	6	1	1	3	5
36.	Nano Science & Technology	0	1	2	3	0	0	0	0	0	1	2	3

UNIVERSITY OF ALLAHABAD

S.N.	DEPARTMENT/DISCIPLINE	Sanctioned Post			Total	Post Filled			Total	Vacant Post			Total
		Prof.	Asso. P.	Asst. P.		Prof.	Asso. P.	Asst. P.		Prof.	Asso. P.	Asst. P.	
37.	Philosophy	2	4	17	23	1	2	3	6	1	2	14	17
38.	Physical Education	1	3	8	12	0	0	2	2	1	3	6	10
39.	Physics	4	10	27	41	1	1	7	9	3	9	20	32
40.	Photo Journalism & Visual Comm.	0	1	2	3	0	0	0	0	0	1	2	3
41.	Political Science	2	8	20	30	0	2	7	9	2	6	13	21
42.	Psychology	3	9	8	20	0	1	5	6	3	8	3	14
43.	Sanskrit	2	5	21	28	0	1	3	4	2	4	18	24
44.	Science and Society (Rul.Tech.)	0	1	2	3	0	1	2	3	0	0	0	0
45.	Sociology	1	1	5	7	0	1	2	3	1	0	3	4
46.	South Asia & International Studies	0	0	3	3	0	0	0	0	0	0	3	3
47.	Space Studies	0	1	2	3	0	0	0	0	0	1	2	3
48.	Statistics	1	2	5	8	0	0	4	4	1	2	1	4
49.	Urdu	2	3	8	13	0	1	4	5	2	2	4	8
50.	Visual Art	1	0	5	6	0	0	0	0	1	0	5	6
51.	Zoology	2	6	22	30	0	1	4	5	2	5	18	25
	Total	79	203	576	858	13	47	252	312	66	156	324	546

Sanctioned Post	858
Sanctioned Floating position	5
Total Sanctioned Post	863
Total Filled Position	312
Total Vacant Position	546
Vacant Floating position	5
Total Vacant Post	551

FACULTY OF ARTS

DEPARTMENT OF ANCIENT HISTORY, CULTURE & ARCHAEOLOGY

Introduction:

The Department was founded in 1955 with the objective of promoting research and teaching in Ancient History (including pre-history and proto-history) and ancient world civilizations. The Department excavated the world famous archaeological site of Kaushambi from 1948 to 1964 with outstanding results. The Department was chosen for Special Assistance Programme (SAP) by the UGC for three consecutive phases from 1981 to 1995. It was also granted the status of Centre of Advance Study (CAS) from 2001 to 2006. The Department carried out International Collaborations with a) University of California, Berkeley (1980-82), b) Soviet Union on the Project “Comparative Archaeology and Ethno-Linguistic Studies” (beginning in 1980), c) Australian Research Council (2005-2008)

Departmental museum (Prof. G.R. Sharma Memorial Museum) houses a unique collection of antiquities spanning from Prehistory to early medieval period. Research/Scientific analysis is being carried out on different antiquities and artifacts. The department has archaeological research laboratories, a Photography Unit, A drawing Section, Libraries (PG, as well as, Research) and a Publication Unit.

Department has following facilities:

- **G.R. Sharma Memorial Museum** developed out of cultural material recovered mainly through excavations and explorations in the Northern Vindhya and the Middle Ganga Plains by the archaeologists of the Department.
- **Experimental Archaeology Lab:** Since its inception, January 2010, the lab has had been engaged in understanding **Cognitive Ecosystem of archaeological landscape** combining the results of the various scientific experimental techniques:
- **Archaeo-Zoological Lab for Archaeozoological Researches, Departmental Research and PG Library, Lab of Archaeological Chemistry, Photographic Lab, Surveying Drawing Lab, Computer Reprographic Lab**

Thrust Areas:

1. The Department has two thrust areas of research-Archaeology and Socio-Economic History – as recognized by the UGC during SAP and CAS (Phase I) programmes.
2. At the Postgraduate level, the department has the following areas of specializations:
 - a) Archaeology,
 - b) Art & Architecture,
 - c) Socio-Economic History and
 - d) Religion and Philosophy

Programmes of Study

S.N.	Programme of Study	Duration	Specialization(s)
1.	Ph.D.	5 years (includes Course Work)	Archaeology, Socio-Economic History, Culture, Art & Architecture, Religion & Philosophy
2.	M.A.	2 years (CBCS - 4 Semester)	Archaeology, Socio-Economic History, Culture, Art & Architecture and Religion & Philosophy
3.	B.A.	3 Years	Ancient History, Culture and Archaeology

Faculty Members and their Area of Research

Sl.N.	Name	Gender	Designation	Area of Specializations/Research
1.	Dr. A.P. Ojha (Head)	M	Professor	Socio-economic History, Indian Culture
2.	Dr. Anamika Roy	F	Professor	Art History, Epigraphy and Religion
3.	Dr. C.D. Pandey	M	Professor	Indian Culture, Religion & Philosophy

UNIVERSITY OF ALLAHABAD

Sl.N.	Name	Gender	Designation	Area of Specializations/Research
4.	Dr. D.P. Dubey	M	Professor	Religion & Philosophy, Palaeography
5.	Dr. Prakash Sinha	M	Professor	Archaeology
6.	Dr. Pushpa Tiwari	F	Professor	Indian Art & Architecture
7.	Dr. Ranjana Bajpai	F	Professor	Social History
8.	Dr. Harsh Kumar	M	Professor	Puranic Studies & Numismatics
9.	Dr. S.K. Rai	M	Professor	Social History
10.	Dr. Suniti Pandey	F	Professor	Art & Architecture

Support Staff: (Class-III)

Sl.N.	Name	Gender	Cat.	Designation	Work Assigned
1.	Sri T.P. Singh	M	OBC	Senior Office Assistant	Research and Office work
2.	Sri Mohan Chandra Joshi	M	GEN	Junior Office Assistant	Office Work and Examination Work
3.	Sri Anmol Arora	M	GEN	Personal Assistant	Office, Examination and Computer work
4.	Sri Satish Chandra Rai	M	GEN	Assistant Librarian	Library Work
5.	Sri Kamlesh Kumar	M	OBC	Draughtsman	Drawing Work
6.	Dr. Sushil Kumar Trivedi	M	GEN	Chemical Assistant	P.G. Library and P.G. Admission Work
7.	Sri Rajesh Patel	M	OBC	Driver	Attached to Head
8.	Sri Gulab Chandra	M	SC	Peon	In office work
9.	Sri Rajesh Kumar Yadav	M	OBC	Antiquity Marker	To maintain equipment from field work
10.	Sri Uma Shankar	M	OBC	Peon	In office work
11.	Sri Sriprakash	M	GEN	Book Attendant	Library work
12.	Smt. Guddi Devi	F	OBC	Peon	In office work
13.	Sri Shankar Lal Gaur	M	OBC	Peon	In office work

Details of Students, Programme wise and Reservation wise (2018-19):

Course	Gen			OBC			SC			ST			PwD			TOTAL		
	Male	Female	Total	Male	Female	Total	Male	Female	Total	Male	Female	Total	Male	Female	Total	Male	Female	Total
Ph.D.	4	2	6	-	2	2	-	1	1	-	-	-	1	-	1	5	5	10
PG	39	04	43	49	8	57	27	06	33	04	1	05	-	-	-	119	19	138
UG	243	64	307	427	85	512	157	46	203	37	5	42	-	-	-	864	200	1064
TOTAL	286	70	356	476	95	571	184	52	236	41	6	47	-	-	-	988	224	1212

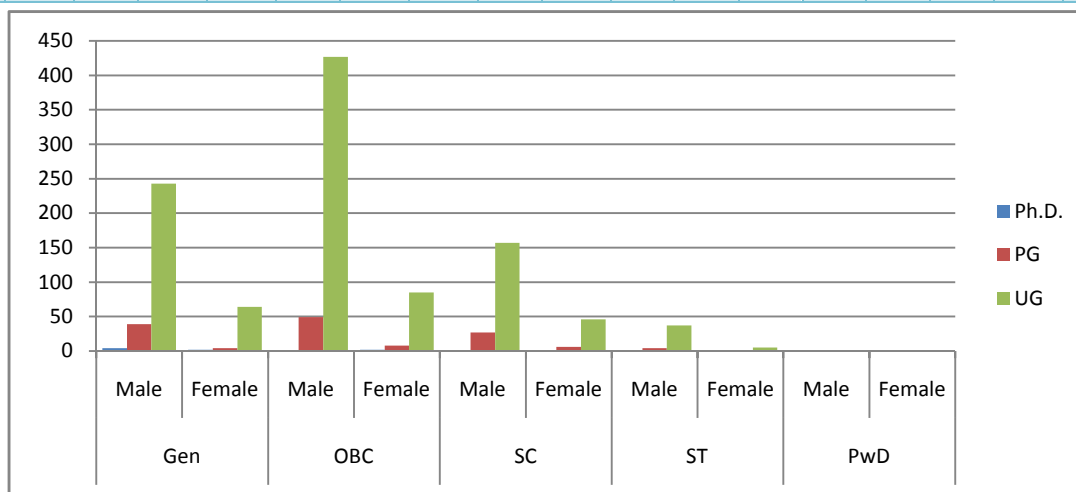

Student Enrollment for the Department

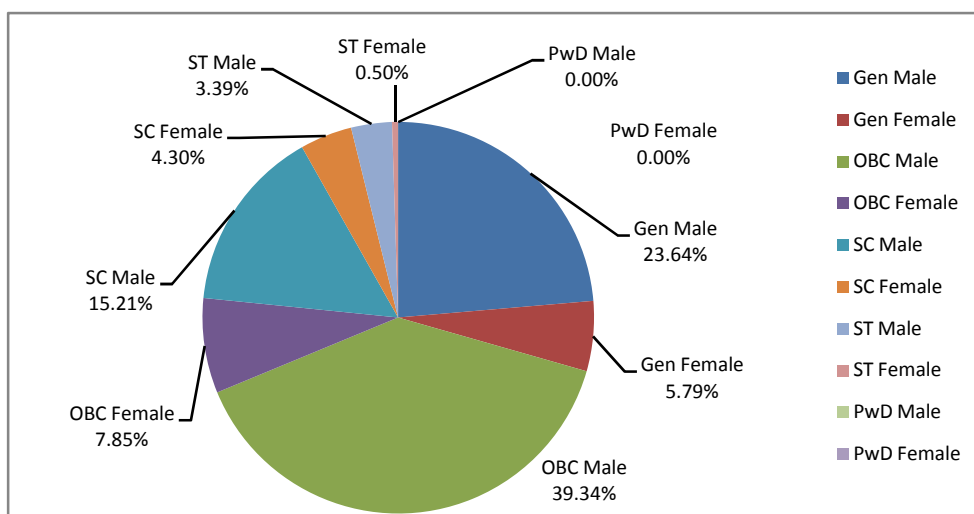

Gender wise distribution of Students

Training/orientation/refresher courses/special lectures conducted by the Department:

S.N.	Name of the course	Duration and dates	Speakers
1.	Special Lecture on: “Indus Civilization - New Discoveries”.	16 March, 2019	Dr. D. P. Sharma Ex- Director, Bharat Kala Bhawan, BHU, Varanasi

Awards/Honours/Fellowship received:

S. No.	Name of Faculty Member/ Student who received award	Name of the award	Organization conferring award
1.	Prof. A. P. Ojha	Sectional President , Ancient Indian History 29 th Session	U.P. History Congress, Lucknow, 2018

- Prof. A.P. Ojha Presided over a Session in International Seminar on “Prayag Kumbha: Cultural Heritage of the World” held at Vigyan Parishad Allahabad on 29-30 November, 2018
- Prof. Anamika Roy Presided over a session in the seminar on Jain Inscriptions held at Parshvanath Jain Institute, Varanasi.
- Prof. Anamika Roy delivered Two Lectures in Art Appreciation Workshop on “Amaravati Art” in Indian Museum, Calcutta on 16th and 17th July, 2018.
- Prof. Anamika Roy delivered one lecture in Centre for historical Studies, J.N.U. on “Art of Amaravati” on 28th September, 2018



Special Lecture on Indus Civilization – New Discoveries by Former Director Bharat Kala Bhawan, BHU, Varanasi

DEPARTMENT OF ANTHROPOLOGY

Introduction:

The Department of Anthropology was established in the year 1985 and was seated in the Senate House Building of the University. In year 2003 it was shifted to the ground floor of the Banda Guest House building in the University. The Department was again shifted in 2016 to the first floor of the newly constructed academic building of the University called New Academic Complex.

For more than three decades the Department of Anthropology has contributed immensely to the academic environment of the university. The Department provides education at both UG and PG levels and trains Ph.D.s in Anthropology who later become scholars working in academic and development sectors all over the country. Our graduates are working across various sectors such as state civil services, central civil services, public sector units, academics as well as development sectors.

Academic rigour and theoretical analysis marks the books written by the AU anthropologists. Stalwarts like Prof. ARN Srivastava and Prof. Vijay Sahay are witness to this intellectual tradition who have major contributions to the field of Anthropology. At present we have faculty members who have a modern approach to teaching and research representing a range of contemporary research interests spanning from tribal issues to anthropology of body. Our faculty members are busy researching some of the most burning issues of our time such as culture of consumption, anthropology of disaster, mental health and culture, forensic anthropology, socio-biology, tribal health, gender, etc. The most typical feature of anthropological courses is the mandatory exposure to fieldwork where our students are trained with modern research tools and techniques in the field of anthropology. Our faculty members have published research papers in many referred national and international journals.

Thrust Areas:

- Theories of Culture And Society
- Research Methodology
- Medical Anthropology
- Development and Society
- Bio-cultural aspects of human health
- Reproductive health
- Climate change
- Demography
- Aging.
- Issues of Marginalization
- Social Exclusion
- Sustainability
- Extreme Events
- Gender and Health.

Programmes of Study:

S.No.	Programme of Study	Duration	No. of Seats
1.	Ph.D.	5 years (includes course work)	25 (total students enrolled)
2.	M. A./M. Sc.	2 Years	30 +30
3.	B. A./B. Sc.	3 Years	50+50+50

Faculty members and their Area of Research:

S.N.	Name of Faculty	Designation	Area of Specialization
1.	Dr. Khirod Ch. Moharana	Assistant Professor	Medical Anthropology, Mental Health and Society, Climate Change, Anthropology of Consumption, Anthropology of Body.
2.	Dr. Prashant Khattri	Assistant Professor	Extreme Events and Environmental Marginalization
3.	Dr. RAHUL PATEL	Assistant Professor	Medical Anthropology, Social-Cultural Anthropology, Tribal Studies, Indigenous Knowledge

S.N.	Name of Faculty	Designation	Area of Specialization
4.	Dr. Ruma Purkait	Professor-CDR	Forensic Anthropology, Biometrics, Disaster Victim Identification, Human Growth & Development, Dermatoglyphics
5.	Dr. Shailendra Kumar Mishra	Assistant Professor	Biological Anthropology
6.	Dr. V. K. Rai	Professor and Head	

Support Staff:

S.N.	Name	Gender	Category	Designation
1.	Amitabh Keshri	Male	General	Office Assistant
2.	Prem Chand	Male	SC	Peon
3	Swaminath Yadav	Male	OBC	Peon

Details of Students, Programme wise and Reservation wise (2018-2019):

Course	Gen			OBC			SC			ST			PwD			TOTAL		
	Male	Female	Total	Male	Female	Total	Male	Female	Total	Male	Female	Total	Male	Female	Total	Male	Female	Total
Ph.D.	06	07	13	03	03	06	03	01	04	00	00	00	01	00	01	13	11	24
PG	10	03	13	07	01	08	05	01	06	00	00	00	00	00	00	22	05	27
UG	27	20	37	36	13	49	11	04	15	02	00	02	00	00	00	76	37	113
Total	43	30	63	46	17	63	19	6	25	2	0	2	1	0	1	111	53	164

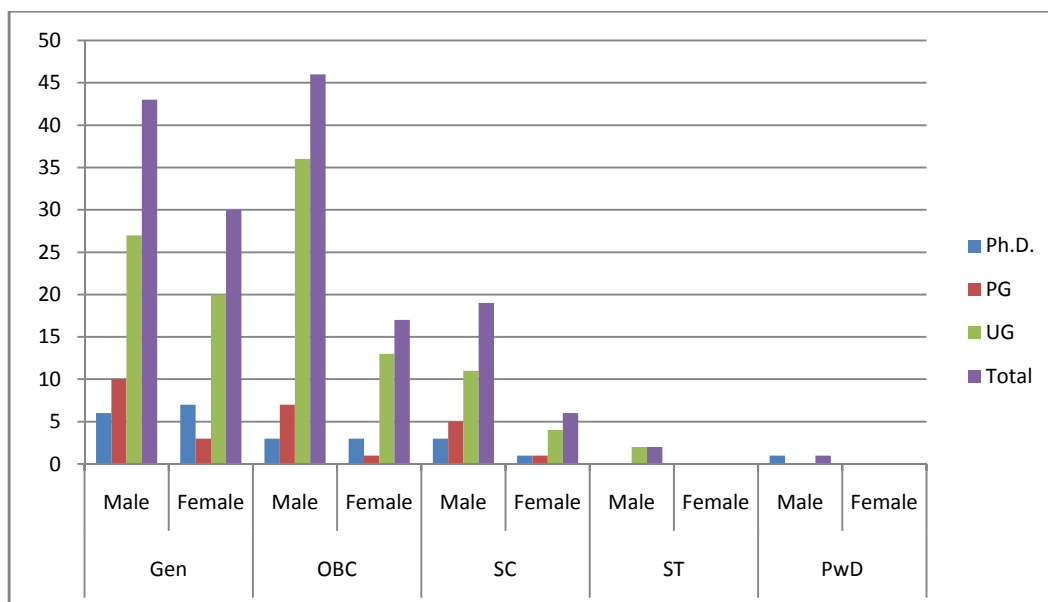

Student Enrollment for the Department

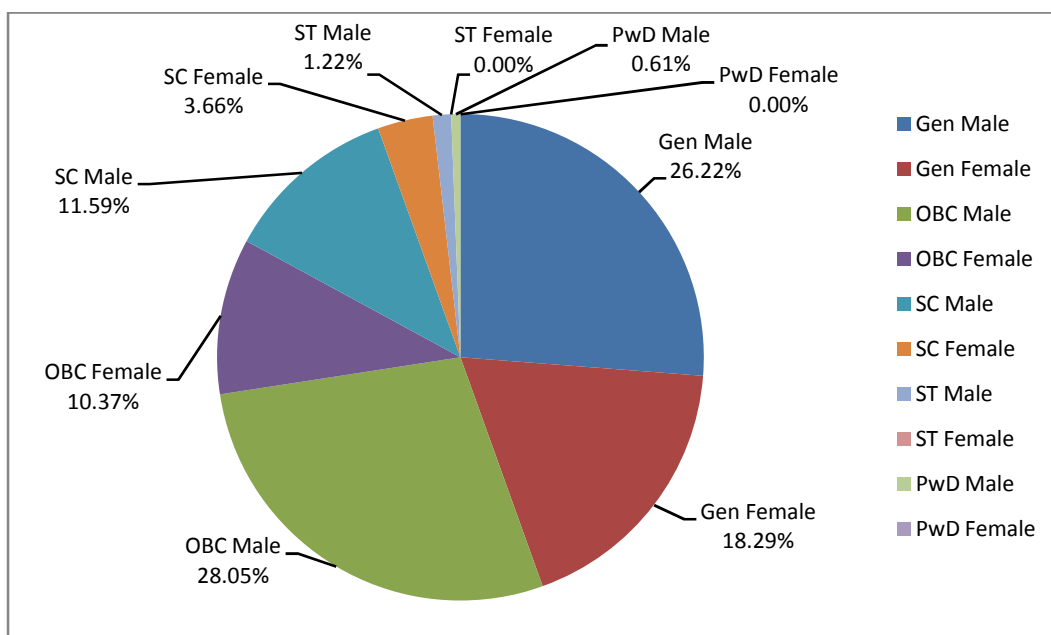

Gender wise distribution of Students

Training/orientation/refresher courses/special lectures conducted by the Department/Centre:

S. No.	Name of the course	Duration and dates	Speakers
1.	A special lecture on Article 35-A in November 2018		Dileep Dubey Senior Advocate, Supreme Court of India
2.	Public lecture on “Gandhi and Diaspora: Some Explorations”	25 January 2019	Prof. Chandrasekhar Bhat, Hyderabad Central University
3.	Special Lecture on “Social Theory and Ethnography	1 st February 2019	Prof. Anant Giri, Madras Institute of Development Studies
4.	3 rd L P Vidyarthi Memorial Lecture	28 th February 2019	Prof. Badrinarayan, Director, GBPSSI, Allahabad
5.	Jammu-Kashmir Issue and Role of Sharda Peeth”	February 22, 2019	Shankaracharya Amritananda Devteerth

DEPARTMENT OF ARABIC AND PERSIAN

Introduction:

The Department of Arabic and Persian was established in 1872 along with Muir Central College. The renowned scholar Maulvi Zakauallah was the founder of the Department. Some of the distinguished faculty members are:

- Moulvi Amjad Ali
- Prof. Mahdi Hasan Nasiri
- Prof. Mohmmad Ali Nami
- Prof. Saeed Hasan
- Prof. M. Rafique
- Prof. Ijtiba Nadwi
- Prof. A.Q. Jafari
- Prof. Saleha Rasheed

Thrust Areas:

- Imparting students with the skills, knowledge, and values that contribute in all walks of personal, professional, and social life
- Achieving excellence in the fields of manuscriptology, and appreciation of calligraphy of Arabic and Persian languages
- Developing understanding of History of languages and classical literature

Programme of Study: (Courses run by the Department/Centre)

S.No	Program of Study	Duration	No. of Seats	Specialization(s)
1.	Ph.D.	5 years (includes course work)	6	Language and Literature
2.	M. A.	4 semester	75 (Arabic)+75 (Persian)	
3.	B. A.	3 years	120 (Arabic) + 120 (Persian)	

Faculty members and their Area of Research

S.No	Name of Faculty	Gender	Designation	Area of Specialization
1.	Dr. Mohd. H. A. R. Mirza	Male	Asst. Professor	Translation
2.	Dr. Neelofer Hafeez	Female	Asst. Professor	Poetry
3.	Dr. Saleha Rasheed	Female	Professor and head	Literature

Support Staff

S.No	Name	Gender	Designation	Work Assigned
1.	Nishi Mohini	Female	Section officer	Office work
2.	Harish Chandra Yadav	Male	Peon	Office work

Details of students, Programme wise and reservation wise (2018-19)

Course	Gen			OBC			SC			ST			Total		
	Male	Female	Total	Male	Female	Total	Male	Female	Total	Male	Female	Total	Male	Female	Total
Ph.D.	-	2	2	4	4	8	-	-	0	-	-	0	4	6	10
PG	33	25	58	22	23	45	-	-	0	-	-	0	55	48	103
UG	61	52	113	35	36	71	-	-	0	-	-	0	96	88	184
Total	94	79	173	61	63	124	0	0	0	0	0	0	155	142	297

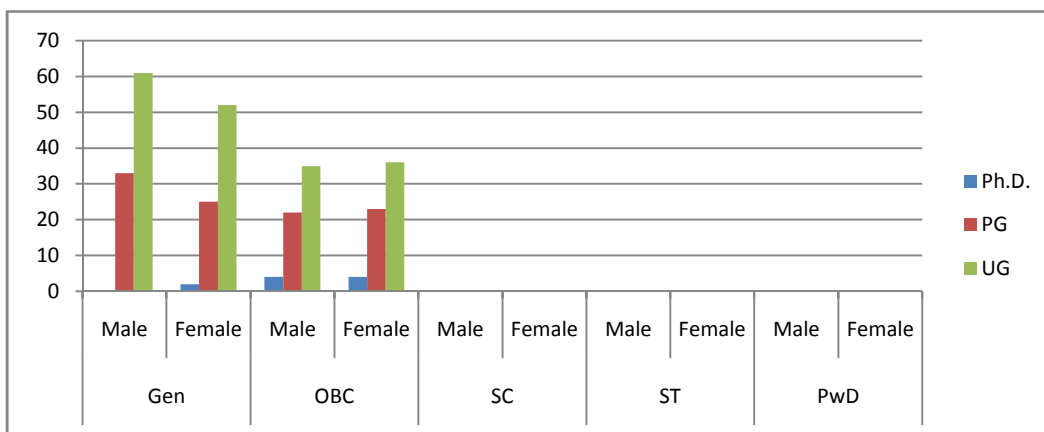

Student Enrollment for the Department

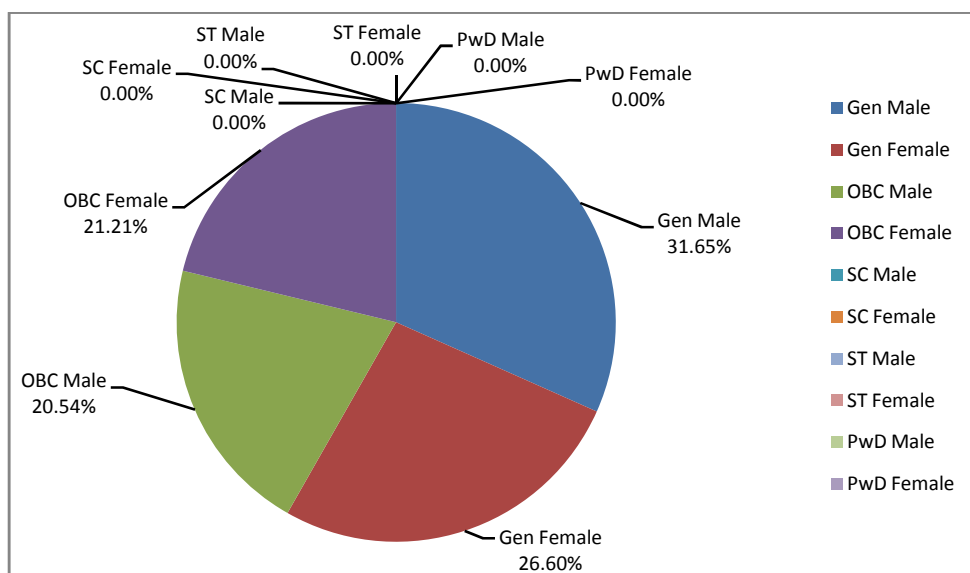

Gender wise distribution of Students

Training/orientation/refresher courses/special lectures conducted by the Department/Centre

S.No	Name of the course	Duration and dates	Speakers
1.	Islamic Art and Architecture	09.07.2018	Mr. Khwaja Ghulam us Saiyedain
2.	Career Prospects in Arabic and Persian	08.08.2018	Mr. Shamshad Ahmad
3.	International Job Opportunities for Arabic and Persian students	13.11.2018	Mr. Shamshad Ahmad

Awards/ Honours/ Fellowship received

S.N.	Name of faculty Members/ Student who received award	Name of the award	Organization conferring award
1.	Prof.Saleha Rasheed	Sir Tej Bahadur Sapru Award	Anjuman Roohe Adab & Rising India
2.	Prof.Saleha Rasheed	Muslim Mahila Samman	AlHasna Society

Outreach activities

S.No	Name of Faculty Member/ Student/ Researcher	Title of the paper presentation	Title of Conference/ Seminar	Duration of the Conference / Assignment	Organized by
1.	Prof. Saleha Rasheed	Bachchae Mardum o Laindra ka Tajziyati Mutalea	4 Day International Seminar (Urdu, Hindi, English)	7 – 10 Dec 2018	Urdu Dept., CCSU Meerut
	Prof. Saleha Rasheed		Training Programme on Academic Leadership	24-27 Apr 2018	Centre of Academic Leadership & Education Mgmt., AMU
	Prof. Saleha Rasheed		Workshop for Manuscripts and Projects	3-5 July 2018	NCPUL, MHRD, India
	Prof. Saleha Rasheed	Quran aur Fanne Khattati	Calligraphy Workshop	31 Oct – 10 Nov 2018	Allahabad Museum
	Prof. Saleha Rasheed	Story recitation	Literary Fest	13-14 Dec 2018	Allahabad Museum
2.	All Staff and faculty		International Arabic Language Day	18-19 Dec 2018	Dept. of Arabic & Persian, AU
3.	Dr. Mahmood Mirza	“Reality of Arabic Language in the light of “Rehlat-alQustanditayah, wa Misr Wash Sham” by Shiekh Shibli Nomani”, MajalaturTilmiz, ISSN 2394 -6628 Vol.01 Issue 04,		April 2018.	Higher Education Department, Government of Jammu and Kashmir. PP 81-
	Dr. Mahmood Mirza	“Ummahatul Moamineen’s method of Preaching during Prophet’s period”, (1st Part) Al -Baas –el- Islami,		May, 2018.	Lucknow,
	Dr. Mahmood Mirza	“Ummahatul Moamineen’s method of Preaching during Prophet’s period”, (2nd Part) Al - Baas –el- Islami,		June, 2018.	Lucknow,
4.	Dr. Neelofar Hafeez	Mahatma Gandhi ka Tasawwur-e-Aman-o-Aashti, Page No. 26-28		October 2018	Urdu Duniya, Vol. 20, Issue: 10,
	Dr. Neelofar Hafeez	,Allama Shibli ki Farsi Ghazal Sarai, Vol. 5, Issue: 4, Page No. 15-21		October-December 2018	Dabeer, Quarterly Refereed Journal,
	Dr. Neelofar Hafeez	Rubaika Fan aur Saeed Sarmadki Rubai Goi, Page No. 98-113		January-March 2019	Fikr-o-Tahqeeq, Quarterly, New Delhi
	Dr. Neelofar Hafeez	Rawish-e-Intiqad-e-Adabi Dar Tazkara-e-Tauhf-e-Saami, Page No. 196-201,		November 2018	Vishva-Bharti University, Shantiniketan

Other information (about the department)

- Book Release Function held on 27.09.2018, to release two books, viz., “Al-Waseelah” & “Aahang”, authored by students of the department
- Visit of Prof. Ehsanullah Shokrollahi of Bonyade Saadi, Iran, Presently Director, Persian Research Centre, Iran Culture House, New Delhi, held on 20.09.2018
- World Arabic Language Day activities celebrated annually
- Book Release function held on 26.01.2019, in Senate Hall, during Republic day celebrations, for book titled “Bostan-e-Khayal”, authored by Prof. Saleha Rasheed
- Dr. Firoz Akhtar placed as Lecturer in Rampur Govt. College through UPPSC in 2018.
- Many MNCs like Genpact and ATL recently approached the Department to hire translators and interpreters in Jan 2019.



DEPARTMENT OF EDUCATION

Introduction:

Department of Education, University of Allahabad works with the objective of developing the academic and cultural talent of the students, improving their professional competencies to work as a team, and raising their level of confidence as would be Teachers and Teacher Educators. Department strives for developing a cohesive work culture amongst the faculty members. Department got upgraded to DRS-II from DSRS-I by UGC SAP for a period of five years 2018 to 2023 in the thrust area of quality improvement in research in Education, Teachers and teacher Educators with P.K. Sahoo as Co-coordinator and Prof. D. Yadav as Dy. Co-coordinator. The UGC has sanctioned one project fellow and Rs. 52.50 Lakh for such project.

Special Initiatives

- The Department is in the process of collaborating with MGN Institute of Rural education, Hyderabad in the implementation of Naitaalim initiative for Teacher education programs.
- The Department participated in developing norms for Accreditation of Teacher education Institutions with NCTE, New Delhi.
- Implementation of CBCS rules in B.Ed. Two Year program.

Thrust Areas:

- The Department promotes discipline based programs in Education as well as Professional Education programs at UG and PG level. The new curriculum has been implemented and executed successfully in M.Ed. and M.A. level at Department of Education, and B.Ed. courses running in the constituent colleges of Allahabad University since 2015-16. Major thrust areas are as follows-
 - i. Quality issues in Education.
 - ii. Development of research potential among young scholars .
 - iii. Professional competencies among teacher educators.
- Department provides digital learning facilities.
- Annual researchers meet was held to review the progress made by the researchers in their respective areas.
- Formation of P.G. Association is one of the annual events of post graduate students of the Department of Education in which students elected Secretary, Joint secretary, Asst. Secretary, Class representatives and in charges for cultural activities and maintenance of the discipline of the department under the supervision of teachers.
- One Day Disaster management workshop was organized in the Department in which Faculty and students were trained.

Programmes of Study:

S.No.	Programme of Study	Duration	No. of Seats	Specialization(s)
1.	Ph.D.	5 years (includes course work)	43 enrolled	Philosophy of Education, Sociology of Education, Educational Psychology, Educational Administration, Educational Technology, ODL system and Teacher Education
2.	M. A.	2 years	31	Educational Administration and Management, Educational Technology, Inclusive Education
3.	M.Ed.	2 years	50	Educational Administration and Management, Educational Technology and ICT, Inclusive Education, Guidance and Counseling

Faculty members and their Area of Research:

S.N.	Name of Faculty	Designation	Area of Specialization
1.	Dr. Akanksha Singh	Assistant Professor	Special Education, Educational Administration
2.	Dr. Dhananjai Yadav	Professor & Head	Educational Technology, Measurement & Evaluation
3.	Dr. K. S. Misra	Professor	Educational Psychology, Guidance & Counseling, Research & Statistics

S.N.	Name of Faculty	Designation	Area of Specialization
4.	Dr. P. K. Sahoo	Professor	Education Technology, Research Methods, Teacher Education
5.	Dr. PrashantAstalin	Assistant Professor	Curriculum Studies, Measurement& Evaluation
6.	Dr. RuchiDubay	Assistant Professor	Educational Psychology, Guidance & Counseling
7.	Dr. SarojYadav	Assistant Professor	Educational Technology, Measurement& Evaluation
8.	Dr. Usha Mishra	Professor	Sociology of Education, Curriculum Development, Measurement & Evaluation

Support Staff:

S.N.	Name	Gender	Category	Designation	Work assigned
1.	Mr. Sanjeev kr. Singh	Male	Gen	Office Assistant	Office work
2.	Ram lakhanyadav	Male	OBC	Office Assistant	Office work
3.	Shobha Devi	Female	Gen	Peon	Office work
4.	Lallan	Male	OBC	Peon	Office work

Details of Students, Year wise and Reservation wise (2018-2019):

Course	Gen			OBC			SC			ST			PwD			TOTAL		
	Male	Female	Total	Male	Female	Total	Male	Female	Total	Male	Female	Total	Male	Female	Total	Male	Female	Total
Ph.D.	3	14	17	6	9	15	5	4	9	0	2	2	1	0	1	15	29	44
PG	20	21	42	31	25	56	14	21	35	0	1	1	4	2	6	68	68	136
UG	264	96	360	503	85	588	190	95	285	24	14	38	0	0	0	981	290	1271
Total	288	131	419	540	119	659	209	120	329	24	17	41	5	2	7	1064	387	1451

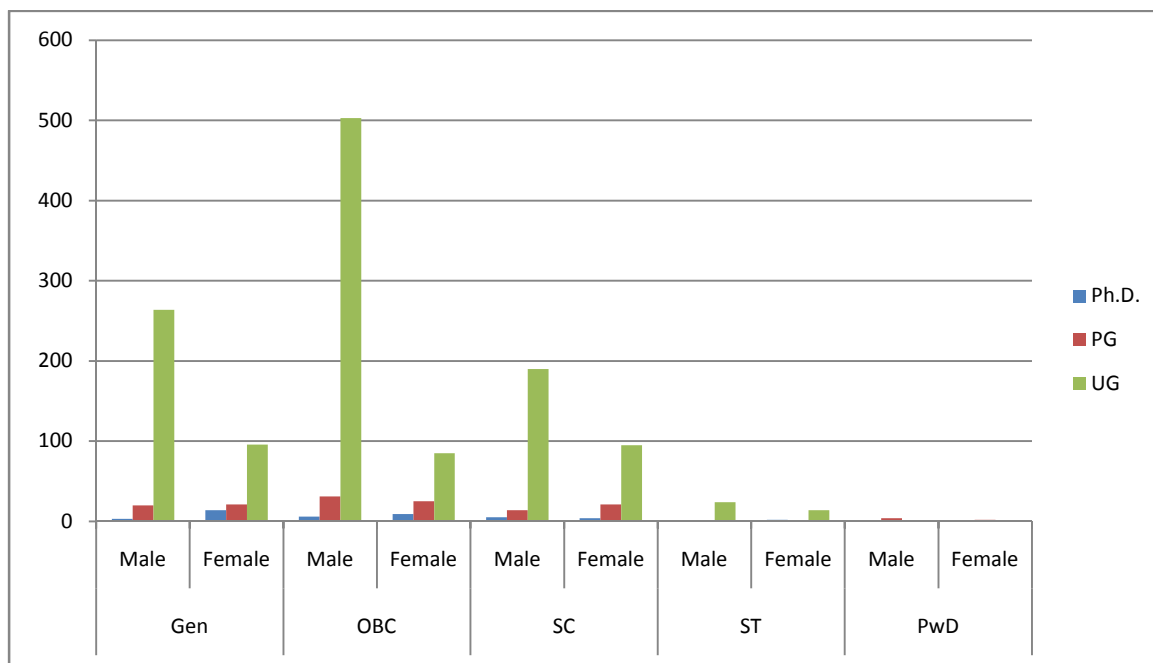

Student Enrollment for the Department

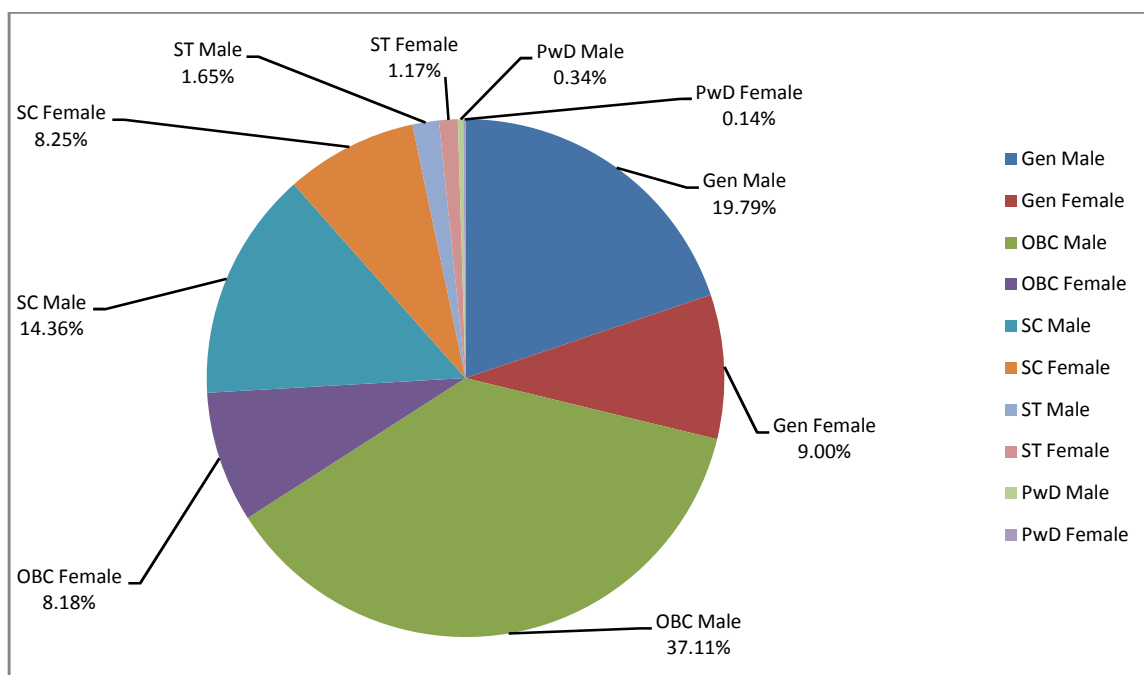

Gender wise distribution of Students

Training/orientation/refresher courses/special lectures conducted by the Department:

S. No.	Name of the course	Duration and dates	Funding/ sponsor	Speakers
1.	Refresher course for Teacher Educators	21-02-2019 - 13-3-2019	UGC, HRDC	<ul style="list-style-type: none"> • Prof. Ramchandran, Advisor Indo-African Institute of Educational Planning and Administration, NIEPA, New Delhi • Prof. Ram Pal Vadera, Pro-Vice chancellor, Mizoram Central University, Aizwyal • Prof. H.N.Mishra, ICSSR, Senior fellow, University of Allahabad. • Prof. Vidyaagrawal, Retd. Prof. Allahabad University • Prof. Ashishsaxena, Head of Department, Sociology, UoA • Prof. S.P. Gupta, Former Head, School of Edu., UPRTOU, Alld. • Dr. Sujeet Kumar Mishra, GGD Unuiversity,, Bilaspur • Prof. U.C.Vashishta, Former Dean, Faculty of Education, LU • Prof. S.N.Mishra, Retd. Prof. Utkal University, Bhubaneshwar • Prof. P.K.Ghosh, Department of Economics, Allahabad University • Prof. SujataRaghuvansh, Retd. Professor, Allahabad University • Dr. B.K.Singh, Librarian Allahabad University • Prof. S.K.Tyagi, Former Director, IOE, ICSSR, Senior Fellow, DAVV Indore. • Prof. D.R. Goel, UG Emeratus Professor, MSUniversity, Baroda. • Prof. Chhaya Goel, Retd. Professor, MS University, Baroda. • Prof. A. Muthumanickam, Director, School of Education, M.K. University, Madurai, • Prof. D. R.singh, Retd. Prof. Allahabad University • Prof. D.Yadav, HOD, Education, Allahabad University • Prof. Usha Mishra, Allahabad University

Awards/Honours/Fellowship received/nomination in national Bodies-

S.No.	Name of Faculty Member/ Student who received award	Name of the award	Organization conferring award
1.	Prof. DhananjaiYadav	Member, Standing Committee for Academics of NCTE, New Delhi, for a Period of four years.	NCTE, New Delhi

Funding received during the

S.No.	Agency	Purpose	Amount
1.	UGC-SAP DRS-II	Up gradation of IT resources, conference , seminar, training	52.50 lakhs

Journals published by the Department/Centre:

S. No.	Title	Nature	Established	Annual/bi-annual /quarterly	ISSN
1.	Researches and Studies	National		Annual	0084-621

Other publications by the Department/Centre

S. No.	Title	Type	Author(s)
1.	Newsletter of UGC, SAP	Yearly	Coordinator SAP

Outreach activities:

S.N.	Name of Faculty Member/ Student/ Researcher	Title of the paper presented	Title of Conference/ Seminar etc	Date of the conference/ assignment	Organized by
1.	Prof. Dhananjai Yadav	Making Class room Teaching Effective by Using ICT	Refresher Course	2018-19	UGC HRDC, UoA
		Microteaching Techniques	Orientation course	2018-19	UGC HRDC, UoA
		Issues of Measurement and Evaluation in Higher Education	Winter School Programme	2018-19	UGC HRDC, UoA
		Teachers Educators on Examination Reforms in Higher Education	Refresher Course	March, 2019.	UGC HRDC, UoA
		Issues of Research in Education	Short term course	January,2019	Faculty Development Centre of ISDC, Allahabad
		Presented Key Note Address on Evaluation In Higher Education in 21 st Century	ICSSR Sponsored National Seminar	14 th Feb, 2019	ISPG College, Allahabad.
		Chaired one Technical Session on Problems and Prospect of Teacher Education at Elementary Level	52 nd IATE National Conference on Indian Teacher Education At Crossroads: Whitherto	15 th Feb, 2019.	MJP Rohilkhand University, Bareilly
2.	Prof. P. K. Sahoo	Education for Development of Human Values	National Seminar "Value-Added Education in Present Era".	10 & 11 February 2018.	Shree Balaji Academy, Sambhal Road, Moradabad at Rohilkhand University, Bareilly.
		Research Designs	Invited Lecture	28 th Mrach,2018	Ravenshaw University, Cuttack, Odisha
		"Review of Research" and Research Design"	National Colloquium on Mechanics of Thesis writing	18-19, April 2018.	Tamil Nadu Teacher Education University, chennai.
		Student Teachers perception towards Restructuring of Teacher Education in Odisha	IATE National Seminar on Paradigm shift in Teacher Education	May 26,2018.	Khalsa College of Education,Amritsar
		Decision Making Level of Students and Teacher Educators	32 nd AAOU Annual Conference	24-26, October, 2018	Hanoi Open University, Vietnam.
		"Quality Concerns and Qulity Parameters in Social Research and Ethical Consideration in Social Science Research	Invited Lecture	02 nd November, 2018	Department of Education,Mahatma Gandhi KashiVidyapithVaranasi,U.P.
		Sri SathyaSai Models of Education for Human Values	International Conferences on Universal Religion and Education (ICURE-2018)	18 November, 2018	Faculty of Education, BHU. Varanasi

UNIVERSITY OF ALLAHABAD

S.N.	Name of Faculty Member/ Student/ Researcher	Title of the paper presented	Title of Conference/ Seminar etc	Date of the conference/ assignment	Organized by
		Sri SathyaSai Education for Harmony	International Conference on Education	2nd -3 rd December,2018	School of Education, Dr. Babsaheb Ambedkar Open University
		Paradigms of Educational Research	Invited Lecture	3rd December 2018	Education Department Gujarat Vidya Peeth, Ahmedabad.
		Evaluation Research	Invited Lecture	10-12-2018	Department of Education, Punjab University, Chandigarh.
		Education for Sustainable Development of Tribes in India	International Symposiu Open Pages in South Asian Studies .	22-23 Jan, 2019	Department of Foreign Languages, Gauhati University.
		'Parameter of Teaching Effectiveness'	Invited Lecture	01 February, 2019	College of Education, Guru Kashi University, Talwandi Sabo, Bathinda, Punjab.
		"Mixed Method Research	Invited Lecture	04.02.2019	Education Department Guru Nanak Dev University, Amritsar.
		Qualitative and Qualitative Research	Invited Lecture	04.02.2019	Khalsa College of Education Ranjeet Avenue Amritsar
3.	Prof. P. K.Sahoo	Curriculum Research, Policy and Educational Development,	Resource Person in the workshop	16 July -25 July 2018	School of Education Central University of Punjab Bathinda.
		Examination Reforms for Quality Higher Education in India	Delivered Valedictory address	22-23 December, 2018	School of Education, Ravenshaw University, Cuttack.
		Policy and Educational Development	Acted as Resource person	workshop organized by Centre for Curriculum Research,	School of Education from 28 th January-06 th February 2019 at Central University of Punjab Bathinda.
		ICSSR Seminar held	Acted as Resource person		15 Feb -2019 organized by Ishwar Sharan Degree College.
		Act as Resource Person in the Acted as Resource person IATE conference	Acted as resource person	15-17, Feb.2019.	MJPR University Bareilly
		Trends and Innovation in Teacher Education in India	National Seminar	16-17 March,2019	Department of Education, DeenDayal Upadhyay University, Gorakhpur
4.	Dr.RuchiDubay	RPWD Act 2016- Issues & Challenges in implementation,	National Conference	19.1.2019	UPRTOU.PrayagRaj
		Presented paper entitled- Evaluation in Higher Education in 21 st Century,	National seminar	14-15 February 2019	ISDC, Allahabad.
		Emotional Intelligence and Mental Development during childhood and adolescence	Invited lecture	23.2.19	Jagpat Singh Singraur P. G. College, Allahabad
5.	Dr. Akanksha Singh	Educational administration	Invited Lectures	July ,2018	SIEMAT(State Institute of Educational Management and Training)
	Dr. Akanksha Singh	Vichar-Kumbh	National Symposia	Feb.1, 2019	S.S.Khanna Girls' Degree College, Allahabad.
6.	Dr. SarojYadav	Relevance of Rights of persons with disability act	National Conference on RPWD Act 2016- Issues& Challenges in implementation	Jan, 19, 2019	UPRTOU. PrayagRaj
		Applications of ICT in teaching learning process	Invited Lecture	Jan, 29, 2019	GIS College, Saugar
		Regional Eco-Development of Ganga Plan,	National Seminar (BhoogolKumbh)	16-17 Feb. 2019.	I.R.E.D and UPRTOU, Prayagraj.

UNIVERSITY OF ALLAHABAD

S.N.	Name of Faculty Member/ Student/ Researcher	Title of the paper presented	Title of Conference/ Seminar etc	Date of the conference/ assignment	Organized by
		Equality of Educational opportunities and caste system in India	International Conference on Social Justice and Development	23-24 Feb. 2019	DDU Government PG College, Prayagraj
		Bhartiyasanskriti k maanviyaswaroop me shikshakibhoomika	National seminar	6-7 dec. 2018	UPRTOU, Prayagraj
		Bharat kendritAdhyapakshikshakiawashya kata	National Seminar on Bharat Kendritshikshaevamuskipratis thapna me shikshakkiBhoomika	17-18 jan 2018	Sohagi College of Education, Rewea
7.	Dr. P.K.Astalin	Bharat me JatigatSamasyayenevmJyotibaPhul ekeShaikshanilVichar. organized by	National Seminar on 'Problems of Caste in India: Investigating History and Histogramy'	29 th & 30 th November 2018.	Dept. of Med. and Mod. History, UoA
8.	Dr. P.K.Astalin	New Approaches of e-learning in Higher Education, Assessment and Evaluation of e-learning'.	National Seminar on 'Evaluation in Higher Education in 21 st Century'	14-15 February, 2019.	Dept. of Education, Iswar Saran PG College, Prayagraj
		Social Justice, Development and Indian Constitution'.	International Seminar on Social Justice and Development: Challenges and Opportunities in Vibrant Democracies	23 rd and 24 th February, 2019.	Department of Political Science, DDU Govt. PG College Saidabad, Prayagraj



Interaction with Member Secretary, NCTE, New Delhi



Valedictory session of Refresher course for Teacher Educators

DEPARTMENT OF ENGLISH AND MODERN EUROPEAN LANGUAGES

Introduction

The Department of English and Modern European languages, University of Allahabad, has a unique distinction of being one of the oldest English Departments in the country. Established in 1922, it was part of the British plan of westernizing the natives of the land through education, “the white man’s burden”. As part of that colonial legacy, we still have the S.G Dunn (our first British Head of the Department) memorial gold medal for the undergraduate topper in English. This historical truth and inheritance always gave the Department an elitist character. We have had our share of brown sahibs walking the portals of the grand Edwardian Mughal structure (with Rajasthani artefacts) that houses us till date. There were great teachers in this Department who in their own style carried the mantles of Oxford dons that they reflected in the then “Oxford of the East” of which the English Department could be called the truest representative.

Thrust Areas:

- British Literature
- American Literature
- Indian Literature
- Language and Linguistics
- Gender Studies
- Environment and Literature

Programmes of Study:

S. No.	Programme of Study	Duration	No. of Seats
1.	Ph.D.	5 years(includes course work)	As per vacancy
2.	M. A. English	4 Semesters (2 years)	262
3.	B.A. English Language & English Literature	3 Years	798
4.	Diploma Courses	French, Russian, German	2 years
5.	Any Other (Certificate Courses)	French, Russian, German	1 Year

Faculty members and their Area of Research:

S.N.	Name of Faculty	Gender	Category	Designation	Area of Specialization
1.	Bandana Sharma	Female	GEN	Professor	Shakespeare, Children’s Literature, British Literature
2.	Bhaskara Jha	Male	GEN	Associate Professor	German Language and Literature
3.	Deepika Srivastava	Female	GEN	Professor	Victorian British Literature , Indian Fiction Studies
4.	Gunjan Sushil	Female	GEN	Professor	Indian Literature, Modern British Literature, D H Lawrence
5.	Indrani Mukharjee	Female	GEN	Professor	Tagore, Shakespeare, Contemporary Literature
6.	Jaya Kapoor	Female	GEN	Assistant Professor	Theatre Studies Partition Studies and Cultural Studies
7.	Lakshmi Raj Sharma	Male	GEN	Professor	Literary Theories, Shakespeare and Creative Writing
8.	Neelum Saran Gour	Female	GEN	Professor	Contemporary Literature, Creative Writing
9.	Phool Chandra Singh	Male	GEN	Professor	Folklore and Comparative Study
10.	Rakesh Kumar Singh	Male	GEN	Professor	American Fiction, Cultural Studies
11.	Raju Parghi	Male	ST	Assistant Professor	African American and Indian Women’s Drama, Postcolonial Studies and Nature Studies

S.N.	Name of Faculty	Gender	Category	Designation	Area of Specialization
12.	Sanjoy Saksena	Male	GEN	Professor	Postcolonial Studies
13.	Sarvajit Mukerji	Male	GEN	Professor	Environmental Studies, Women's Studies
14.	Smita Agarwal	Female	GEN	Professor	Modern Poetry and Women's Studies, Culture Studies, Creative Writing
15.	Sonjoy Dutta Roy	Male	GEN	Professor	Contemporary Poetry, Performance Studies, Culture Studies, Narrative Studies Creative Writing
16.	Susheel Kumar Sharma	Male	GEN	Professor	English Studies in India, John Milton, Language and Linguistics
17.	Sushmita Roy	Female	GEN	Professor	British Poetry

Support Staff:

S.N.	Name	Gender	Category	Designation
1.	Smt. Malti Devi	F	OBC	Office Asstt.
2.	Sri. Krishna Murari	M	OBC	Jr. office Asstt.
3.	Sri. Ram Sajeevam	M	OBC	Peon
4.	Sri. Rajesh Kumar	M	OBC	Peon
5.	Sri. Kasim	M	OBC	Peon
6.	Sri. Ajay Kumar Khatri	M	Gen	MTS

Details of Students, Programme wise and Reservation wise (2018-2019):

Course	Gen			OBC			SC			ST			PwD			TOTAL		
	Male	Female	Total	Male	Female	Total	Male	Female	Total	Male	Female	Total	Male	Female	Total	Male	Female	Total
Ph.D.	30	20	50	13	20	33	5	5	10	0	1	1	-	-	-	47	45	92
PG	38	48	86	56	30	86	36	13	49	1	0	1	12	7	19	135	105	240
UG	404	176	580	641	160	801	234	103	337	24	3	27	-	-	-	1303	442	1745
Diploma	88	49	137	69	26	95	23	8	31	7	1	-	-	-	-	187	84	271
Total	560	293	853	779	236	1015	298	129	427	32	5	29	12	7	19	1672	676	2348

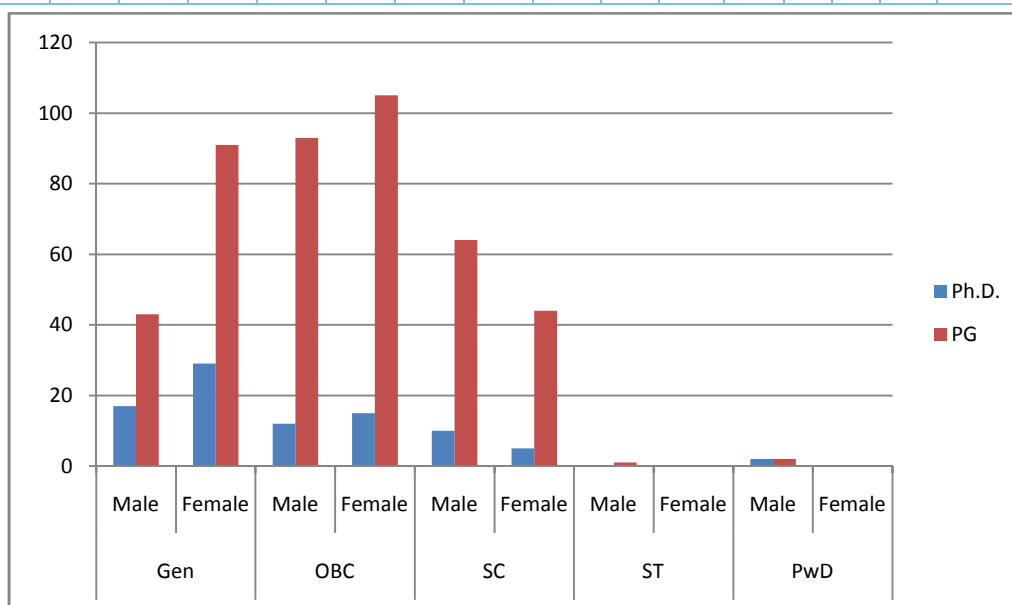

Student Enrollment for the Department

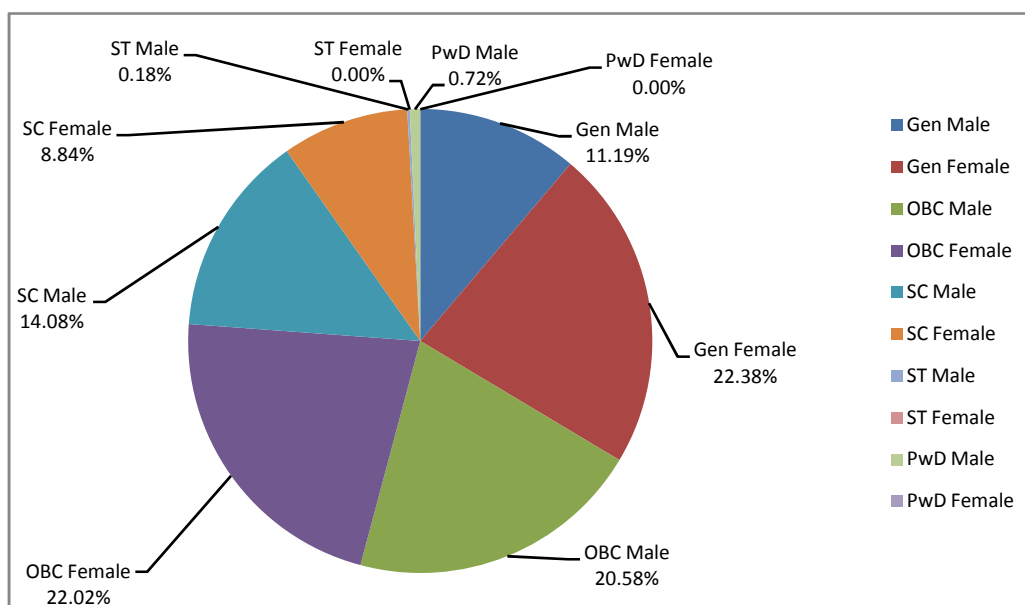

Gender wise distribution of Students

Training/orientation/refresher courses/special lectures conducted by the Department/Centre:

S.N.	Name of the course	Duration and dates	Funding/ sponsor	Speakers
1.	Refresher Course in English	21 days From 4 th December 2018 to 24 th December 2018	UGC-HRDC.	Prof. MM Das, Prof R P Singh Prof Ghoshal, Prof Cheedananda etc.

Awards/Honours/Fellowship received:

S.N.	Name of Faculty Member/ Student who received award	Name of the award	Organization conferring award
1.	Dr. L R Sharma	Award of Excellence	University of Allahabad
2.	Dr. N S Gour	Award of Excellence	University of Allahabad
3.	Dr. N S Gour	The Hindu Fiction Writer Award	The Hindu
4.	Dr. Smita Agarwal	Award of Excellence	University of Allahabad
5.	Ms Tooba Masood	PG Gold Medal	University of Allahabad

Proposed Courses

S. No.	Name of Programme	Nature	Proposed or In process	Intake of Students
1.	M A English Language	Degree	In discussion	50
2.	B A Russian, French and German	Degree	In discussion	16 students each subject

Academic Profile 2018-19

Prof. Smita Agarwal

- Courses Organized: 3 months Certificate Course, “Understanding Gender”, July 2018 – Nov. 2018, in Centre for Women’s Studies, University of Allahabad.
- M.A. in Women’s Studies initiated from August 2018. Two Semesters completed till April 2019.
- Project : Principal Investigator in Project Conducted and Published by Centre for Women’s Studies, Univ. of Allahabad. 2018. Funding Agency UGC. Central Govt. Project “The Effect of Demonetization on Women working in the Unorganized Sector”.
- Workshop Organized: One day workshop on Gender, Sexuality and Mental Health in the Centre for Women’s Studies on 11 June, 2018
- Special Lectures Organized: (i) In the Centre for Women’s Studies, A.U., Harish Kumar Yadav on “Women and War” on 6th Sept. 2018. (ii) In the Centre for Women’s Studies, A.U., Prof. L.R. Sharma on Chimamanda Ngozi Adichie on 1st Nov. 2018.

- Special Lectures Delivered: Androgyny in Mahesh Dattani's *Tara* in Hamidia Girls Degree College, Allahabad, March 2018.
- Special Review Lecture on Understanding Gender in Centre for Women's Studies, A.U. on 31st October, 2018.
- Globalization and Gender, in Centre for Women's Studies, A.U. on 28th Nov. 2018.
- Narrating the Nation: Indian English Women Poets in the Academic Staff College, University of Allahabad, Refresher Course in English on 11 Jan. 2019.
- Changes glimpsed in Asian women over the past Decade in a Colloquium organized by Kapila Vatsyayan under the Asia Research Project of the India International Centre, New Delhi, on 2nd March, 2019.
- Women-centric Poems read in Hamidia Girls' Degree College, A.U. on 7th March 2019.
- Women's Emancipation: Issues and Challenges. Keynote Address, in a Symposium in Ewing Christian College, A.U. on 8th March, 2019.

Prof Indrani Mukharjee:

- Project titled "Depiction of Child Psychology in Contemporary Novels: A Cultural Overview [with special reference to Toni Morrison, Beverley Naidoo, J. K. Rowling, Khaled Hosseini & Arundhati Roy]" submitted as Report for six months sabbatical leave. (April 2018).
- Ph.D. awarded to Sarita Dubey on "Ecofeminism and Quest for Identity in the Novels of Anita Desai, Arundhati Roy, Kiran Desai and Shashi Deshpande" (December 2018).
- Lecture delivered in UGC sponsored Refresher Course on "Philosophical Narrative in Tagore's Plays" conducted by Department of English, University of Allahabad (December 2018).
- Attended National Seminar on "Literature, Power, Culture & Society: Interconnections & Divergences" (April 2019).

Prof S K Sharma

- Sharma, Susheel Kumar is a member of the editorial board of *The Journal of Indian Thought and Policy Research* (Allahabad), *Transcript* (Bodoland University, Kokrajhar) and *Modern Research Studies: An International Journal of Humanities and Social Sciences* (Agartala), a member, Editorial Board, *East European Journal of Psycholinguistics* (Lesya Ukrainka Eastern European National University, Ukraine)
- Sharma, Susheel Kumar, Member, Board of Studies in English, University of Allahabad, Allahabad, UPRTOU, Allahabad, CSJM University, Kanpur, Mizoram Central University, Aizwal
- Sharma, Susheel Kumar, Member, Research Degree Committee, CSJM University, Kanpur
- Sharma, Susheel Kumar helped various Universities/ Institutions and Commissions like Kurukshetra University, Kurukshetra, Union Public Service Commission, New Delhi, Uttarakhand Public Service Commission, Haridwar, Uttar Pradesh Public Service Commission, Allahabad and UP Higher Education Commission, Prayagraj in selecting candidates in the respective places for different jobs/ positions.
- Sharma, Susheel Kumar evaluated several Ph D theses of the following universities: Barkatullah University, Bhopal, Berhampur University, Berhampur, CCS University, Meerut, Dr H S Gour University, Sagar, CSJM Univ, Kanpur, Kerala University, Trivandrum, GND University, Amritsar. Some of these places were also visited to conduct viva-voce.

Lectures/ Seminars:

- Presented a paper on "English Studies in India: Retrospect and Prospect", National Conference on 'Rethinking English Studies in India: 1960-2018' organised by 'The Researchers' Association', Cuttack, Odisha, 16 - 17 June, 2018.
- Presented a paper on "A Peep into Ambedkar's *Partition of India*", National Seminar (sponsored by ICPR) on 'Dr B R Ambedkar – Thinker for All Ages' organised by Bhartiya Vidya Bhawan's Sheth R A College of Arts & Commerce, Khanpur, Ahmedabad and GOPIO, 23-24 November, 2018.
- Presented a paper on "Recreated Characters of the Mahabharata—A Study of Drona", National Seminar (sponsored by ICHR) on 'Role of Cultural History in Formation of Society' organised by Bhartiya Vidya Bhawan's Sheth R A College of Arts & Commerce, Khanpur, Ahmedabad and GOPIO, 24 – 25 November, 2018.
- Presented a paper as a plenary speaker on "Post-truth: An Enquiry through Sat, Satya and Sahitya", Debating the Post-truth Phenomenon: Literature, Culture and Critical Discourse, DAV Post Graduate College, Banaras Hindu University, Varanasi, 19-20 December 2018.
- Presented a paper as a Keynote speaker on "Popular Culture, Literature and Cyberspace: Some Reflections", UGC Sponsored National Seminar on "Popular Culture, Literature and Other Art Forms: Today and Beyond", Department of English, Indira Kala Sangit Vishwavidyalaya, Khairagarh, 18-19 January 2019.
- Chaired two sessions in National Conference on 'Rethinking English Studies in India: 1960-2018' organised by 'The Researchers' Association', Cuttack, Odisha, 16 - 17 June, 2018.
- Delivered two invited lectures on "Gandhi and Krishnamurti on Education: Looking for Alternatives", 120th Orientation Course for University and College Teachers, UGC- Human Resource Development Centre, University of Allahabad, Allahabad, July 26, 2018.
- Delivered two invited lectures on "Writing Research Papers", 120th Orientation Course for University and College Teachers, UGC- Human Resource Development Centre, University of Allahabad, Allahabad, July 30, 2018.
- Delivered two invited lectures on "Educational Vision of Swami Vivekananda", Orientation Course for University and College Teachers, UGC- Human Resource Development Centre, University of Allahabad, Allahabad, Sept 22, 2018 (10-1 pm).
- Delivered two invited lectures on "Integral Humanism and Culture", Interdisciplinary Refresher Course on "Culture Studies" for University and College Teachers (17 Sept to 07 Oct 2018), UGC- Human Resource Development Centre, Dr H S Gour University, Sagar, 24 Sept 2018.
- Delivered two invited lectures on "Indian Culture and Swami Vivekananda", Interdisciplinary Refresher Course on "Culture Studies" for University and College Teachers (17 Sept to 07 Oct 2018), UGC- Human Resource Development Centre, Dr H S Gour University, Sagar, 24 Sept 2018.

- Delivered an invited lecture on “Adversity of Education System in India: An Alternative”, Symposium on Emerging Development Discourses: A Critique, Department of Sociology, University of Allahabad, Allahabad, 26 October 2018.
- Delivered two invited lectures on “Literary Representations of Dronacharya”, Refresher Course on “Narratives: Poetic, Performative” for University and College Teachers (04.12.2018 to 24.12.2018), UGC- Human Resource Development Centre, Department of English & MEL, University of Allahabad, Prayagraj, 6 December 2018.
- Delivered a talk on “Indian Poetry Scene in English”, First Haridwar Literary Festival organised by Gurukul Kangri University, Haridwar and Antah Pravah Society Haridwar, 14 – 16 December, 2018.
- Chaired 8th session, LH-2, First Haridwar Literary Festival organised by Gurukul Kangri University, Haridwar and Antah Pravah Society Haridwar, 14 – 16 December, 2018.
- Interviewed Maria Wirth and Mona Verma, First Haridwar Literary Festival organised by Gurukul Kangri University, Haridwar and Antah Pravah Society Haridwar, 14 – 16 December, 2018.
- Delivered one invited lecture on “Gender (In)equality in Cyber Space: Fact & Fiction”, 16th Refresher Course in “Women and Gender Sensitization Studies [Interdisciplinary]” for University and College Teachers (December 18, 2018 to January 07, 2019), UGC- Human Resource Development Centre, Banaras Hindu University, Varanasi, 21.12.2018.
- Delivered two invited lectures on “Forming a Hypothesis in a Research Project”, 122th Orientation Course for University and College Teachers (04.1.2019 to 31.1.2019), UGC- Human Resource Development Centre, Department of English & MEL, University of Allahabad, Prayagraj, 7 January 2019.
- Chaired two lecture sessions (Dr Ramji Jadav’s and Prof NDR Chandra’s) in the UGC Sponsored National Seminar on “Popular Culture, Literature and Other Art Forms: Today and Beyond”, Department of English, Indira Kala Sangit Vishwavidyalaya, Khairagarh, 18-19 January 2019.
- Delivered two invited lectures on “Framing a Hypothesis and Avoiding Plagiarism in Research”, Training cum Workshop on Research Methodology for Humanities and Social Sciences for University and College Teachers (January 07 to January 22, 2019), Faculty Development Centre (under the scheme of PMMMNMTT, MHRD, Govt. of India) Ishwar Sharan PG College, Prayagraj, 21.01.2019.
- Delivered two invited lectures on “What to Publish, How to Publish and Where to Publish”, 122th Orientation Course for University and College Teachers (04.1.2019 to 31.1.2019), UGC- Human Resource Development Centre, Department of English & MEL, University of Allahabad, Prayagraj, 27 January 2019.
- Chaired a session on “Rethinking the Global South” in the 2nd International Literary Conference “Rethinking the Global South: Literatures, Cultures and Media”, Challenging Precarity: A Global Network, UK and Shri Ramswaroop Memorial University, Lucknow, 2 - 3 February, 2019.
- Delivered Valedictory Address on “Can the Global South Speak: Culture, Literature and Cyber Space” in the 2nd International Literary Conference “Rethinking the Global South: Literatures, Cultures and Media”, Challenging Precarity: A Global Network, UK and Shri Ramswaroop Memorial University, Lucknow, 3 February, 2019.

Outreach Activities

1. SARVAJIT MUKERJI ‘Feminist Foremothers’ UGC e-pathshala (available on e-pathshala portal, Youtube)
2. ‘Early Feminist Articulations with Special Reference to Allahabad’ Radio talk broadcast by Akashvani
3. ‘Discrimination across Genders’ Symposium on *Gender Discrimination: Issues and Challenges*, S.S.Khanna Degree College, Allahabad
4. ‘Eliot’s Musical Metaphors’, Refresher Course UGC-HRDC, University of Allahabad
5. ‘Rethinking the Global South’ *Second International Literary Conference* Feb 2-3, 2019 Shri Ramswaroop Memorial University, Lucknow.
- Prof P C Singh: Delivered a Lecture in Refresher Course in English on “Historicism of Folk Epics” 23rd December 2018.
- Dr Raju Parghi, participated in Refresher Course in English from 4th December 2018- 24th December 2018.
- Dr Jaya Kapoor, Delivered lecture on “Self in Dialogue with Self” in Refresher Course in English from 4th December 2018- 24th December 2018.
- Dr Jaya Kapoor, Delivered lecture on “Unexplored Voices of Partition” in Refresher Course in English from 4th December 2018- 24th December 2018.
- Dr Jaya Kapoor, Delivered lecture on “Reading Indian Literature” in English department at APS University Rewa, March 2019.
- Dr Jaya Kapoor, Workshop on Language” in English department at APS University Rewa March 2019.
- Prof Sonjoy Dutta Roy: Coordinator of Refresher Course in English from 4th December 2018- 24th December 2018.
- Prof Sonjoy Dutta Roy Delivered a lecture on Narratives in Performance” at Refresher course on 9th December 2018.
- Prof Sonjoy Dutta Roy Delivered a lecture on The Pedagogy of Storytelling from Knowledge to Wisdom” at Refresher course 7th August 2018 at Patna University.

DEPARTMENT OF GEOGRAPHY

Introduction :

Year Established: Undergraduate – 1937
Postgraduate – 1946

Thrust Areas:

- Regional Development Disparities and Planning
- Quality of Life/Welfare Issue
- Environment & Sustainable Development
- Agro-Climatic Regions
- Agro-Industrial Regions
- Voting Pattern & Electoral Behaviour
- Population and Development
- Neo – Tectonic
- Ground Water Exploration
- Disaster Management
- Arid Land Studies
- Application in Remote Sensing & GIS

Programmes of Study:

S.No.	Programme of Study	Duration	No. of Seats	Specialization(s)
1.	Ph.D.	5 years (includes course work)	10	(Degree according to the Art or Science stream of student)
2.	M. A./M. Sc.	Two years (Four semesters) CBCS	115	Degree according to the Art or Science stream of student
3.	B. A./B. Sc.	Three years	476	In combination with two Arts or Science subjects

Faculty members and their Area of Research:

S.No.	Name of Faculty	Designation	Area of Specialization
3.	Dr. A .R. Siddiqui	Professor	Arid Land Ecology, Remote Sensing G.I.S. (Environment), Urban Geography, Agricultural Geography, Population Geography
1.	Dr. Alok Dubey	Professor & Head	Environmental Geomorphology, Remote Sensing & G.I.S., Ground Water Exploration, Climatology & Oceanography
4.	Dr. Anupam Pandey	Professor	Environmental Geography, Geomorphology, Remote Sensing & G.I.S.
5.	Dr. Ashwajeet Chaudhary	Associate Professor	Environmental Geography, Geography of Water Resources, Hazards
2.	Dr. S. S.Ojha	Professor	Geomorphology, Environmental Geography, Climatology & Geomorphology
6.	Dr. Vandana Shukla		Regional Planning, Settlement Geography , Town Planning

Support Staff:

S.No.	Name	Gender	Categ.	Designation	Work assigned
1.	Khedu Ram	Male	OBC	Junior Office Assistant	Maintenance Laboratory Store, Stock Association Library, Computer Typing work etc,
2	Ganga Prasad	Male	GEN	Lab Attendant	Laboratory wok etc.
3.	Dileep Kumar	Male	GEN	Lab Attendant	Assisting in Office Maintenance, Laboratory etc.
4.	Arjun Chauhan	Male	OBC	Peon	Official work as MTS
5.	Rakesh Kumar	Male	OBC	Parichar	Official work as MTS, etc.
6..	Kamlesh	Male	OBC	Mate	Official work as MTS, etc.
7.	Mehtab	Male	Minority	Lab attendant	Official work as MTS, etc.

Details of Students, Programme wise and Reservation wise (2018-2019):

Course	Gen			OBC			SC			ST			TOTAL		
	Male	Female	Total	Male	Female	Total	Male	Female	Total	Male	Female	Total	Male	Female	Total
Ph.D.	0	0	0	0	0	0	0	0	0	0	0	0	0	0	0
PG	83	22	105	51	13	64	21	8	29	9	4	13	166	47	211
UG	574	48	622	309	26	325	138	19	157	15	7	22	1036	100	1136
Total	657	70	727	360	39	389	159	27	186	24	11	35	1202	147	1347

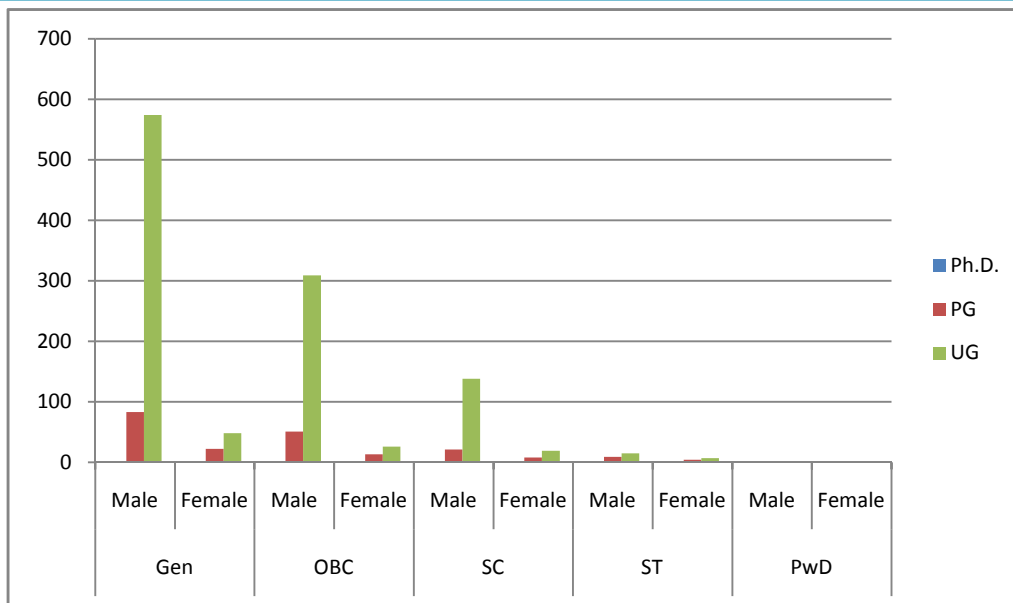

Student Enrollment for the Department

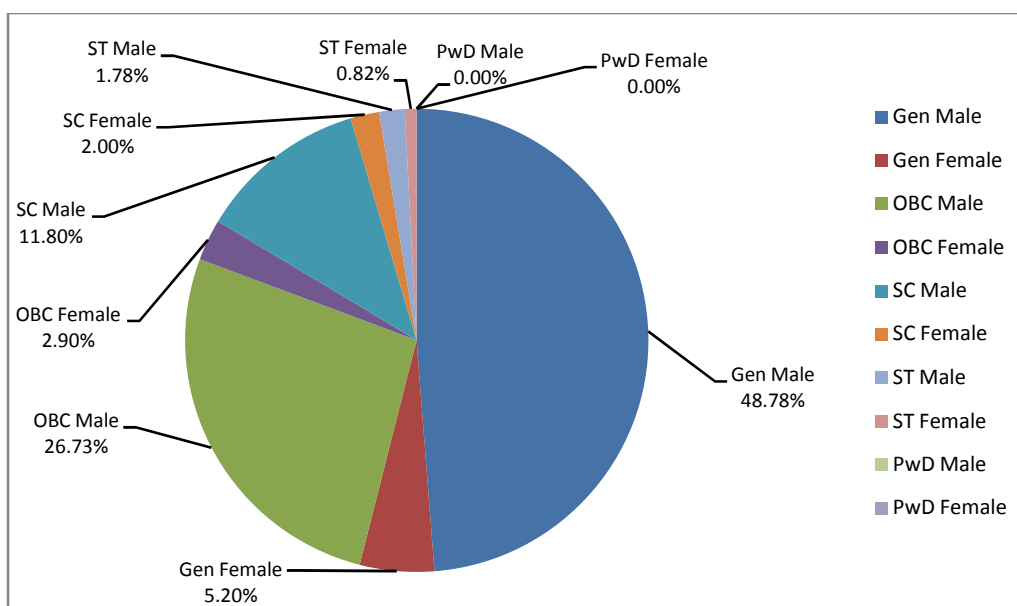

Gender wise distribution of Students

Funding received during the period (amount/purpose/agency) to the Department

S. No.	Agency	Purpose	Amount
1.	Allahabad University Annual Grant	Lab Grant for maintenances	Rs. 1,50,000.00

Student getting post doc fellowships (SRF, RA, DS Kothari and other imp fellowships). Students coming from abroad.

- i. Neda Waheed-Problems and prospects of Drinking Water and Sanitation Condition in slum Areas of Allahabad City by NASI (the National Academy of Sciences, India Rs. 3,25.00Lac) Under the supervision of Prof. A.R.Siddiqui
- ii. Ashutosh Mishra under the supervision of Prof. S.S.Ojha
Topic of the Study:- *Evaluating the Effect of Urban Morphology and Traffic Flow on Microclimatic Conditions in A City : A Study of Lucknow Metropolis.*
Funded by : Indian Council of Social Science Research (ICSSR), New Delhi w.e.f. : 01/01/2019
- iii. Avijit Sahay, Post Doctoral Fellow at IIT Mumbai
- iv. The identification of Spatial Planning units in Meja Tehsil of Allahabad District, U.P.,
Micro-level Planning for Educational facilities in Meja Tehsil of Allahabad district, U.P.
By Dr. Neelam Mishra, Post Doctoral Fellow (Women) by UGC
- v. Sanyogita Andriyas ,D.S.Kothari Fellowship

Academic Organizations (headquartered in the Department):

S.No.	Name	Nature	Objectives
1.	Indian Institute of Geomorphologists	National	To publish Research Papers To organize conference in different universities /centers To enhance interaction with different research centre/university
2.	Allahabad Geographical Society	National	Do

Journals published by the Department/Centre:

S. No.	Title	Nature	Established	Annual/bi-annual / quarterly	ISSN
1.	Indian Journal of Geomorphology	National	1987	Annual	2320-0731
2.	National Geographers	National	1982	Annual	0470-0929

Proposed Courses

S. No.	Name of Programme	Nature	Duration	Proposed or In process	Intake of Students
1.	Remote Sensing & GIS	Postgraduate Degree Programme	Two years (4 semester)	Proposed	20

Outreach activities:

Siddiqui, A.R

- Delevered lecture on Role of Geo-Spatial Technology in Resource mapping at UGC HRDC,UoA, 06-04-2018
- Delevered lecture on G.I.S Applications and Academic Auditing at UGC HRDC, UoA ,28-06-2018
- Delevered lecture on Role of Satellite derived data at UGC HRDC,University of Allahabad,27-07-2018
- Delevered lecture on Role of Geospatial Technology in desertification mapping at UGC HRDC,UoA 24-09-2018
- Delevered lecture on burn Area Mapping at UGC HRDC,University of Allahabad12-01-2019
- Delivered lecture on Forest Fire Modelling at UGC HRDC,University of Allahabad12-03-2019
- Siddiqui, A.R(2018) delivered two lectures on GIS applications in Forest fire at UGC HRDC,at DDU University, Gorakhpur on 15th February,2019
- Delivered lecture on Application of G.I.S. in Natural Resource Management on 19.01.2018 at UGC HRDC,A.U. 117th orientation Programme at UGCHRDC, University of Allahabad
- Delivered lecture on Concept of Smart City and Role of Intermediate Town in 118th orientation programme, University of Allahabad
- Delivered invited lecture on Role of Satellite data in Desertification Mapping on dated 06.04.2018 at Refresher Course in Environmental Studies , UGCHRDC, University of Allahabad .

- Delivered lecture on G.I.S.Application in land degradation Studies at NRDMS-DST sponsored 21 Days Training Programme on Geo-Spatial Technologies On 13th May,2019
- Delivered lecture on Application of remote sensing and GIS technique in land degradation Studies on December,2018 at UGCHRDC,A.M.U.Aligarh.
- Delivered lecture on Kumbh Mela-A Kumbh of opportunities;Cultural and Economic Aspects at JTPG College, University of Allahabad.
- Acted as Course Coordinator 122nd ORIENTATION programme (04-01-2019 to 31-01-2019)
- Acted as Course Coordinator Summer School In Social Science 21-06-2018 TO 11.07.2018
- Participated in the Short Course on Geospatial Modeling in forestry and ecology for Climate Change response studies organized by Centre for Space Science and Technology Education in Asia and the Pacific (CSSTEAP) affiliated to the United Nation.during April 16-27,2018 at IIRS,Dehradun
- Participated in the Short Course on Disaster Risk reduction(DRR)With Special emphasis on flood and Forest Fires organized by Centre for Space Science and Technology Education in Asia and the Pacific (CSSTEAP) affiliated to the United Nation.during May20-31,2019 at IIRS,Dehradun(U.K)
- Chaired a Session acted as Chairman of the technical session on Geoinformatics and Geomorphology during 30th National Conference of IGI organized by Jamia Millia Islamia University New Delhi
- Chaired A technical at XIII DGSI international Geography Congress on Session on Sustainable Rural Development-Geospatial solutions during 20-22 September 20-22,2018 organised by Bangalore University, Bangalore
- Chaired two technical sessions during an international conference on Global Water Crisis:Agriculture and Food Security in the Era of Climate Change during 1-3 December,2018 organized by Department of Geography,A.M.U.Aligarh
- Elected as Secretary General Indian institute of Geomorphologists on the occasion of 30th IGI Conference organized by Jamia Millia Islamia University,New Delhi during 03-05 October 2018.

Ashwajeet Chaudhary

International Conferences (Oral Presentation) 2018-19

XIII Deccan Geographical Society of India (DGSI) International Conference, Bangalore University Sept 20-22., 2018

Paper Presented:

- 'Water Resource Profile And Assessment Of Supply- Demand Dynamics of Water in Lucknow City'.
- National Conferences (Oral Presentation) 2018-19
- National Seminar on Urban Environment in the 21st Century: Issues and Challenges'', Jamia Millia Islamia March 27-28, 2018.
- 'Spatio-Temporal Assessment of Dynamics of Urban Flooding in Lucknow City'.
- 'Degradation of Natural Water Bodies in Indian Cities: An Assessment'
- 30th IGI National Conference, Jamia Millia Islamia University, New Delhi. Oct. 3-5, 2018
- 'Geo-Environmental Impacts of Solid Waste on Urban Geomorphology: A Case Study of Lucknow City'.
- 'Spatio-Temporal Study of Changing Location Pattern Of Sangam Due To Channel Shifting of River Ganga In Allahabad City'
- 'Glimpses of Micro Geomorphosites Heritage in and around Allahabad District'.
- Chaired the technical session on Natural Resource Management-2 at 30th IGI National Conference at Department Of Geography, Jamia Millia Islamia University, New Delhi.

DEPARTMENT OF HINDI AND MODERN INDIAN LANGUAGES

Introduction:

Established in 1924. First Head of Department Dr. Dharendra Verma was a visionary person. He with cooperation of his colleagues prepared the syllabus in such a form that in higher education scientific knowledge of Hindi Language & Literature might be provided to the students Dr. Uday Narain Tiwari, Dr. Hardeo Bahri -- these are the names, well-known in the field of linguistics. Dr. Mata Prasad Gupta was especially devoted to textual criticism. Dr. Brajeshwar Verma was authentic scholar of Surdas, Dr. Paras Naht Tiwari of Kabirdas, Dr. Dharmvir Bharati was also for some time, attached with the Department has from the very beginning been the centre of learning and creativity in Hindi. We carrying on this tradition onward.

भारत में उच्च स्तरीय हिंदी शिक्षण की आवश्यकताओं को देखते हुए हिंदी विभाग की स्थापना सन् 1924 ई. में की गई. इसके संस्थापक अध्यक्ष प्रो. धीरेन्द्र वर्मा थे. हिंदी विभाग मूलतः 'हिंदी एवं आधुनिक भारतीय भाषा विभाग' है. नामानुरूप इस विभाग में अन्य भारतीय भाषाओं यथा- बांग्ला, तमिल, गुजराती, तेलुगु, पंजाबी और उर्दू का अध्ययन-अध्यापन होता रहा है. लक्ष्मी सागर वाष्णीय, हरदेव बाहरी, जगदीश गुप्त, माताबदल जायसवाल, जगदीश प्रसाद श्रीवास्तव, माता प्रसाद गुप्त, राम कुमार वर्मा, पारस नाथ तिवारी, रघुवंश, राम स्वरूप चतुर्वेदी, सत्य प्रकाश मिश्र, दूधनाथ सिंह प्रभृति विद्वान इस विभाग के शिक्षक रहे हैं.

Thrust Areas:

- Aadi Kavya, Bhakti kavya and Reeti kavya
- Modern Hindi Poetry , Aesthetics and Literature
- Hindi Criticism, Linguistics, Hindi Journalism
- Post Colonialism and Hindi Literature
- Identity Discourse (Feminism, Dalit, Adivasi, LGBTQ...etc.) and Hindi Literature
- Navjagaran and Hindi Literature
- Visual and Performing Arts (Cinema, Theatre, Folk arts etc.)
- Hindi Fiction, Hindi Non-Fiction (Memoir, Travelogue, Autobiography, Biography etc.)
- Hindi Public sphere,
- History of Hindi Literature

Programmes of Study:

S.N.	Programme of Study	Duration	No. of Seats
1.	Ph.D.	5 years (includes course work)	60
2.	M. A./M. Sc.	2 years (4 semesters)	308
3.	B. A./B. Sc.	3 years	977

Faculty members and their Area of Research:

S.N.	Name of Faculty	Gender	Designation	Area of Specialization
1	प्रो. चंदा देवी (अध्यक्ष)	Female	Professor	आधुनिक काव्य, नाटक और रंगमंच
2	प्रो. मीरा दीक्षित	Female	Professor	भाषा विज्ञान
3	प्रो. मुश्ताक अली	Male	Professor	पत्रकारिता और प्रेमचंद
4	प्रो. कात्यायनी सिंह	Female	Professor	नाटक और रंगमंच
5	प्रो. कृपाशंकर पांडेय	Male	Professor	आलोचना
6	प्रो. प्रणय कृष्ण	Male	Professor	आलोचना, छायावाद, काव्यशास्त्र
7	प्रो. संतोष भदौरिया	Male	Professor	आलोचना और पत्रकारिता
8	प्रो. शिवप्रसाद शुक्ल	Male	Professor	आलोचना
9	प्रो. योगेंद्र प्रताप सिंह	Male	Professor	प्रयोजनमूलक हिंदी, भाषा विज्ञान
10	प्रो. लालसा यादव	Female	Professor	विद्यापति, स्त्री विमर्श, प्राचीन काव्य
11	डॉ. सूर्य नारायण सिंह	Male	Associate Professor	आलोचना
12	डॉ. भूरिलाल	Male	Associate Professor	दलित विमर्श

UNIVERSITY OF ALLAHABAD

S.N.	Name of Faculty	Gender	Designation	Area of Specialization
13	डॉ. अमरेन्द्र त्रिपाठी	Male	Associate Professor	आलोचना, भक्ति काव्य
14	डॉ. आशुतोष पार्थेश्वर	Male	Associate Professor	प्रेमचंद, पत्रकारिता
15	डॉ. बसंत कुमार त्रिपाठी	Male	Associate Professor	आलोचना, कविता, नाटक और रंगमंच
16	डॉ. वृजेश कुमार पांडेय	Male	Associate Professor	हिंदी आलोचना, समकालीन कविता
17	डॉ. कुमार वीरेंद्र सिंह	Male	Associate Professor	आलोचना और पत्रकारिता
18	डॉ. राकेश कुमार सिंह	Male	Associate Professor	मध्ययुगीन काव्य, लोक साहित्य
19	डॉ. सुनील विक्रम सिंह	Male	Associate Professor	कथा साहित्य
20	डॉ. राजेश कुमार गर्ग	Male	Associate Professor	भारतीय काव्यशास्त्र, भाषा विज्ञान, मध्यकालीन कविता
21	डॉ. दिनेश कुमार	Male	Assistant Professor	आलोचना, काव्यशास्त्र
22	डॉ. मीना कुमारी	Female	Assistant Professor	आधुनिक कविता, उपन्यास, भाषा विज्ञान, स्त्री विमर्श, प्रयोजनमूलक हिंदी
23	डॉ. सुधा त्रिपाठी	Female	Assistant Professor	हिंदी साहित्य का इतिहास, सिनेमा, आधुनिक कविता
24	डॉ. चितरंजन कुमार	Male	Assistant Professor	आलोचना, कथा साहित्य
25	डॉ. विनम्रसेन सिंह	Male	Assistant Professor	कथा साहित्य, मध्ययुगीन काव्य और काव्यशास्त्र
26	डॉ. अमृता	Female	Assistant Professor	कथा साहित्य, पत्रकारिता
27	डॉ. सुजीत कुमार सिंह	Male	Assistant Professor	कथा साहित्य और काव्यशास्त्र
28	डॉ. सुरभि त्रिपाठी	Female	Assistant Professor	स्त्री विमर्श
29	डॉ. अमितेश कुमार	Male	Assistant Professor	नाटक और रंगमंच, आधुनिक साहित्य
30	डॉ. संतोष कुमार सिंह	Male	Assistant Professor	आलोचना
31	डॉ. हेमराज डोगरा	Male	Assistant Professor	कविता, आलोचना
32	डॉ. सुनील कुमार सुधांशु	Male	Assistant Professor	नाटक एवं रंगमंच
33	डॉ. शिव कुमार यादव	Male	Assistant Professor	हिंदी आलोचना, आधुनिक साहित्य
34	डॉ. दीनानाथ मौर्य	Male	Assistant Professor	हिंदी आलोचना, नाटक और रंगमंच, कथा साहित्य
35	डॉ. लक्ष्मण प्रसाद गुप्ता	Male	Assistant Professor	हिंदी कविता, ग़ज़ल
36	डॉ. अंशुमान कुशवाहा	Male	Assistant Professor	आलोचना और कथा साहित्य
37	डॉ. विजय कुमार रविदास	Male	Assistant Professor	हिंदी आलोचना और दलित साहित्य
38	डॉ. गाजूला राजू	Male	Assistant Professor	आधुनिक साहित्य, अस्मितामूलक विमर्श
39	डॉ. वीरेन्द्र कु. मीणा	Male	Assistant Professor	साहित्य का इतिहास, अस्मितामूलक विमर्श, आदिकाल
40	डॉ. जनार्दन	Male	Assistant Professor	सिनेमा, पत्रकारिता, अस्मितामूलक विमर्श

Support Staff:

S.N.	Name	Gender	Category	Designation	Work assigned
1.	Rajnath Yadav	Male	OBC	Office Assistant	Office Managemnet
2.	Lovelesh Mishra	Male	GEN	Typist	Typing
3.	Muralidhar Mishra	Male	GEN	Peon	MTS
4.	Ramasare	Male	SC	Peon	MTS
5.	Anil Kumar	Male	OBC	Peon	MTS

Details of Students, Year wise and Reservation wise (2018-2019):

Course	Gen			OBC			SC			ST			TOTAL		
	Male	Female	Total	Male	Female	Total	Male	Female	Total	Male	Female	Total	Male	Female	Total
PG	153	94	247	76	49	125	54	33	87	13	9	22	296	185	481
UG	549	129	678	994	247	1241	432	107	539	29	11	40	2004	494	2494
Total	702	223	925	1070	296	1366	486	140	626	42	20	62	2300	679	2975

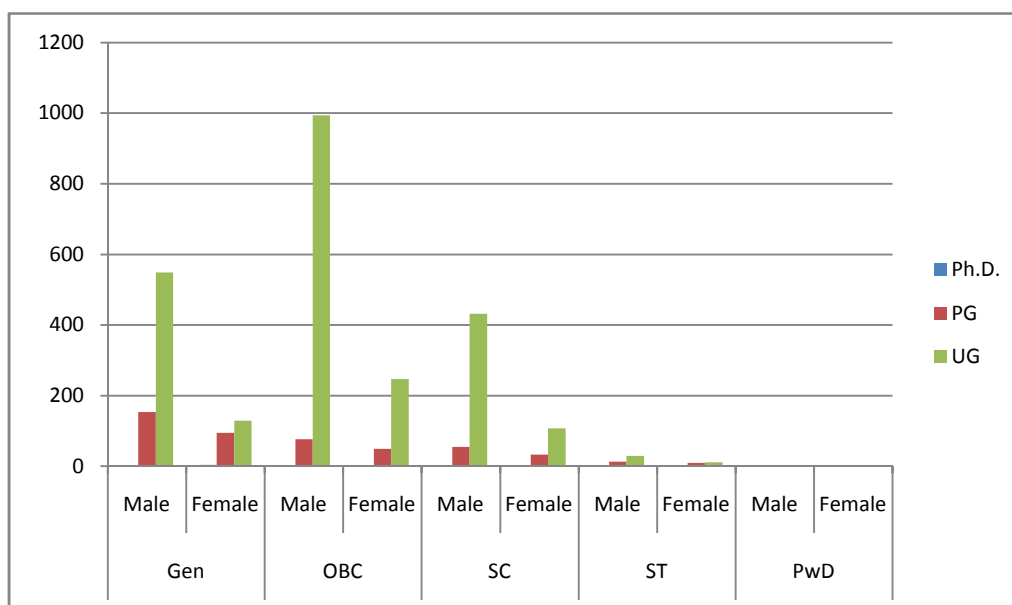

Student Enrollment for the Department

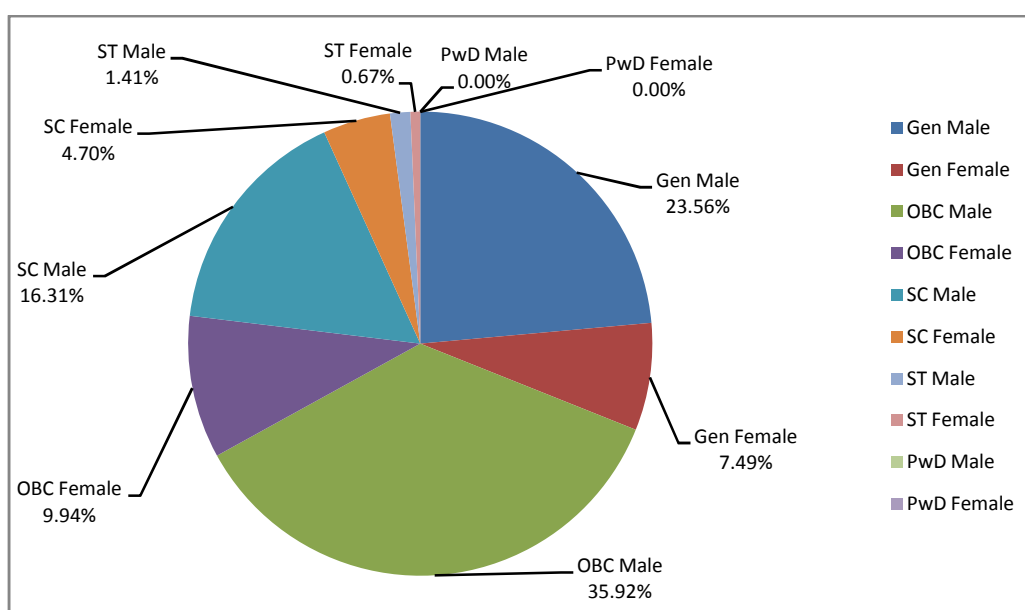

Gender wise distribution of Students

Training/orientation/refresher courses/special lectures conducted by the Department/Centre:

S.N.	Name of the course	Duration and dates	Funding/sponsor	Speakers
1.	राजभाषा और हिंदी	11 सितम्बर 2018	Rajbhasha Vibhag, AU	Suniti Sharma
2.	प्रो. रामस्वरूप चतुर्वेदी व्याख्यान	28 जुलाई 2018,	Hindi Dept., AU	प्रो. रविभूषण, राजेंद्र कुमार, राम किशोर शर्मा, प्रणय कृष्ण

Awards/Honours/Fellowship received:

S.N.	Name of Faculty Member/ Student who received award	Name of the award	Organization conferring award
1.	Prof. Yogendra Pratap Singh	उत्तर प्रदेश भाषा सम्मान 2018	उत्तर प्रदेश भाषा संस्थान
2.	Dr. Bhoorelal	एक्सिलेंट टीचर अवार्ड, 2018	इलाहाबाद विश्वविद्यालय
3.	Dr. Vinamrasen Singh	भोला नाथ तिवारी साहित्य सम्मान 2018,	उत्तर प्रदेश हिंदी संस्थान, लखनऊ

Academic Organizations (headquartered in the department/Centre):

S.No.	Name	Nature	Objectives
1.	Bhartiya Hindi Parishad	National	Hindi Language and Literature
2.	Hindi Parishad Prakashan	National	Publication, Journals, Textbook
3.	Bhartiya Hindi Parishad	National	Publication, Journals

Journals published by the Department/Centre:

S.No.	Title	Nature	Established	Frequency	ISSN
1.	Kaumudi	National	1924	Annual	
2.	Anusandhan	National	1924	Bi Annual	2249-9318
3.	Hindi Anushilan	National	1942	Quarterly	2249-930X

Outreach activities:

S. N.	Name of Faculty Member/Student / Researcher	Title of the paper presented	Title of Conference/ Seminar etc	Duration of the assignment	Organized by
1.	प्रो.योगेन्द्र प्रताप सिंह	प्रौद्योगिकी एवं हिंदी	ग्यारहवां विश्व हिंदी सम्मेलन, मॉरीशस	18- 20 अगस्त 2018	विदेश मंत्रालय, भारत सरकार
		जनसंचार माध्यम एवं भारतीय संस्कृति	ग्यारहवां विश्व हिंदी सम्मेलन, मॉरीशस	18- 20 अगस्त 2018	विदेश मंत्रालय, भारत सरकार
		हिंदी का वैश्विक परिप्रेक्ष्य	विश्व मातृभाषा दिवस	10 January 2019	राजभाषा अनुभाग, इलाहाबाद विश्वविद्यालय
		लोकभवन सचिवालय, लखनऊ	उत्तर प्रदेश के सभी संस्थानों/ आयोगों/ बोर्ड की बैठक में उत्तर प्रदेश हिंदी संस्थान का प्रतिनिधित्व	1 November 2018	उत्तर प्रदेश सरकार
		बीज वक्तव्य	वैश्विक संस्कृति के उन्नयन में भारत की भूमिका, राष्ट्रीय संगोष्ठी	30-31 January 2019	हिंदुस्तानी एकेडमी एवं श्यामा प्रसाद मुखर्जी राजकीय महाविद्यालय, प्रयागराज
		हिंदी की कथेतर साहित्य सर्जना	International Seminar	6 to 9 December	वीके विडला कॉलेज ऑफ आर्ट्स साइंस एंड कॉमर्स, कल्याण मुंबई और भारतीय हिंदी परिषद
		विशेष व्याख्यान	राष्ट्र की अवधारणा और आज का भारत	27 December 2018	हिंदुस्तानी एकेडमी
		विशेष व्याख्यान	पत्रकारिता और साहित्य का अंतः संबंध: वर्तमान संदर्भ	14 July 2018	हिंदुस्तानी एकेडमी
		रीसोर्स पर्सन	कार्यशाला: कहानी रचना प्रक्रिया; समस्या और सुझाव	13 October 2018	हिंदुस्तानी एकेडमी
		विशेष व्याख्यान	राजभाषा- हिंदी के परिप्रेक्ष्य में (संगोष्ठी)	13 October 2018	हिंदुस्तानी एकेडमी
		विषय विशेषज्ञ	पाठ्यक्रम निर्धारण समिति	26 Nov, 2018	इयू, दिल्ली
		विषय विशेषज्ञ	पुस्तक निर्माण कार्यशाला	8 सितम्बर 2018	केंद्रीय हिंदी संस्थान, आगरा
		राजनीति, कार्य संस्कृति एवं एकात्म दर्शन	व्याख्यानमाला	11 अगस्त 2018	महाराणा प्रताप स्नातकोत्तर महाविद्यालय, गोरखपुर
		विशिष्ट वक्ता	लोकभाषा संवर्धन में नाथपंथ का योगदान	22-23 October 2018	महाराणा प्रताप स्नातकोत्तर महाविद्यालय, गोरखपुर
		विशिष्ट वक्ता	शब्द रंग साहित्य महोत्सव	26 November 2018	डॉ. राममनोहर लोहिया विधि विश्वविद्यालय, लखनऊ.

S. N.	Name of Faculty Member/Student/ Researcher	Title of the paper presented	Title of Conference/ Seminar etc	Duration of the assignment	Organized by
		विशिष्ट वक्ता	हिंदी पत्रकारिता: स्वाधीन चेतना और युगबोध	30-31 May 2018	लखनऊ विश्वविद्यालय
2.	प्रो. शिव प्रसाद शुक्ल	विषय विशेषज्ञ	कबीर जयन्ती	30 June 2018	गुजरात प्रचार समिति, बड़ौदा, गुजरात
		व्याख्यान	छायावाद के सौ वर्ष	30 अक्टूबर 2018	सीएमपी डिग्री कॉलेज, प्रयागराज
		व्याख्यान	नीरज खरे की आलोचना	10 November 2018	मीरा स्मृति समिति, प्रयागराज
		विषय विशेषज्ञ	मीडिया और हम	1-2 February 2019	MS University, Vadodara, Gujrat
		विषय विशेषज्ञ	हिंदी गालो कोश	03 to 10 February 2019	केंद्रीय हिंदी संस्थान, आगरा.
3.	प्रो. संतोष भदौरिया	किसान चेतना के कवि केदार		1 अप्रैल 2018	केदार स्मृति न्यास, बांदा
		आज का समय और गांधी		3 अप्रैल 2018	इलाहाबाद केंद्र, म.गा. अं. हिंदी विश्वविद्यालय, वर्धा
		व्यंग्य सप्तक पुस्तक पर वक्तव्य		19 May 2018	हिंदुस्तानी भाषा अकादमी, बनारस
		मुक्तिबोध की कविताई	मुक्तिबोध समय से संवाद	24 नवम्बर 2018	आगाज़, झांसी
		समाचारों की दुनिया	मीडिया कार्यशाला	30 नवम्बर 2018	जगततारण डिग्री कॉलेज, इ.वि.वि.
		आलोचना का वर्तमान	रामविलास शर्मा आलोचना सम्मान समारोह	14 December 2018	केदार स्मृति न्यास, बांदा
		उपन्यास 'काली धार' पर वक्तव्य	समानांतर साहित्य उत्सव	27-29 January 2019	प्रलेस, जयपुर
		कहानी संग्रह 'राग मारवा' पर वक्तव्य	संगोष्ठी	03 March 2019	बैकस्टेज, इलाहाबाद
		Special Lecture	Faculty Development Programme	11 March 2019	ईश्वरशरण डिग्री कॉलेज, इ.वि.वि.
4.	सूर्यनारायण	हिंदी का वैश्विक परिप्रेक्ष्य	विश्व मातृभाषा दिवस	10 January 2019	राजभाषा अनुभाग, इलाहाबाद विश्वविद्यालय
5.	Amitesh Kumar	हिंदी का वैश्विक परिप्रेक्ष्य	विश्व मातृभाषा दिवस	10 January 2019	राजभाषा अनुभाग, इलाहाबाद विश्वविद्यालय
		सोशल मीडिया के दौर में हिंदी	Invited Lecture	14 सित. 2018.	युइंग क्रिश्चियन कॉलेज, इलाहाबाद
		'लेखन शैली को बेहतर कैसे बनाएं'	राष्ट्रीयहिंदीलेखनकार्यशाला	18 अगस्त 2018	इलाहाबाद संग्रहालय, सीईआरटी और हिंदी विभाग, इ.वि.वि.
6.	Amrendra Tripathi	Uttar Bharat kee Sant parampara aur mahapurush Shankardev	Bhakti Sahitya aur Sant Kabir	27-28 Jan, 2018	Kendriya Hindi Sansthan, Agra
		Hindi avam Asamiya me ekatmata ke Swar	Bharatiya Bhashawon ke Ekatmta aur Vaigyanikta	14-15 March, 2018	Deptt. Of Hindi, DHSGV, Sagar
		Baudha Darshan kee prasangikta	Vartman Pariprekshya me Baudha Darshan	30 April, 2018	Kesariya Mahotsav, Kesariya, East Champaran
		Maulana abul kalam aazad kee shiksha niti kee prasangikta	Rastriya shiksha aur samkaleen samaj	11 Nov, 2018	Allahabad University, Allahabad
		Bharatiya sahitya kee awadharana Aur Poorvotter Bharat	Poorvotter bharat kee janjatiyon ka darshan evam sanskriti	15-16 Nov, 2018	Deptt. Of Hindi, RGU, Itanagar
		Ramvilas sharma ka `Rastra` sambandhi chintan	Aadhunik bharat me rastravad: Parikalpana aur chunautiyan	21-22 Dec, 2018	Sri Jay Narayan Snatkottar mahavidyalaya, Lucknow
7.	Amrita	Nai Kavita Aur Kedarnath	Banaras. Bhojapuri Aur Kedarnath	26, 27 October, 2018	B.H.U. Varanasi
		Tanav:Karan Aur Prabhav	Veidik Vangmay:Parampara Aur Adhunik Vigyan Ka Mul	26,27 February 2019	G.K.V.Haridwar
8.	Raju Gajula	Telangana ke Komaram Bhim aur unka Sangharsh	Ekkisveen Sadi Aadivasi Samaj:Sahitya Lekhan ki Chunoutiyan aur Sambhavanayen	19-20 April 2018	Department of Hindi, IGNTU Amarkantak.M.P
		Maulana Abul Kalam Azaad aur nayi siksha neeti	Rashtriya Siksha aur Samkaleen Samaj	11 November 2018	Allahabad University, Allahabad

UNIVERSITY OF ALLAHABAD

S. N.	Name of Faculty Member/Student/ Researcher	Title of the paper presented	Title of Conference/ Seminar etc	Duration of the assignment	Organized by
9.	Kumar Birendra	Badalte Samay Ke Prashn Aur Jharkhand Ka Katha Sahitya, Jharkhand Ka Hindi Sahitya,	Special Lecture, P.G. Hindi Department	06-07 September 2018	Nilamber-Pitamber University, Medininagar, Palamu, Jharkhand.
		Asmitamulak Vimarsh Kee Aavshyкта, Chetna, Drishti, Vimarsh, Saundaryashastra,	Refresher Course	05 December, 2018	HRDC Ranchi University, Ranchi.
		Third Jender Vimarsh: Anya Vimarshon Se Bhinnता Kee Sthiti; Sambhavna Aur Simayen	Refresher Course	05 December, 2018	HRDC Ranchi University, Ranchi.
		'Sahitya Aur Vigyan: Antahsambandh', Recent Trends in Research in Applied Sciences. An Interdisciplinary Approach	National Conference	07 December 2018	Ganesh Lal Agrawal College, Nilamber-Pitamber University, Medininagar, Palamu, Jharkhand.
10.	Ashutosh Partheshwar	Premchand Ke Sapnon Ka Bharat Aur Soze-Watan	Premchand Ke Sapnon Ka Bharat	31 July 2018	PWA, Allahabad
		Hindi-Urdu Ki Sajhi Virasat Ke Alambardar : Premchand	Hindi-Urdu Ki Sajhi Virasat Ke Alambardar : Premchand	19 January 2019	FACTS, Raipur
11.	Basant Kumar Tripathi	Premchand ka Bharat (Lecture-Chief Guest)	Premchand ka Bharat	28 July 2018	Bhartiya Bhasha Parishad Kolkata
		Samay, Samaj aur Sahitya (Lecture)	Samay, Samaj aur Sahitya	23 Dec 2018	Maharashtra Rashtrabhasha Sabha, Nagpur
		Sahitya ka Desh-Kaal (Lecture)	Sahitya ka svabhav	6 Dec 2018	Nirala ke Nimitta, Prayagraj
		Manoj Rupada ka katha sansar	Bhid tantra banam Loktantra	18 Nov 2018	Kathakram, Lucknow
12.	Dina Nath Maurya	Hindi ki Lokdharmi Parmpra aur Kedar nath singh	Banaras, Bhojpuri Aur Kedarnath	26, 27 October 2018	BHU Varanasi
		Vaisvik Sanskriti avam Sahitya Ka Antarsambandh	Vaisvik Sanskriti ke unnyayan men Bharat ki Bhoomika	30-31 January 2019	Hindustani Academy Allahabad
		Resource person	e- content development Workshop	18-20 March 2019	NCERT New Delhi
13.	Janardan	Gondi se Prachin Bhartiya Itihas ko Samajha ja sakta hai.	National Tribal literary festival	14-16 December, 2018	National museum of Anthropology, Bhopal
14.	Meena Kumari	<i>Kedarnath Singh ka Vimabalok</i>	Banaras, Bhojpuri Aur Kedarnath Singh	26-27 October, 2018	Bhojpuri Adhayan Kendra, Kala Sankay, B.H.U.
		<i>Bhojpuri aur Maithili Lokgeeton mein Pratibimb Lok-Sanskriti</i>	Lok Aur Aadhunika	29-30 Nov, 2018	Bhojpuri Adhayan Kendra, Kala Sankay, B.H.U.
		Miathili Aur Hindi Lokgeeton ka Stri-Swar	Stri-Lekhan ke Aadi Hastakshar	29-30 March, 2019	Hindi Vibhag, B.H.U., Varanasi
15.	Brijesh Kumar Pandey	आधुनिक भारत में राष्ट्रवाद परिकल्पना और चुनौतियां		21-22 December 2018	हिंदी विभाग, जयनारायण व्यास स्नातकोत्तर महाविद्यालय लखनऊ
		स्वातंत्र्योत्तर साहित्य से राष्ट्रवादी चिन्ता	Special Lecture	03 March 2019	औरंगा हिंदी प्रोत्साहन निधि
		राष्ट्रीय शिक्षा और समकालीन समाज	शोध पत्र	11 November 2018	इलाहाबाद विश्वविद्यालय
		वर्तमान परिप्रेक्ष्य में राष्ट्रभावना का विकास में हिंदी साहित्य की भूमिका			लक्ष्मण सिंह राजकीय स्नातकोत्तर महाविद्यालय, पिथौरागढ़
		हिंदी मिसौंग अध्ययन निर्माण कोश	Resource Person, Workshop	29 March -03 April	केंद्रीय हिंदी संस्थान, आगरा
16.	दिनशा कुमार	लोकतंत्र बनाम भीड़तंत्र रचनात्मक चुनौतियां	Special Lecture	18 नवम्बर 2018	कथाक्रम

**DEPARTMENT OF JOURNALISM
AND MASS COMMUNICATION**

Introduction:

The two year PG Diploma in Journalism & Mass Communication was commenced in year (1984-85) under the dept. of Political Science. The dept. got its independence existence in year 1993. In year 2000, Post graduate (PG) and Bachelor of Journalism & Mass Communication program has begun. In year 2007, MA (Mass Communication) was started, which is semester based program; the sanctioned student strength is about ninety four (94).

Thrust Areas:

1. Television production and documentary making
2. Radio program production
3. Print Media

Programmes of Study:

S. No.	Programme of Study	Duration	No. of Seats
1.	M. A.	2 years	90

Faculty members and their Area of Research:

S.N.	Name of Faculty	Gender	Category	Designation	Area of Specialization
1.	Sunil Umarao	Male	OBC	Asst. Professor	Film and electronic Media

Support Staff:

S.N.	Name	Gender	Category	Designation	Work assigned
1.	Pradeep Kumar Srivastava	M	Gen	Office Assistant	Official Work
2.	Chandra Kishor Tripathi	M	Gen	Junior Office Assistant	Official Work
3.	Ram Asare	M	OBC	Peon	Official Work

Details of Students, Year wise and Reservation wise (2018-2019):

Course	Gen			OBC			SC			ST			PwD			TOTAL		
	Male	Female	Total	Male	Female	Total	Male	Female	Total	Male	Female	Total	Male	Female	Total	Male	Female	Total
PG (M.A.)	40	04	44	17	01	18	08	03	11	01	00	01	00	00	00	66	08	74

Seminars/Workshops/Conferences conducted by the Department:

S. No.	Name of the Seminar/ workshop/conference	National / International	Duration and dates	Funding/sponsor Agenc(y/ies)	No. of Participants
1.	National level workshop by Mr. Rajesh Badal, Sr. Executive, Rajya Sabha TV New Delhi	National	14/02/2017	University of Allahabad	300

Proposed Courses

S.N.	Name of Programme	Nature	Duration	Intake of Students
1.	BAMC	Degree	3 years	30
2.	Diploma courses in Script writing, Photography & Development Journalism.	Diploma	1 Year	30

A. Other Projections:

- a. Community Radio Center.
- b. New Media Center.

DEPARTMENT OF MEDIEVAL AND MODERN HISTORY

Introduction:

Established in 1912 under the leadership of Rushbrook Williams, the department of Medieval/Modern History developed under great scholars like Prof Shafaat Ahmad Khan, Prof RP Tripathi, Prof CB Tripathi etc. The collective efforts of these scholars led to the growth of Allahabad School of History which had been relevant and innovative in developing history as an academic discipline.

Thrust Areas:

- History of Marginalized Communities
- History of Indian Cinema
- History of Science & Technology
- History of Indian Diaspora

Programmes of Study:

S.N.	Programme of Study	Duration	No. of Seats	Specialization(s)
1.	Ph.D.	5 years (includes course work)	As per prescribed norms	Medieval/Modern History
2.	M. A./M. Sc.	2 Years	185	Medieval/Modern History
3.	B. A./B. Sc.	3 Years	1200	Not Required

Faculty members and their Area of Research:

S.N.	Name of Faculty	Gender	Category	Designation	Area of Specialization
1.	Dr. Alok Prasad	Male	SC	Professor	Modern History
2.	Dr. Heramb Chaturvedi	Male	Gen	Professor	Medieval History
3.	Dr. Lalit Joshi	Male	Gen	Professor	Modern History
4.	Dr. P L Vishwakarma	Male	OBC	Professor	Medieval History
5.	Dr. P S Harish	Male	Gen	Assistant Professor	Medieval History
6.	Dr. Sanjay Srivastava	Male	Gen	Professor	Medieval History
7.	Dr. Vikram Harijan	Male	SC	Assistant Professor	Medieval History
8.	Dr. Yogeshwar Tewari	Male	Gen	Professor	Medieval History

Support Staff:

S.N.	Name	Gender	Category	Designation	Work assigned
1.	R K Shukla	Male	General	Office Assistant	Departmental Official Work
2.	S N Shukla	Male	General	Office Assistant	Departmental Official Work
3.	Bhanu Pratap Singh	Male	General	Peon	Departmental Official Work
4.	Imam Ali	Male	OBC	Peon	Departmental Official Work
5.	Shiv Prasad	Male	SC	Peon	Departmental Official Work
6.	Saiyid Ali	Male	SC	Sweeper	Cleaning

Details of Students, Year wise and Reservation wise (2018-2019):

Course	Gen			OBC			SC			ST			PwD			TOTAL		
	Male	Female	Total	Male	Female	Total	Male	Female	Total	Male	Female	Total	Male	Female	Total	Male	Female	Total
Ph.D.	11	06	17	13	06	19	07	01	08	00	01	01	00	00	00	31	14	45
PG	39	15	54	61	11	72	34	13	47	02	00	02	04	01	06	140	40	180
UG	692	190	882	990	142	1132	415	64	479	14	07	21	15	05	20	2126	408	2534
Total	742	211	953	1064	159	1223	456	78	534	16	8	24	19	6	26	2297	462	2759

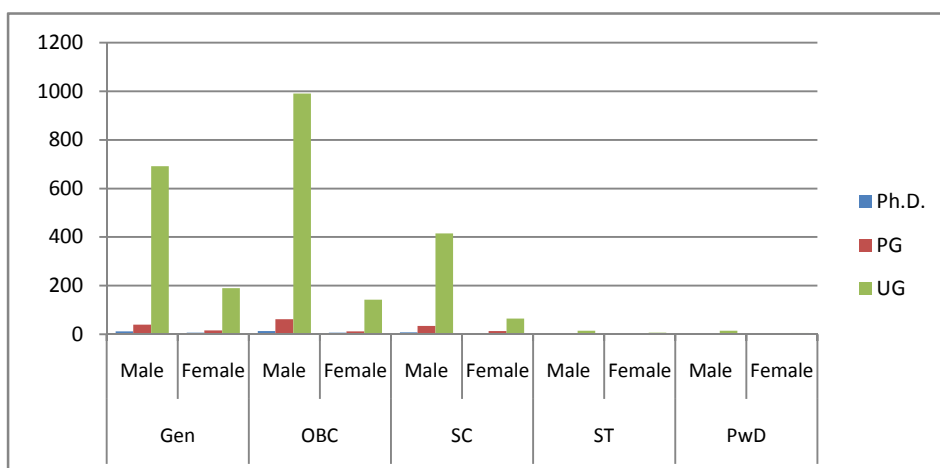

Student Enrollment for the Department

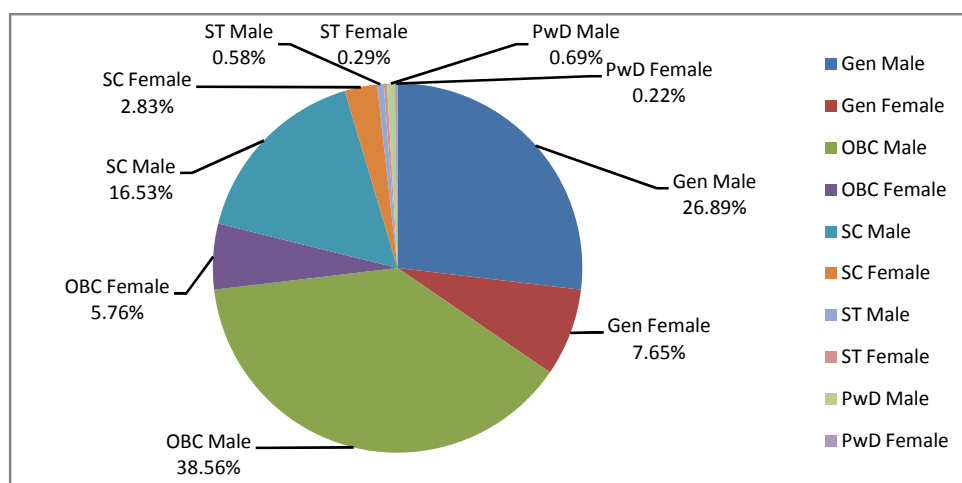

Gender wise distribution of Students

Seminars/Workshops/Conferences conducted by the Department/Centre:

S. No.	Name of the Seminar/workshop/conference	National / International	Duration and dates	Funding/sponsor Agency(ies)	No. of Participants	No. of Papers presented
1.	Problem of Caste in India: Investigating History and Historiography	National	November 29, 30, 2018	ICSSR, Regional Centre, New Delhi, ICHR	94	74

Proposed Courses

S.No.	Name of Programme	Nature	Duration	Proposed or In process
1.	P.G. Course in Medieval Archaeology	Post Graduation	2 Years	In process
2.	Museum Studies	Diploma	1 Year	In process

Outreach activities

S.N.	Name of Researcher	Title of the paper presented	Title of Conference/Seminar etc	Duration of the assignment	Organized by
1.	Dr P S Harish	Military Organization in Tanjore (17 th and 18 th centuries)	South Indian History Congress	February 8-10, 2019	Osmania University, Hyderabad
2.	Dr Vikram Harijan	Dalit Intellectuals in North India	Indian History Congress	February 26-28, 2019	Barkatullah University, Bhopal

DEPARTMENT OF MUSIC AND PERFORMING ARTS

Introduction:

- In our university Music Association was started in the year 1926 initiated by Dr. D. R. Bhattacharya.
- Further from 1929 to 1937, an All India Allahabad University Music conference was organised every year.
- Jr. diploma in music in 1935 and Sr. Diploma in 1942 started.
- Regular U.G course was introduced in the year 1945 and appointment of Prof U.S. Kochak was done as first regular teacher.
- Present building was constructed in the year 1971. Thereafter P .G course and subsequently research work in music began.
- M.P.A in the Professional course curriculum in Music (Vocal/Sitar/Tabla) B. Mus course (now known as B.P.A) began in 2003-04 and thereafter M. Mus (Now M.P.A) 2006-2007.
- Many alumni of the department emerged as national level artists and occupied important positions.
- Most of the teachers of the department are excellent in academics and professional skill at National/ International level and Top grade /A grade artist of all India Radio/Dordarshan and empanelle in I.C.C.R, Govt. of India, New Delhi. They have sound background in having come from Gharanedar Parampara, Guru Shishya tradition.

Thrust Areas:

- To enable our students, after getting traditional teaching under Guru Shishya, Parampara, is becoming performing Arts is their respective field.
- To provide teaching in Musicology aspect of Music.
- To provide teaching in Dhrupad /Dhamar, Tappa, Thumri in vocal Music, Swar Vadya Pakhawaj with Tabla.
- To provide Music Teaching job oriented viz Music critic, Music Recording, Music Director, Music arranging.
- To develop Audio-Visual recording (Digital

Programmes of Study:

S.No.	Programme of Study	Duration	No. of Seats	Specialization(s)
1.	Ph. D.	5 years (includes course work)	08+1(PH) & 1 Special Case	Vocal/Sitar/Tabla
2.	M. A.	4 Semesters	30/30/30	Vocal/Sitar/Tabla
3.	M. P.A.	4 Semesters	15/15/15	Vocal/Sitar/Tabla
4.	B. A.	3 Years	Vocal 40 Sitar- 40 Tabla- 40	Not Required
5.	B. P.A.	4 Years	30/25/25	Vocal /Sitar/Tabla

Faculty members and their Area of Research

S.No.	Name of Faculty	Designation	Area of Specialization
1.	Dr. Dharmpal	Assistant Professor	Vocal (Khyal)
2.	Dr. Jayant Khot	Professor & Head	Vocal (Khyal)
3.	Dr. Jyoti Mishra	Assistant Professor	Vocal (Khyal/Thumri/Dadra)
4.	Dr. Prem Kumar Mallick	Professor	Vocal (Dhrupad/Dhamar/Khyal)
5.	Dr. Rashmi Dixit	Professor	Sitar
6.	Dr. Renu Johri	Associate Professor	Tabla
7.	Dr. Sahitya Kumar Nahar	Professor	Sitar & Musicology
8.	Dr. Vidyadhar Prasad Mishra	Professor	Vocal (khyal/Thumri/Dadra)
9.	Dr. Vishal Jain	Assistant Professor	Vocal (Dhrupad/Dhamar)

Support Staff:

S.No.	Name	Gender	Category	Designation	Work assigned
1.	Sri Ajay Kumar	M	Gen	Sr. Office Asstt.	Office Work
2.	Smt. Anuradha	F	OBC	Jr. Office Asstt.	Office Work
3.	Dr. Vinod Kumar Mishra	M	Gen	Tabla Accompanist	Accompanying
4.	Dr. Girdhar Gopal Mishra	M	Gen	Tabla Accompanist	Accompanying
5.	Smt. Kamini Devi	F	OBC	Peon	Peon Work
6.	Smt. Prema Devi	F	SC	Sweeper	Sweeping

Details of Students, Programme wise and Reservation wise (2018-2019):

Course	Gen			OBC			SC			ST			PwD			TOTAL		
	Male	Female	Total	Male	Female	Total	Male	Female	Total	Male	Female	Total	Male	Female	Total	Male	Female	Total
Ph.D.	00	04	04	02	01	03	02	01	03	00	00	00	00	00	00	04	06	10
PG	05	36	41	10	28	38	08	05	13	00	01	01	00	00	00	23	70	93
UG	22	20	42	14	07	21	15	06	21	00	01	01	00	00	00	51	34	85
Total	27	60	87	26	36	62	25	12	37	00	02	02	00	00	00	78	110	188

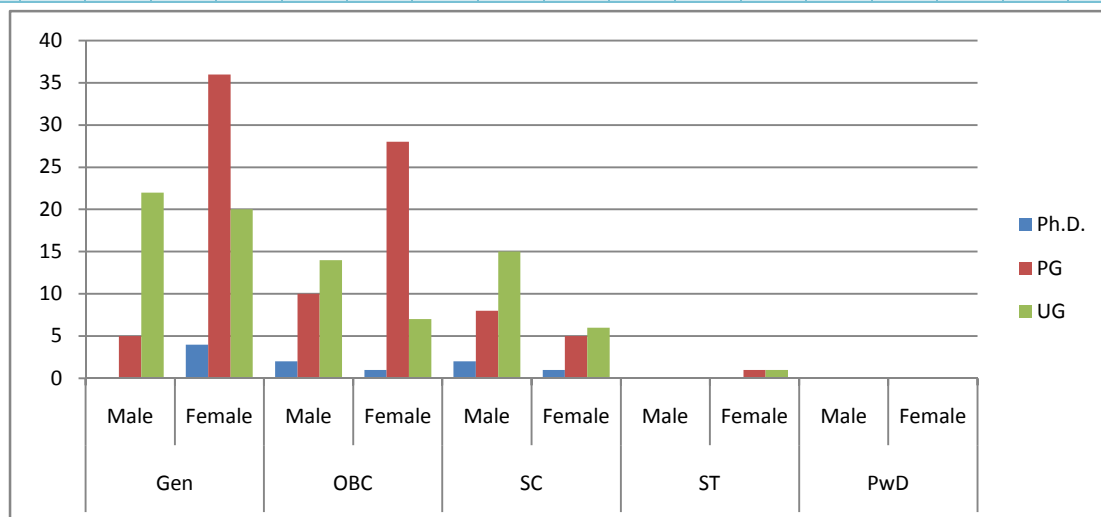

Student Enrollment for the Department

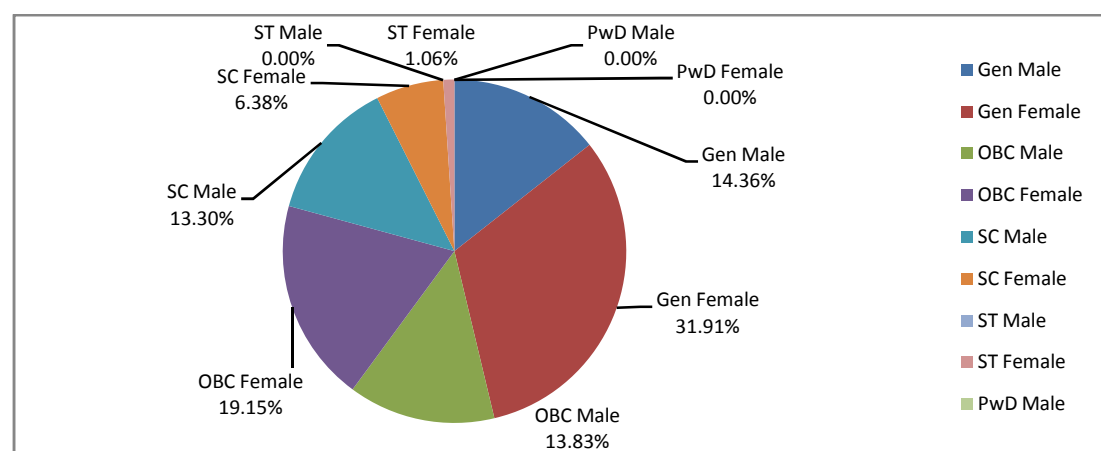

Gender wise distribution of Students

Awards/ Honours/Fellowship received:

S. No.	Name of Faculty Member/ Student who received award	Name of the award	Organization conferring award
1.	Prof Jayant Khot	Excellence Award	Allahabad University
2.	Dr. Renu Johri	National women's achievement award	Poonam Sant Evam Vikas Samiti & Sarwajanhitye Udhog Vyapar Association., Prayagraj
3.	Dr. Jyoti Mishra	National women's achievement award	Poonam Sant Evam Vikas Samiti & Sarwajanhitye Udhog Vyapar Association., Prayagraj

Future Projections

We are planning to develop our department in various manners:-

- Subject and Faculty:- Expansion of vocal teaching programme and to add Dhruwad/Dhamar, Thumri, Dadra, Tappa. In Instrumental Swar vadya Group to begin teaching in Sarod, Flute, Guitar, Violin etc and Avanaddha vadya- Pakhawaj.
- Instruments and equipments in our lab according to the need to begin above mentioned courses.
- Infrastructure for classes:- completion of the 1st floor of the present music Dept building which was approved earlier .
- Establishment of Audio/Visual digital recording lab and digital library.

Outreach activities

S.N.	Name of Faculty Member/Student/ Researcher	Title of the paper presented	Title of Conference/ Seminar etc	Duration of the conference/ assignment	Organized by
1.	Prof. P. K. Mallick	Lecture	Refresher Course	Sept 2018	UGC, FRDC A.U.
2.	Dr. Jyoti Mishra	आधुनिक जीवन शैली एवं प्रदर्शन कलाएं	आधुनिक जीवन शैली एवं प्राच्य विद्यायें	7.4.2018 - 08.04.2018	Sarvbhaumik Prachya Vidya Sasthan, Varanasi
		state coordinator	global folk culture: Traditions and its Reflections	4.10.2018- 6.10.2018	Banaras Hindu University, Varanasi
		Participation	Refresher Course on Visual & Performing Arts	24.08.2018 - 13.9.2018	UGC, FRDC A.U.
		Subject Expert Vocal	one month workshop	19.05.2018 -18- 6.2018	Allahabad Museum Ministry of Culture Indian GOVT.
		Convener	Taal Martand Pt. Nandu Ji Smriti Vyakhyan Evam Pradarshan	01-02-2019	IACP, & Utsah Uddeepan Allahabad
3.	Prof. Jayant Khot	Lecture Demonstration		2018	Jagat Taran Degree College, Alld
		Workshop	Tappas	25-26 Feb, 2019	Mumbai University
		Workshop	Tappa	8 March 2019	Delhi University
		Lec. Dem	Sangeet Parv	2019	Arya Kanya Degree College, Prayag Raj
4.	Prof. Prem Kumar Mallick	Interview	Amrit Rasvadan	2018	Patna Akashvani
		Performance	Arpan Fusible	2018	Pt. Vidur Mallick Academy , Alld
		Interview	Independence Day	2018	Lok Sabha Chanel New Delhi
		Performance	Pt. Kumar Lal Mishra Smriti Samaroh	2018	Pt. Samta Prasad Trust , Allahabad
		Performance	Dhruwad Festival	2018	Jawahar Kala Kendra Jaipur
		Performance	24 th Akhil Bhartiya Dhruwad Nad Ninad Virasdat Samaroh	2018	sangeet Natak Academy, New Delhi
		Performance	Anahad Music Festival	2018	Dhruwadam , New Delhi
		Performance	Akhil Bhartiya Dhruwad Mela	2018	Vartanasi
		Performance	12 th Pt. Vidur Mallick Sangeet Samaroh	2018	WIC Dehradun
5.	Prof. Sahitya Kumar Nahar	Lec Dem	Refresher Course	Sept 2018	UGC, FRDC A.U.
		Performance	Ustad Amir Khan Samiti	May 2018	New Delhi
		Performance	Sangeet Vidha	Sept, 2018	Bhopal, M. P.
		Subject Expert	V.B.S. University , Jaunpur	May 2018 & Feb, 2019	Jaunpur, U. P.

DEPARTMENT OF PHILOSOPHY

Introduction:

The Department of Philosophy established in 1922 is one of the biggest and most prestigious department of the country having around 2500 students on roll. The outstanding faculty members of the Department, Prof. P.S. Burrell (the Founding Head), Prof. H.N.Randle, Prof. R.D. Ranade, Prof. A.C. Mukherjee, Prof. R.N. Kaul and Prof. S.L. Pandey. Among them, Prof. A.C.Mukherjee was honoured Padmashri. Research on Prof. A.C.Mukherjee has been currently undertaken at Berkeley University. A student of Berkeley University has just visited the Department to collect data related to A.C.Mukherjee. Prof. R.D.Ranade was invited by Dr. Rajendra Prasad, the then President of India, to speak on Bhagavad Gita and Mysticism at Rashtrapati Bhavan. The Department has been known for the 'Allahabad School of Philosophy' for innovating a unique epistemological concept 'Depth Epistemology' contrasting 'Surface Epistemology' of the West.

Thrust Areas:

- Contemporary Epistemology
- Human Values & Virtues
- Applied Philosophy (Including Applied Ethics)
- Consciousness Studies
- Philosophy of Mind
- Philosophy of Religion

Programmes of Study:

S.N.	Programme of Study	Duration
1.	Ph.D	5 years(includes course work)
2.	M. A./M. Sc.	2 years/ 4 semesters
3.	B. A./B. Sc.	3 years

Faculty members and their Area of Research:

S.N.	Name	Gender	Designation	Area of Specialization
1.	Prof. H.S. Upadhyaya	Male	Professor	Modern Western Philosophy & Western Epistemology
2.	Prof. Debashis Guha	Male	Professor	Ethics, Philosophy of religion, Political philosophy
3.	Prof. Rishi Kant Pandey	Male	Professor	Contemporary Western Philosophy, Epistemology & Indian Philosophy
4.	Dr. Gopal Sahu	Male	Professor	Contemporary Epistemology, Philosophy of Mind & Logic
5.	Dr. Asha Lal	Female	Associate Professor	Western Philosophy & Logic
6.	Dr. K. Bhima Kumar	Male	Assistant Professor	Indian Philosophy & Social Philosophy
7.	Dr. Surya Kant Maharana	Male	Assistant Professor	Vedanta; Continental Philosophy; Logic

Support Staff:

Sl.N.	Name	Gender	Category	Designation	Work Assigned
1.	Shri Vipin Chandra Srivastava	Male	Gen	Junior Office Assistant	Clerical
2.	Shri Navin Chandra Joshi	Male	Gen	Junior Office Assistant	Clerical
3.	Shri Ram Nath	Male	SC	Peon	Peon
4.	Shri Hari Shankar Pandey	Male	Gen	Peon	Peon
5.	Shri Rakeeb Ahmad	Male	OBC	Peon	Peon
6.	Smt. Maya Devi	Female	SC	Sweeper	Sweeper
7.	Shri Dev Narayan	Male	Gen	Peon	Peon

Details of Students, Year wise and Reservation wise (2018-2019):

Course	Gen			OBC			SC			ST			PwD			TOTAL		
	Male	Female	Total	Male	Female	Total	Male	Female	Total	Male	Female	Total	Male	Female	Total	Male	Female	Total
Ph.D	01	02	03	-	02	02	01	-	01	-	-	-	-	-	-	02	04	06
PG	89	24	113	23	06	29	16	04	20	02	-	02	01	-	01	131	34	165
UG	657	276	933	209	98	307	190	61	251	04	-	04	05	-	05	1065	335	1500
Total	747	302	1049	232	106	338	207	65	272	06	-	06	06	-	06	1198	473	1671

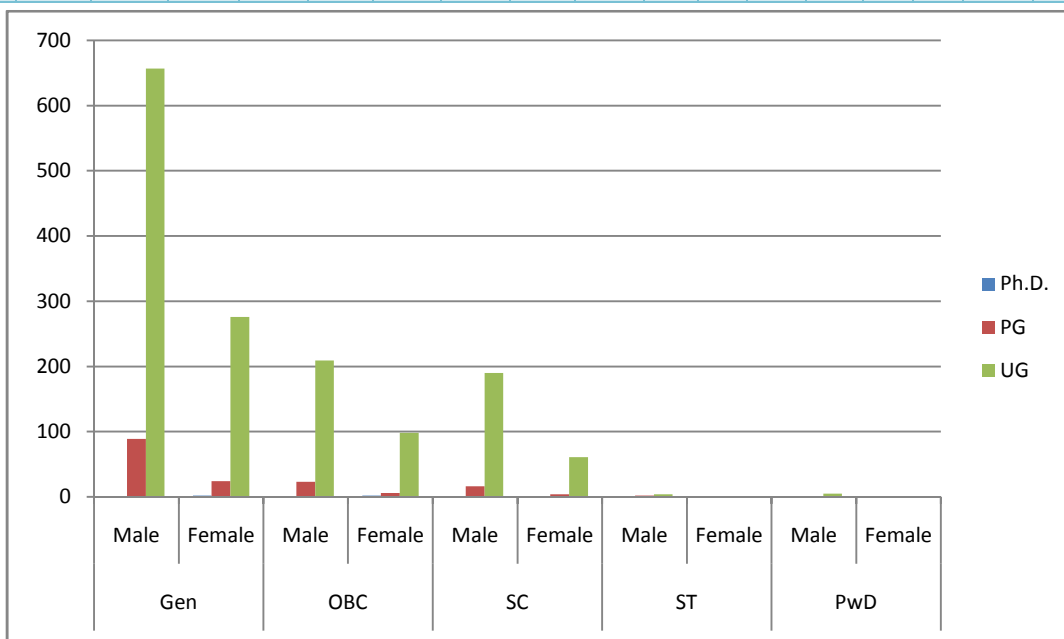

Student Enrollment for the Department

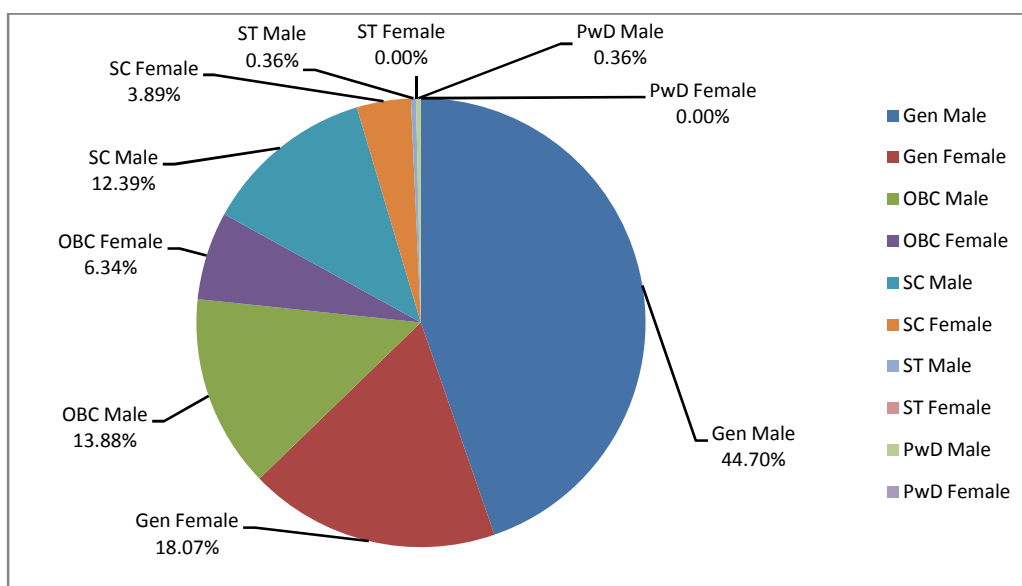

Gender wise distribution of Students

Seminars/Workshops/Conferences conducted by the Department/Centre:

S. No.	Name of the Seminar/workshop/conference	National / International	Duration and dates	Funding/sponsor Agenc(y/ies)	No. of Participants	No. of Papers presented
1.	34 TH Session of the Darshan Parishad	National	May 5-6, 2019	Indian Council of Philosophical Research, New Delhi	109	28

Academic Organizations (headquartered in the department):

S.No.	Name	Nature	Objectives
1.	Darshan Parishad	National	To disseminate philosophical Knowledge

Journals published by the Department/Centre:

S.No.	Title	Nature	Established	Frequency	ISSN
1.	SANDARSHAN	NATIONAL	1975	Annual	0975-0835

Proposed Courses

S. No.	Name of Programme	Nature	Duration	Proposed or In process	Intake of Students
1.	Philosophical Counseling	Course/Diploma	One Semester	In process	10
2.	Environmental Issues/Climate Change	Course/Diploma	One Semester	In process	10
3.	Application of Yoga in Life	Course/Diploma	One Semester	In process	10

Proposed Projects/SAP Grants etc.

S. No.	Type of Project/grant	Title/Name	Duration	Proposed amount	Proposed or In process	Remarks
1.	Centre for Advanced Study	CAS, Phase-II	Years	One Crore	In Process	Completed CAS-I in 2018

Outreach Activities:

S. N.	Name of Faculty Member/ Student/ Researcher	Title of the paper presented	Title of Conference/ Seminar etc	Duration of the Conference/ assignment	Organized by
1.	Gopal Sahu	Is Wittgenstein a Rule-Following Skeptic?	International Conference on "Doubt and Knowledge: Indian and Western Perspectives"	March 15-17, 2019	UGC-CAS, Department of Philosophy, University of Rajasthan, Jaipur
		Ethics in <i>Philosophical Investigations</i>	National Seminar on "Buddha and Wittgenstein on Culture and Values"	March 14-16, 2019	Centre for Mahayana Buddhist Studies, Acharya Nagarjuna University, Nagarjuna Nagar, Guntur, Andhra Pradesh.
		Naturalized Epistemology	Invited Talk	January 6, 2019	PG Department of Philosophy and Critical Study, UN (Auto) College of Science and Technology, Adaspur, Cuttack, Odisha
		Universal Religion and Religious Exclusivism: Vivekānanda's Copernican Revolution in Religion	National Seminar on "Unity of Religions: Mission of Swami Vivekānanda"	January 7, 2019	Department of Philosophy, Shailabala Women's (Autonomous) College, Cuttack, Odisha
2.	K.Bhima Kumar	Nyaya-Buddhist controversy on Perceptual cognition: Some Reflections.	Nyaya Theory of Cognition: Issues and Responses	9th -10th January, 2019.	UGC-SAP-DSA-III, Department of Philosophy, University of Hyderabad, Telangana.
		(Plenary Session) Nānyaḥ Panthā Vidyate ayanāya" (There is no other way to perfection (except Ādhyatmika Sādhanā)	Role of Jñāna, Karma and Bhakti in Ādhyatmika Sādhanā Leading to Perfection (Mokṣa)	25th -27th January, 2019	Indian Council of Philosophical research, at Shri Guru Karshni Kumbh Mela Shivir, Salori Govindpur Marg, Sector-7, Prayagraj.
		Ethics in the current	Faculty, Academic Parameters	10th -11th	Faculty Development Centre,

S. N.	Name of Faculty Member/ Student/ Researcher	Title of the paper presented	Title of Conference/ Seminar etc	Duration of the Conference/ assignment	Organized by
		context of Higher Education: Some Issues and Challenges	And Organizational Performance	March, 2019.	PMMMNMTT Scheme, Ministry of HRD, Govt of India at Iswar Saran PG College, University of Allahabad, Prayagraj, Uttar Pradesh.
		The Philosophical Foundations of Buddhist Economics: Some Reflections	Buddha and Wittgenstein on Culture and Values	14th -16th March, 2019.	Centre for Mahayana Buddhist Studies, Acharya Nagarjuna University, Nagarjuna Nagar, Guntur, Andhra Pradesh.
		10 Days Workshop	Textual Study of Kathavattu	5th -14th September, 2018.	Indian Council of Philosophical Research Academic Centre, Lucknow, Uttar Pradesh.
		7 Days Workshop	Academic Writing In Humanities And Social Sciences	23rd -1st March, 2019.	Under the Scheme of Pandit Madan Mohan Malviya National Mission on Teachers and Teaching (PMMMNMTT), Ministry of HRD, Government of India, at Iswar Saran PG college, University of Allahabad, Prayagraj, U.P
3.	Surya Kant Maharana	The Being of Self: An Exploration in the Philosophies of Buddha and Wittgenstein	UGC Sponsored Inter-disciplinary National Seminar on 'Buddha and Wittgenstein on Culture and Values'	March 14-16, 2019.	Centre for Mahayana Buddhist Studies, Acharya Nagarjuna University, Guntur, Andhra Pradesh,
		Professional Ethics: An Upanisadic Perspective	ICPR Sponsored National Seminar on 'Indian Ethics: Its Relevance in Present Times	April 6-7, 2019	PG Department of Philosophy, Vikram Dev Autonomous College, Jeypore, Odisha.
		Outcome-Based Education: Perspectives from Ancient Indian Wisdom	Faculty Development Program (FDP) on 'Outcome-Based Education'	September 5-9, 2018	Biju Pattnaik University of Technology (BPUT), Bhubaneswar,
		Models to Approach Phenomenology	Special Lecture	February 20, 2019	Special Lecture Series of the Department of Philosophy, Ravenshaw University, Cuttack, Odisha
		One Day Training Programme on 'Human Rights'	Sponsored by National Human Rights Commission, New Delhi,	November 16, 2018.	Iswar Sharan PG College, University of Allahabad
		Training-cum-Workshop on 'Research Methodology for Humanities and Social Sciences	Under the Scheme of Pandit Madan Mohan Malviya National Mission on Teachers and Teaching (PMMMNMTT), Ministry of HRD, Government of India	January 7-22, 2019	Iswar Saran PG college, University of Allahabad, Prayagraj
		-	ICPR Sponsored Two Days National Seminar on 'Jnana, Karma and Bhakti'	January 22-24, 2019	Indian Council of Philosophical Research, New Delhi

DEPARTMENT OF PHYSICAL EDUCATION

Introduction:

The Department of Physical Education of the University of Allahabad was founded in 27th November 1987 under the faculty of arts. Functioning started with admission in the Bachelor of Physical Education (Three Years Degree Course.) of first batch from 15 March 2000. The Department has introduced M.P.Ed (Two Years Post Graduate Course) course in academic session 2015-16 with an intake of 40 seats as per the guidelines of the National Council of Teacher Education (N.C.T.E.). Department is also offering research programme Ph.D. Course to foster the academic furtherance and research excellence in the frontier areas of physical education and sports sciences. Presently Prof. D.C. Lal serving as Head of the Department.

Programmes of Study:

S.No.	Programme of Study	Duration	No. of Seats
1.	Ph.D.	5 years (includes course work)	4
2.	M. A./M. Sc./M.P.ED	2 years	40
3.	B. A./B. Sc./B.P.E.	3 years	30

Faculty members and their Area of Research:

S.No.	Name of Faculty	Designation
1.	Dr. Archana Chahal	Professor
2.	Dr. D.C. Lal	Professor & Head

Support Staff:

S.No.	Name	Gender	Category	Designation
1.	Mr. Jitesh Kumar	Male	O.B.C.	Jr. Office Assistant
2.	Mr. Santosh Sahay	Male	Gen	Office Assistant
3.	Mr. Gyan Singh Yadav	Male	O.B.C.	Peon
4.	Mr. Kailash Yadav	Male	O.B.C.	Peon

Details of Students, Year wise and Reservation wise (2018-2019):

Course	Gen			OBC			SC			ST			PwD			TOTAL		
	Male	Female	Total	Male	Female	Total	Male	Female	Total	Male	Female	Total	Male	Female	Total	Male	Female	Total
Ph.D.	03	01	04	02	-	02	02	-	02	-	-	-	-	-	-	-	-	08
PG/M.P. Ed	18	03	21	24	05	39	10	03	13	-	-	-	-	-	-	-	-	73
UG/B.P.E.	08	01	09	09	02	11	08	-	08	-	-	-	-	-	-	-	-	28

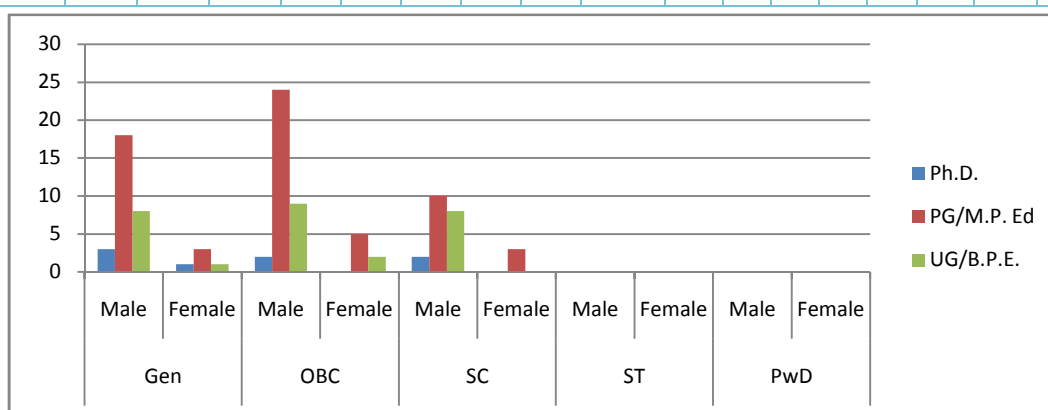

Student Enrollment for the Department

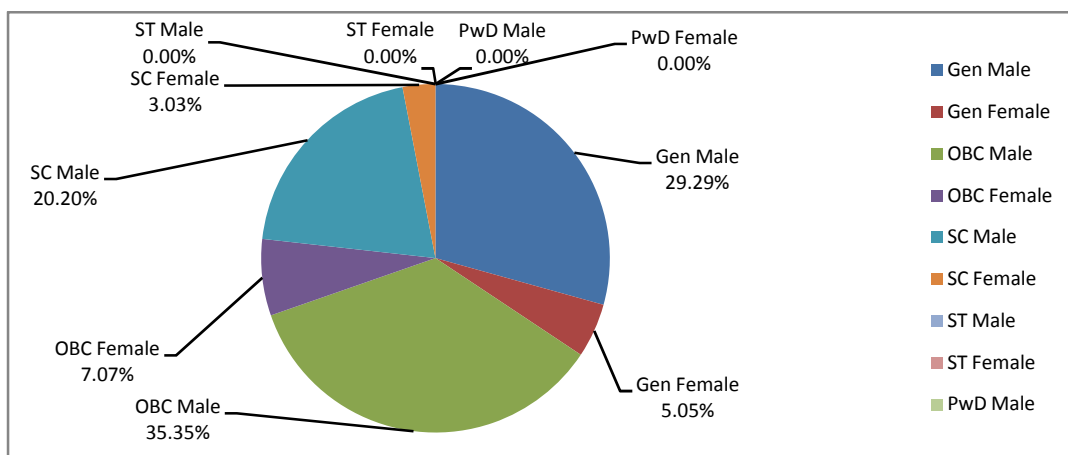

Gender wise distribution of Students

Seminars/Workshops/Conferences conducted by the Department/Centre:

S. No.	Name of the Seminar/ workshop/conference	National / International	Duration and dates	Funding/sponsor Agenc(y/ies)	No. of Participants
1.	Wokshop	National	One day 15.05.2018	NADAE Ministry of Sports New Delhi	200

Outreach activities:

S.N.	Name of Faculty Member/Student/ Researcher	Title of the paper presented	Title of Conference/ Seminar etc	Duration of the conference/ assignment	Organized by
1.	Prof. Archana Chahal	04 Health Fitness & Lifestyle	Invited Lecture in HRDC		HRDC

DEPARTMENT OF POLITICAL SCIENCE

Introduction:

The Department of Political Science of this University began functioning in 1927, has a glorious past, was headed by eminent historians like Dr. Beni Prasad, Prof. Ishwari Prasad and Dr. Tara Chand and reputed political scientists like Prof. A. B. Lal, and A. D. Pant.

The Department gained recognition for its academic excellence and remarkable achievements of its students especially in the Civil Service Examinations. Eminent bureaucrats playing a significant role at national and state levels have been students of this department. The department has also produced a large numbers of JRFs and NET scholars – clearly establishing the high quality of teaching and research. In fact, it has gained recognition as a leading centre of knowledge and research in North India.

Thrust Areas:

The Department is imparting thrust to research-oriented teaching. The Department is having Optional Papers at the M.A. level, keeping in view the changing dimensions of the subject. Some of the new papers are : Green Political thought, South Asian Political System, Political Sociology, Human Rights, State Politics in India with special reference to U.P., Feminist Theory, Politics, Culture and Mass Media, International Law and Research Methodology.

Keeping in view the increasing importance of International relations and security studies, the Department is having an optional paper exclusively on *International Relations and Security Studies*. The optional papers are: International Relations, South Asian Regional Security, Foreign Policy of Major Powers, and India in World Affairs.

Programmes of Study

S.No.	Programme of Study	Duration	No. of Seats
1.	Ph.D.	5 years (includes course work)	23 (Differs year to year)
2.	M. A./M. Sc.	2 years (4 semester)	116 (Previous), 87 (Final)
3.	B. A./B. Sc.		1124+714+681

Faculty members and their Area of Research:

S. No.	Name of Faculty	Gender	Designation	Area of Specialization
1.	Dr. Anuradha Agrawal	Female	Professor	<i>Political Sociology; Indian Political Thought and Feminist Theory</i>
2.	Dr. D.D. Kaushik	Male	Professor	<i>International Relations; Indian Foreign Policy</i>
3.	Dr. H.K. Sharma	Male	Professor	<i>International Relations; Human Rights</i>
4.	Dr. Kartikeya Misra	Male	R.A.with Lecturer Grade	<i>Comparative Politics; Western Political Thought Concepts and Theories</i>
5.	Dr. M.F.U. Kazmi	Male	Professor	<i>Western Political Thought; Human Rights; Contemporary Indian Politics; Interface between Politics, Society and Culture; Film Theorist</i>
6.	Dr. Mohammad Shahid	Male	Professor	<i>South Asian Political System; International Politics; Muslim Political Thought; Islamic Diaspora In the World.</i>
7.	Dr. Pankaj Kumar	Male	Professor	<i>Indian Political System; Indian Administration</i>
8.	Dr. Rajpal Budania	Male	Professor	South Asian regional security, particularly India's national security and defence policies, and relations with Pakistan; International Relations
9.	Dr. V.K. Rai	Male	Professor	<i>Gandhian Thought; Public Policy; Panchayati Raj and Local Self Government; Public Administration.</i>

Support Staff:

S. No.	Name	Gender	Category	Designation	Work assigned
1.	Satish Chandra	Male	SC	Senior Assistant	All Office work with Computer, Accounts, RTI and Correspondence with other Departments
2.	Mr.Santosh Kr. Srivastava	Male	GEN	Junior Office Assistant	Office Work with Computer, Admission, Examination, Research and BOS work and Library.
3.	Mr.Ashok Kumar	Male	SC	Peon	Looking after various needs of Department
4.	Mr. Mohammad Anis	Male	OBC	Peon	Looking after various needs of Department
5.	Mrs. Rajwanti Devi	Female	SC	Peon	Looking after various needs of Department
6.	Mr. Nirmal Kumar Singh	Male	GEN	MTS	Looking after various needs of Department

Details of Students, Year wise and Reservation wise (2018-2019):

Course	Gen			OBC			SC			ST			PwD			TOTAL		
	Male	Female	Total	Male	Female	Total	Male	Female	Total	Male	Female	Total	Male	Female	Total	Male	Female	Total
Ph.D.	6	6	12	05	01	06	04	01	05	00	00	00	01	0	01	15	08	23
PG	45	09	54	84	08	92	42	03	45	07	00	07	05	00	05	183	20	203
UG	661	133	794	944	139	1073	465	77	542	75	13	88	10	05	15	2155	367	2522
Total	712	148	860	1033	148	1171	511	81	592	82	13	95	16	21	21	5323	395	2748

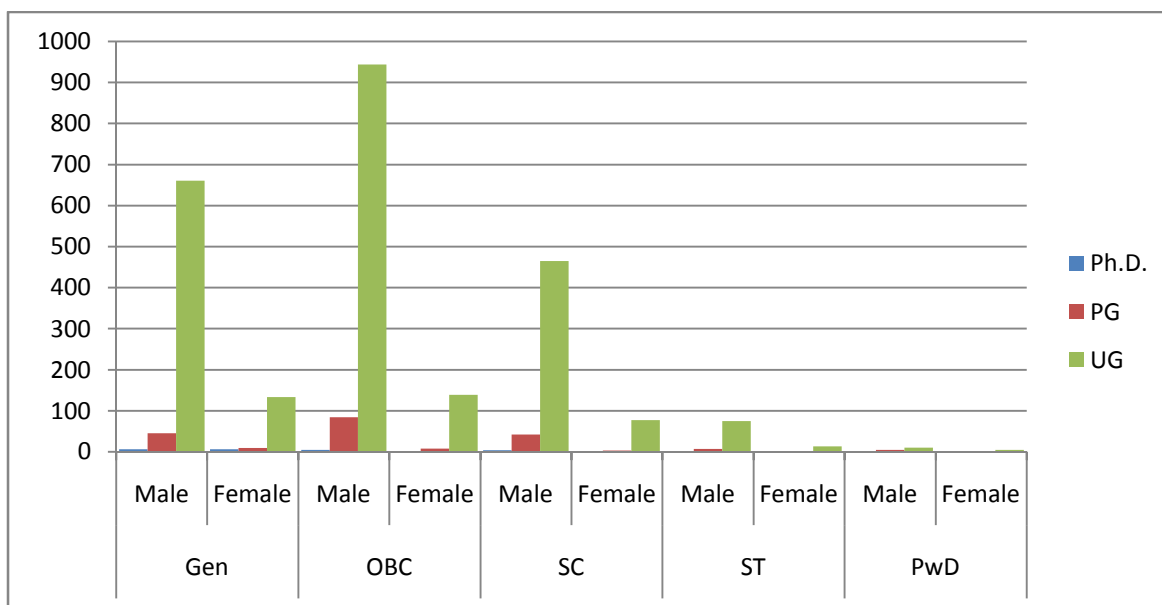

Student Enrollment for the Department

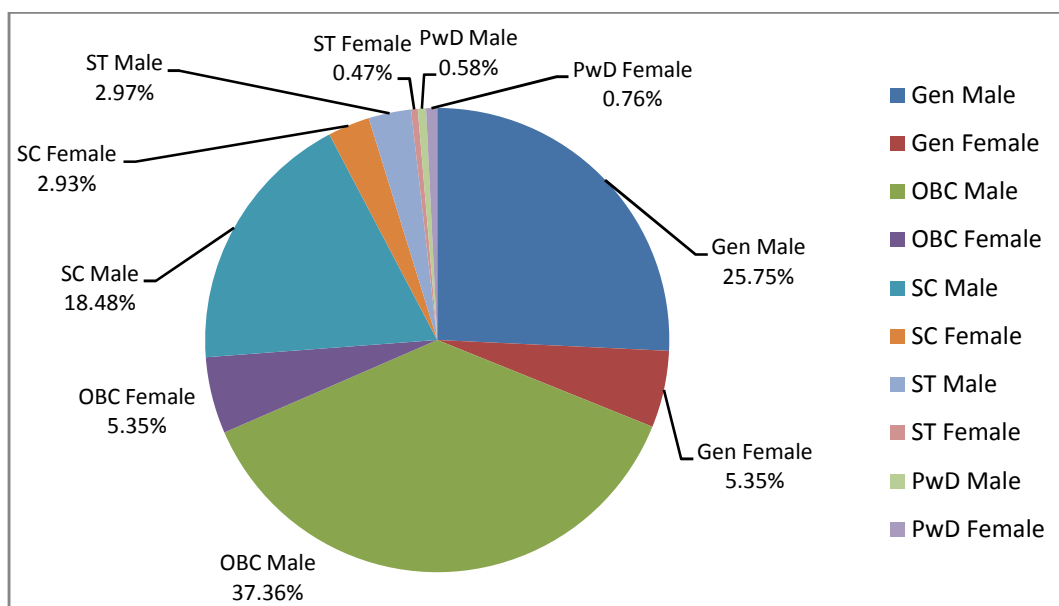

Gender wise distribution of Students

Seminars/Workshops/Conferences conducted by the Department/Centre:

S. No.	Name of the Seminar/workshop/conference	National / International	Duration and dates	Funding/ sponsor Agenc (y/ies)	No. of Participants	No. of Papers presented
1.	Emerging Trends of Indian Politics : Issues, Challenges and Possibilities	National	Two Days 30-31 March,, 2019	ICSSR	150	90

Awards/Honours/Fellowship received:

S.N.	Name of Faculty Member/ Student who received award	Name of the award	Organization conferring award
1.	Prof. V.K. Rai	Best Teacher Award	University of Allahabad
2.	Prof. H.K. Sharma	Contribution for Education	Rastriya Nirbhaya Sena
3.	Prof. H.K. Sharma	Creating Awareness for rights of Women	Droit Penal Foundation, Allahabad
4.	Anam Mobin	Merit Certificate	University of Allahabad
5.	Alka Pandey	Merit Certificate	University of Allahabad
6.	Pratima Singh	Merit Certificate	University of Allahabad

Other Projections :

- New schools like School of Development Studies, Gender Studies, International Studies, Behavioral Studies, Legal Studies & Human Rights, Environmental Studies may be started.
- Department of Political Science is trying to make learning participative, interactive and learner centric. We provide the training ground to our future leaders and citizens so that they are able to play an effective role in the process of nation building.

Outreach activities

S. N.	Name of Faculty Member/Student/ Researcher	Title of the paper presented	Title of Conference/ Seminar etc	Duration of the assignment	Organized by
1.	Prof. Rajpal Budania	Globalisation and its consequences	UGC 7 th Summer School in Social Sciences	5 July , 2018	UGC Human Resource Development Centre, UoA

S. N.	Name of Faculty Member/Student/Researcher	Title of the paper presented	Title of Conference/Seminar etc	Duration of the assignment	Organized by
		Limits of Multilateralism in South Asia : India's Approach and Role'	Bilateral and Multilateral Matrix in South Asia	5-6 February, 2019	UNESCO Madanjeet Singh Institute of South Asia Regional Cooperation and Centre for South Asian Studies, Puducherry
		Chaired the Plenary Session	Caste, Democratic Politics and Nation-Building: Issues, Challenges and Possibilities	21-22 February, 2019	Department of Political Science, Iswar Saran Post Graduate College; UoA
		Recent Developments in Pakistan-Occupied Jammu and Kashmir	Recent Developments in Pakistan-Occupied Jammu and Kashmir	19, March, 2019	Indian Council of World Affairs
		India's National Interests and Multilateralism as a Strategy	India's Foreign Policy: Continuity and Change under PM Modi	29-30 March, 2019	Guru Nanak Dev University, Amritsar
2.	Prof. Anuradha Agarwal		Caste, Democratic Politics and Nation-Building: Issues, Challenges and Possibilities	21-22 February, 2019	Department of Political Science, Iswar Saran Post Graduate College; UoA
		Women and Politics in India	International Women's Day Lecture	8 March, 2019	Women' College, University of Allahabad.
		Chaired a Session	National Seminar on Emerging Trends of Indian Politics: Issues, Challenges and Possibilities	30-31 March 2019	Institute of Gandhian Thought and Peace Studies & Department of Political Science, UoA
3.	Prof. V.K. Rai	Keynote Address	National Seminar on Caste, Democratic Politics and Nation Building: Issues, Challenges and Possibilities	21-22 February, 2019	Department of Political Science, Iswar Saran Post Graduate College; UoA
		Welcome and Introductory Address	National Seminar on Emerging Trends of Indian Politics: Issues, Challenges and Possibilities	30-31 March 2019	Institute of Gandhian Thought and Peace Studies & Department of Political Science, UoA
4.	Prof. H.K. Sharma	Chaired a Session	National Seminar on Caste, Democratic Politics and Nation Building: Issues, Challenges and Possibilities	21-22 February, 2019	Department of Political Science, Iswar Saran Post Graduate College; UoA
5.		Chaired a Session	National Seminar on Emerging Trends of Indian Politics: Issues, Challenges and Possibilities	30-31 March 2019	Institute of Gandhian Thought and Peace Studies & Department of Political Science, UoA
		Filipino Muslims's Contribution in Constructing the peaceful Image of Islam in Southeast Asia	Islam in Philippines : Opportunities and Prospects	Phillipines 5-7 May., 2018	Philippines Muslim Association, Manila
		Revival of Turkish philanthropist Work in the neighbourhood	National Annual Conference	Albania 27-29 July, 2018	Albania Muslim Association, Tirana, Albania
		Contribution of Somalians in the state of Minnesota	Somalians in USA	USA Minneapolis, 16-17 October, 2018	Confederation of Somali Community in Minnesota (CSCM)
		Responsibilities of Faith Organisations	Message of Peace to Humanity	USA New Jersey, 26-28 October, 2018	Al-Minhaal Academy, 1764 New Durham Road, South Plainfield, NJ 07080 United States
		Islam and Globalisation	Annual Conference	Dallas, 5-7, October, 2018	Islamic Association of Arabi, 1601 W. Campbell Dr, Garland, TX. 75044 (USA)
		Importance of Education in the Quran	Role of the Quran in building Humanity	Houston, 2-3 , October, 2018	ISLAMIC EDUCATION INSTITUTE, 19214 Clay Rd Ste Katy, TX 77449
		Syrian Refugees and Turkish Welfare Policies	Role of Philanthropists for Refugees	Sanli Urfa, Turkey 16-18 November, 2018	Ilim Ve Hayrat Vakfi, Istanbul
		Importance of Human Rights in Islam	Islam and Human Rights	January 4-6, 2019 in Liberia	The National Muslim Council, Monrovia, Liberia

S. N.	Name of Faculty Member/Student/Researcher	Title of the paper presented	Title of Conference/Seminar etc	Duration of the assignment	Organized by
		Rights of Women in Islam	Islam and Human Rights	January 11-13, 2019	Islamic Choura Human Rights Association, Nango Markaze Commune Ratoma- Guinea Conakry
7.	Tiwari, Satyam	The Role of Social Media Platforms in the Indian Electoral Process : A New Battleground	National Seminar on Emerging Trends of Indian Politics: Issues, Challenges and Possibilities	30-31 March 2019	Institute of Gandhian Thought and Peace Studies & Department of Political Science, UoA
	Saurabh, Kumar	भारतीय लोकतंत्र एवं जातिवादी राजनीति	National Seminar on Caste, Democratic Politics and Nation Building: Issues, Challenges and Possibilities	21-22 February, 2019	Department of Political Science, Iswar Saran Post Graduate College; UoA
	Saurabh, Kumar	पंचायती राज व्यवस्था एवं सामाजिक न्याय का बदलता स्वरूप	International Seminar on Social Justice and Development: Challenges and Opportunities in Vibrant Democracies	23-24 February, 2019	Department of Political Science, D.D.U. Government PG College; Saidabad Prayagraj
	Saurabh, Kumar	भारतीय लोकतंत्र एवं 'फर्स्ट पास्ट द पोस्ट' चुनाव प्रणाली: किस हद तक समावेशी	National Seminar on Emerging Trends of Indian Politics: Issues, Challenges and Possibilities	30-31 March 2019	Institute of Gandhian Thought and Peace Studies & Department of Political Science, University of Allahabad
8.	Gupta, Neha	The Changing Pattern of Health Sector in India : Challenges and Concerns of Women's Reproductive Rights	National Seminar on Emerging Trends of Indian Politics: Issues, Challenges and Possibilities	30-31 March 2019	Institute of Gandhian Thought and Peace Studies & Department of Political Science, UoA
9.	Pratima Singh	जतियों का राजनीतिकरण एवं पंचायतीराज व्यवस्था	National Seminar on Caste, Democratic Politics and Nation Building: Issues, Challenges and Possibilities	21-22 February, 2019	Department of Political Science, Iswar Saran Post Graduate College; UoA
		भारत में 21वीं सदी में सामाजिक न्याय का बदलता स्वरूप	International Seminar on Social Justice and Development: Challenges and Opportunities in Vibrant Democracies	23-24 February, 2019	Department of Political Science, D.D.U. Government PG College; Saidabad Prayagraj
		भारतीय राजनीति में महिलाओं की बराबर की भागीदारी	National Seminar on Emerging Trends of Indian Politics: Issues, Challenges and Possibilities	30-31 March 2019	Institute of Gandhian Thought and Peace Studies & Department of Political Science, University of Allahabad

DEPARTMENT OF PSYCHOLOGY

Introduction:

The Department of Psychology at Allahabad University was established in 1961 with Prof. Durganand Sinha as the first chairperson and two other faculty members. In 1977, the UGC approved it as a Department of Special Assistance (DSA) and the faculty strength was increased to 20. In recognition of its outstanding contribution to the field of Psychology in India, the Department was upgraded as the centre for Advanced Studies (CAS) in 1984 by the UGC. The Department was evaluated by the UGC and second, third and fourth terms of CAS were sanctioned between the period 1989 to 2008.

In 1989, the Department started an international journal 'Psychology and Developing Societies' in collaboration with the Sage publications which is now in its 31st year. The Department was the first in the University to start Ph.D. with course work as early as in 1979. Semester system in P.G. Programme was started in the Department in 1989 and later on, in 2001, the Department adopted 'Choice Based Credit System' in P.G. Programme. The Department has Departmental Library which is recognized as regional resource center.

Thrust Areas:

The faculty research scholars conduct research in the following thrust areas:

- Clinical Psychology & Mental Health
- Organizational Behaviour
- Social Psychology
- Cognitive Psychology
- Health Psychology
- Women, Family & Child Development

Programmes of Study:

S. No.	Programme of Study	Duration	No. of Seats	Specialization(s)
1.	Ph.D.	5 years (includes course work)	06 for 2018-19	Please see thrust areas mentioned in Item No. 2
2.	M. A./M. Sc.	2 Year (Semester- System)	45	M. A./M. Sc. In Psychology
3.	B. A./B. Sc.	3 Year	Total 300 students enrolled	--

Faculty members and their Area of Research:

S. No.	Name of Faculty	Gender	Designation	Area of Specialization
1.	Dr. Komilla Thapa	Female	Professor & Head	Clinical and Counselling Psychology
2.	Dr. Namita Pande	Female	Professor	Cognitive Psychology, Indigenous Psychology, Stress, Health and Rehabilitation
3.	Dr. Neena Kohli	Female	Professor	Health Psychology and Organizational Behaviour
4.	Dr. Rashmi Kumar	Female	Professor	Social Psychology and Organizational Behaviour
5.	Dr. Ritu Modi	Female	Assistant Professor	Mental Health
.	Dr. Shanti Suman	Male	Assistant Professor	Organizational Behaviour and Cognitive Neuropsychology

Support Staff:

S.No.	Name	Gender	Category	Designation/Work
1.	Syed Raza Hasnain Rizvi	Male	GEN	Office Assistant
2.	Vachaspati Shukla	Male	GEN	Sr. Technical Assistant
3.	Shahida Haider	Female	GEN	Library Assistant
4.	Hari Ram	Male	OBC	Lab. Attendant
5.	Deo Narain	Male	OBC	Peon
6.	Km. Deep Mala	Female	SC	Peon
7.	Smt. Prema Devi	Female	OBC	Peon

S.No.	Name	Gender	Category	Designation/Work
8.	Deepak Kumar	Male	SC	Peon
9.	Pradeep Kumar	Male	SC	Peon

Details of Students, Year wise and Reservation wise (2018-2019):

Course	Gen			OBC			SC			ST			PwD			TOTAL		
	Male	Female	Total	Male	Female	Total	Male	Female	Total	Male	Female	Total	Male	Female	Total	Male	Female	Total
Ph.D.	03	0	03	0	02	02	01	0	01	0	0	0	-	-	-	04	02	06
PG	09	27	36	08	11	19	03	05	08	01	01	02	-	-	-	21	44	65
UG	56	54	110	98	33	131	39	16	55	04	0	04	-	-	-	197	103	300
Total	68	81	149	106	46	152	43	21	64	05	01	06	-	-	-	222	59	371

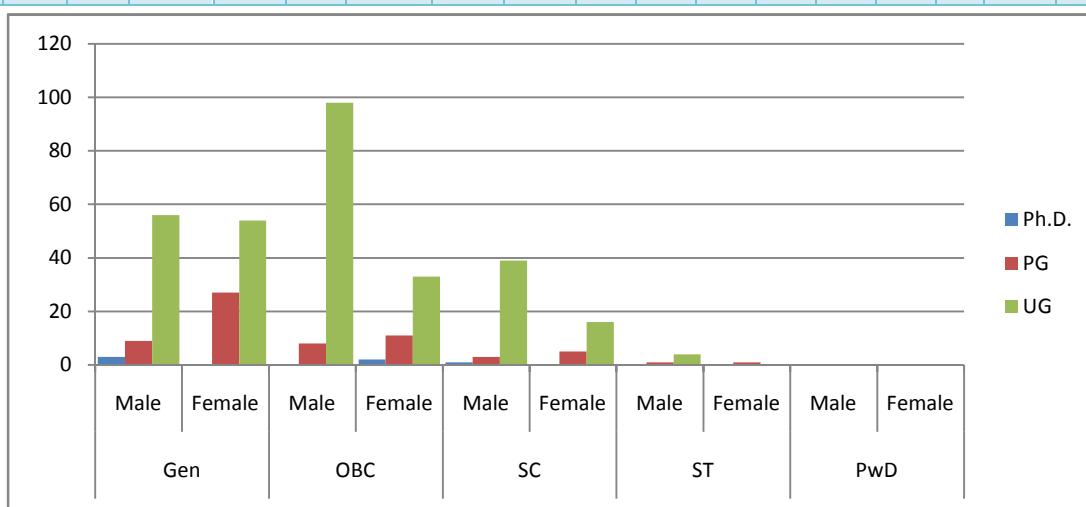

Student Enrollment for the Department

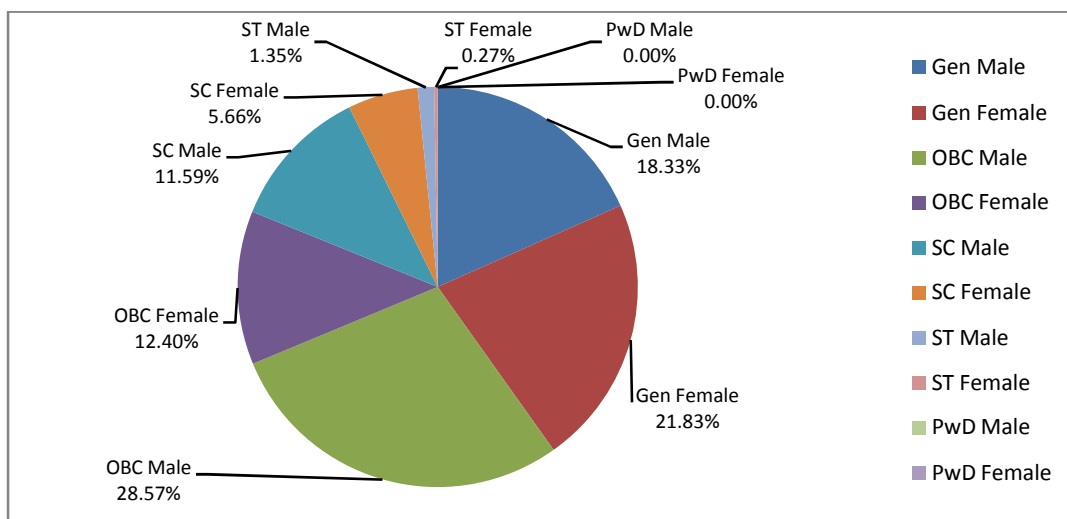

Gender wise distribution of Students

Seminars/Workshops/Conferences conducted by the Department/Centre:

S. No.	Name of the Seminar/ workshop/conference	National / International	Duration and dates
1.	Workshop on 'Publishing and Peer Review of Research Articles' by Prof. Jyotsna Kalavar, Georgia University, Atlanta (USA).	National	One Day; December 16, 2018

Training/orientation/refresher courses/special lectures conducted by the Department/Centre:

S. No.	Name of the course	Duration and dates	Funding/ sponsor	Speakers
1.	Special lecture on 'The art and the science of killing' on the occasion of 58 th Foundation Day of the department.	September 24, 2018	University of Allahabad	Prof. Ashis Nandy
2.	Special lecture	January 8, 2019		Prof. Rashmi Gupta, School of Social Work, San Francisco State University (USA)

Journals published by the Department/Centre:

S.No.	Title	Nature	Established	Annual/bi-annual / quarterly	ISSN
1.	Psychology and Developing Societies	International	1989	Biannual	0971-3336

Outreach activities:

S. N.	Name of Faculty Member/ Student/ Researcher	Title of the paper presented	Title of Conference/ Seminar etc	Duration of the assignment	Organized by
1.	Aditi Pande	"Do cognitive styles influence categorization of Objects, Faces, and People?"	28th Annual Convention of National Academy of Psychology (NAOP 2018) & International Conference on 'Towards Building Inclusive Societies'	December 19-21, 2018	Department of Applied Psychology, Ramanujan College, University of Delhi.
2.	Aditi Pande		Seven days' Workshop on 'Qualitative research methods in Social Sciences'	June 11-17, 2018	Department of Humanities & Social Sciences, MNNIT Allahabad.
3.	Chhavi Gupta	Role Of Social Media Engagement Style And Social Comparison In Relationship Between Social Media Usage And Subjective Well-Being	54th National and 23rd International Conference of Indian Academy of Applied Psychology (Psychology: Opportunities Beyond Boundaries)	14th-16th February, 2019	Department of Psychology, Kurukshetra University, Kurukshetra, Haryana.
4.	Divya Rani	Determinants and Consequences of Obesity	54th National and 23rd International Conference of Indian Academy of Applied Psychology (Psychology: Opportunities Beyond Boundaries)	14th-16th February, 2019	Department of Psychology, Kurukshetra University, Kurukshetra, Haryana.
5.	Kirti Srivastava	"But..I deserve it: Reservation System in India and its Psychosocial Consequences"	XXVIII Annual Convention of National Academy of Psychology (NAOP 2018) & International Conferences on 'Towards Building Inclusive Societies'	December 19-21, 2018.	Department of Applied Psychology, Ramanujan College, University of Delhi.
6.	Kirti Srivastava		Seven days' workshop on 'Qualitative research methods in Social Sciences'	June 11-17, 2018	Department of Humanities and Social Sciences, MNNIT Allahabad

S. N.	Name of Faculty Member/ Student/ Researcher	Title of the paper presented	Title of Conference/ Seminar etc	Duration of the assignment	Organized by
7.	Madhu Gautam		<i>Seven days' Workshop</i> on 'Qualitative research methods in Social Sciences'	June 11-17, 2018	Department of Humanities & Social Sciences, MNNIT Allahabad.
8.	Madhu Gautam	Presented a review paper entitled "psycho-social factors of depression in young adults"	28th Annual Convention of National Academy of Psychology (NAOP 2018) & International Conference on 'Towards Building Inclusive Societies'	December 19-21, 2018	Department of Applied Psychology, Ramanujan College, University of Delhi.
9.	Payal Kapoor		Seven days' Workshop on 'Qualitative Research Methods in Social Sciences'	11th to 17th June , 2018	Department of Humanities and Social Sciences, MNNIT, Allahabad.
10.	Payal Kapoor	Beneath the complexities of Emotional Labour: An Integrative Explanation	3rd National Conference on Recent Advances in Cognition and Health.	March 5-6, 2019.	Department of Psychology, Banaras Hindu University, Varanasi.
11.	Ragini Bahadur		Seven days' Workshop on Qualitative research methods in Social Sciences.	June 11-17, 2018	Department of Humanities & Social Sciences, MNNIT Allahabad.
12.	Ritu Modi	The Influence of Forgiveness and Gratitude on Subjective Well-Being	54th National and 23rd International Conference of Indian Academy of Applied Psychology (Psychology: Opportunities Beyond Boundaries)	14th-16th February, 2019	Department of Psychology, Kurukshetra University, Kurukshetra, Haryana.
13.	Shanti Suman	Invited Lectures	P.G. Diploma in Psychological Counselling	22 Oct - 05 Nov 2019	Institute of Distance Education, Dr. Harisingh Gour Vishwavidyalaya, Sagar (MP)
14.	Vandana Sharma	Psychosocial aspects of Inclusion: A Qualitative Study on Physical Disability Policies of India	XXVIII Annual Convention of National Academy of Psychology (NAOP 2018) & International Conference on 'Towards Building Inclusive Societies'	December 19-21, 2018	Department of Applied Psychology, Ramanujan College, University of Delhi.

DEPARTMENT OF SANSKRIT, PALI, PRAKRIT AND ORIENTAL LANGUAGES

Introduction:

This is one of the oldest and largest department of University of Allahabad. Sanskrit department came into existence in 1873 A.D. as a department of Muir Central College under aegis of Calcutta University. It was established 14 years earlier than A.U. (1887). Founder Head of this department was Prof. Adityaram Bhattacharya 1873-1902.

Thrust Areas:

Research thrust area of Sanskrit Dept. has been divided in three main streams- veda and vedic studies, Classical literature and Indian Philosophy.

Programmes of Study:

S. No.	Programme of Study	Duration	No. of Seats	Specialization(s)
1.	Ph.D.	5 years (includes course work)	--	--
2.	M. A.	Four Semester (CBCS)	168	Literature, Philosophy, Vedic Studies
3.	B. A.	Three Year	570	Not Required

Faculty members and their Area of Research:

S.N.	Name of Faculty	Gender	Designation	Area of Specialization
1.	Dr. Kaushal Kishore Srivastava	Male	Professor	Monism
2.	Dr. SuchitraMitra	Female	Professor	Vedic Studies
3.	Dr. UmakantYadav	Male	Professor	Vedic Philosophy
4.	Dr. Ram SewakDube	Male	Professor	Advaita Vedanta Philosophy

Support Staff:

S No.	Name	Gender	Category	Designation
1.	Ratan Kumar Sharma	Male	GEN	Office Assistant
2.	Dileep	Male	SC	Junior Office Assistant
3.	Gappu	Male	OBC	Peon
4.	Om Prakash Tiwari	Male	GEN	Peon

Details of Students, Year wise and Reservation wise (2018-2019):

Course	Gen			OBC			SC			ST			PwD			TOTAL		
	Male	Female	Total	Male	Female	Total	Male	Female	Total	Male	Female	Total	Male	Female	Total	Male	Female	Total
Ph.D.	32	20	52	13	19	32	06	06	12	0	0	00	00	00	00	51	45	96
PG	60	41	101	35	42	77	22	23	45	1	0	01	00	00	00	104	99	224
UG	89	49	138	265	104	369	83	26	109	0	2	02	00	00	00	437	181	628
Total	181	110	291	313	165	478	111	55	166	1	2	03	00	00	00	592	325	948

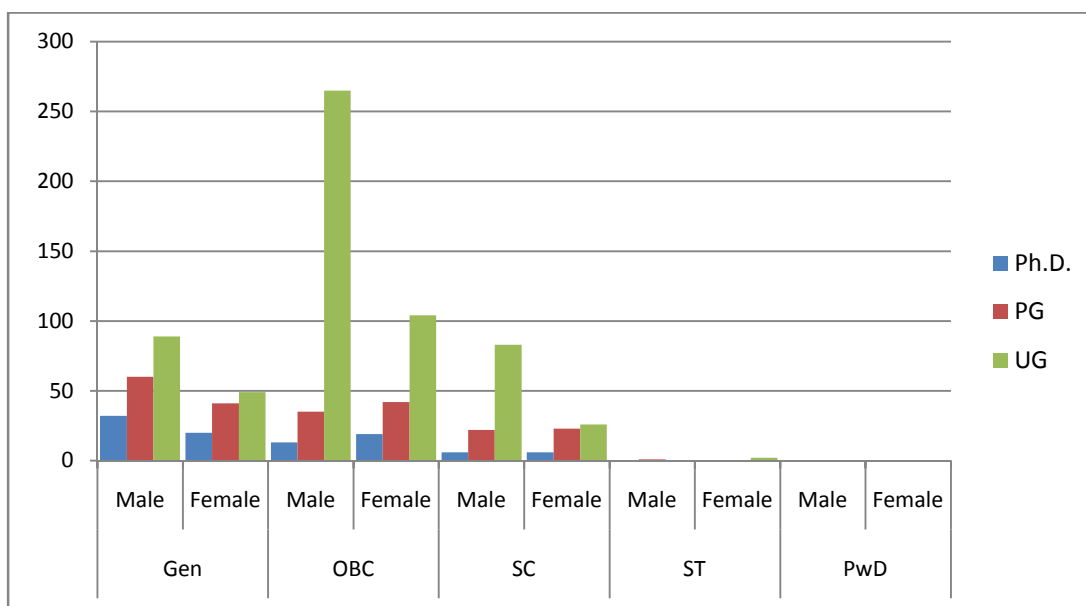

Student Enrollment for the Department

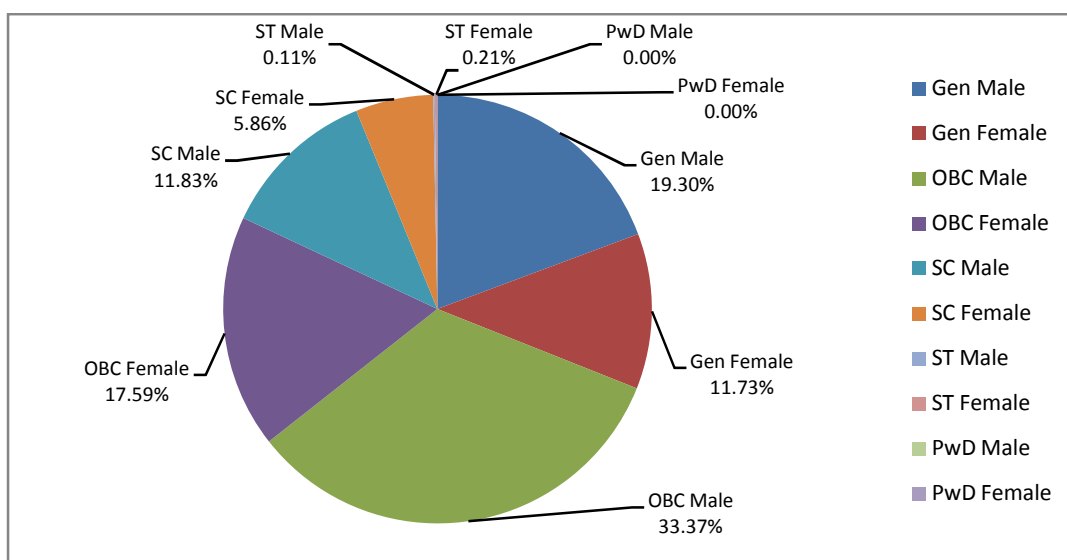

Gender wise distribution of Students

Seminars/Workshops/Conferences conducted by the Department/Centre:

S. No.	Name of the Seminar/workshop/conference	National / International	Duration and dates	Funding/sponsor Agenc(y/ies)	No. of Participants	No. of Papers presented
1.	Srimadbhagavadgita ke Vividha Ayam	National	2 Days 5-6 May, 2018	Pt. Ganga Nath Jha Chair	224	224
2.	Sanskrit Vanmayamein Sri Krishna Vimarsh	International	3 Days, 22-24 Feb. 2019	Pt. Ganga Nath Jha Chair	228	228

DEPARTMENT OF SOCIOLOGY

Introduction:

The department of Sociology started in June 2010. The main research thrusts of department are: Agrarian studies, Development studies, social movements, Subaltern studies and Sociology of Health and illness. So far, the Department has organized **03** Symposium/Workshop, **02** National Seminar/Symposium, **01** UGC sponsored Refresher Program, **02** Pre-Ph.D. Programme, **14** Public Lectures and **04** Consultancy Programme.

In the M.A. I semester, the students do conduct field studies individually in their place of residence relating to religious ceremonies and analyze the data in order to write reports. M.A. III semester students conduct library exercise to understand the issues of modernization and development of India in a comparative framework with selected African nations from secondary resources. Field study was conducted by the M.A. II semester students in the city of Allahabad on the broader theme of 'Youth' as a category. The sub-themes are: Youth and Education; Youth and Gender; Youth and ICT (Information Communication Technology); Youth and Politics; Youth and Religion. Similarly, M.A. IVth semester in-depth case studies among patients admitted to or visiting the hospitals in and around the Allahabad city. The major sub-themes include: The socio-economic profile of the households/patients; Folk wisdom on health and illness; Health programs and evaluation in rural/urban areas; Challenges of effective health care system in rural/urban areas; Maternal and child health – promise and realities; Doctor patient relationship – people's doctor and professional distance; Accessibility, affordability and accountability

All the faculty members are involved in inculcating the skills to the Post-graduate class members in matters of preparing interview schedules, collecting data from the villagers, preparation of coding manuals, entry of coded data, analysis of the data through SPSS and finally writing small reports.

Thrust Areas:

The main research thrusts of department are: Agrarian studies, Development studies, Social Exclusion and Subaltern studies, Sociology of Health and illness, Sociology of Science and Technology, Sociology of Sanitation and Social movements.

Programmes of Study:

S.No.	Programme of Study	Duration	No. of Seats	Specialization(s)
1.	Ph.D.	5 years (includes course work)	04	Social Exclusion, Development studies, Agrarian studies etc.
2.	M. A.	2 years	30	Rural Studies, Development studies, Social Exclusion, Sociology of Health etc.

Faculty members and their Area of Research:

S.No.	Name of Faculty	Designation	Area of Specialization
1.	Dr. Ashish Saxena	Professor & Head	Subaltern Studies; Agrarian Studies; Development Studies
2.	Dr. Muneer Illath	Assistant Professor	Sociology of Religion; Gender and Migration Studies; Sociology of Development; Sociology of Health
3.	Dr. Subhasis Sahoo	Assistant Professor	Sociology of Science and Technology; Social Movements; Sociology of Development

Support Staff:

S. No.	Name	Gender	Category	Designation	Work assigned
1.	Dr. Bandana Tripathi	Female	Gen	Office Assistant	Office Maintenance
2.	Ajay Kumar	Male	SC	Peon	Routine matters
3.	Lakhan Lal Shukla	Male	Gen	Peon	Routine matters

Details of Students, Year wise and Reservation wise (2018-2019):

Course	Gen			OBC			SC			ST			PwD			TOTAL		
	Male	Female	Total	Male	Female	Total	Male	Female	Total	Male	Female	Total	Male	Female	Total	Male	Female	Total
Ph.D.	01	05	06	02	07	09	01	02	03	00	00	00	00	01	01	04	15	19
MA I	08	03	11	06	04	10	05	01	06	01	00	01	01	00	01	21	08	29
MA II	05	07	12	09	02	11	05	01	06	00	01	01	01	00	01	20	11	31
Total	14	14	28	17	13	30	10	04	14	01	01	02	02	01	03	44	33	79

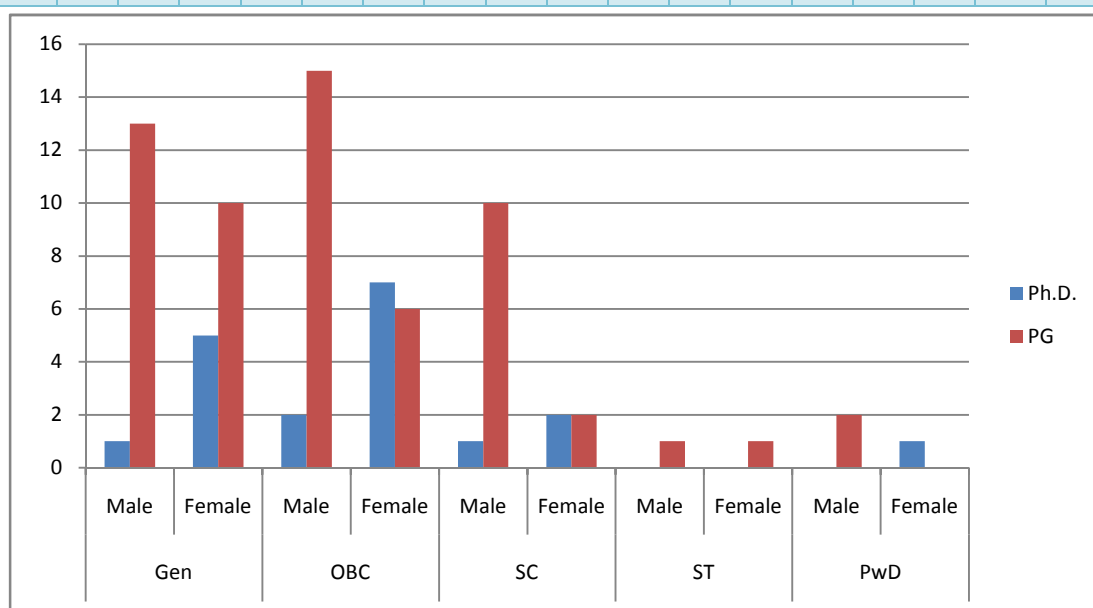

Student Enrollment for the Department

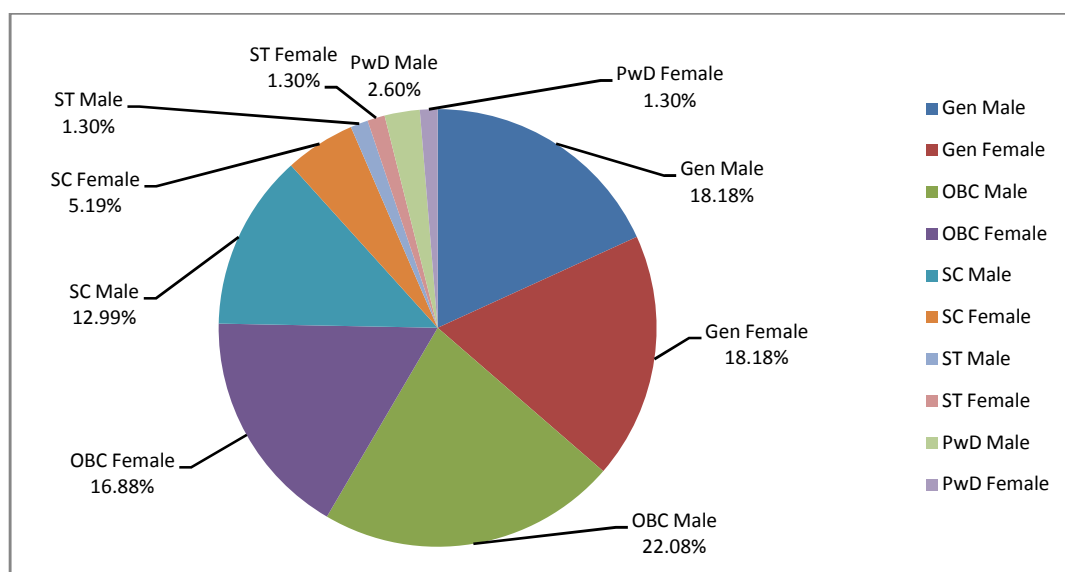

Gender wise distribution of Students

Seminars/Workshops/Conferences conducted by the Department/Centre:

S. No.	Name of the Seminar/workshop/conference	National / International	Duration and dates	Funding/sponsor Agenc(y/ies)	No. of Participants	No. of Papers presented
1.	Workshop on “Emerging Development Discourse, : A Critique”	National	26 th October, 2018	None (Faculty Contribution)	50	15

Training/orientation/refresher courses/special lectures conducted by the Department:

S.N.	Name of the course	Duration and dates	Funding/sponsor	Speakers
1.	Course work for Pre-Ph.D. programme	One semester	None (Faculty contribution)	Prof. Ashish Saxena, Dr. Muneer Illath, Dr. Subhasis Sahoo, Dr. Prashant Khattri, Dr. Sumit, Dr. Raju Parghi, Dr. Pundir and others
2.	Public Lecture	20 th April, 2018	None (Faculty Contribution)	Marriane Sarah Saulnier, Department of Anthropology, University of Montreal, Canada
3.	Workshop	13 th September 2018.	None	“Gandhi Fellowship” in collaboration with Piramal Foundation, New Delhi,
4.	Public Lecture	20 th September, 2018	None (Faculty Contribution)	Prof. Bibhuti B. Malik, Department of Sociology, BBAU, Lucknow
5.	Public Lecture	29 th September, 2018	None (Faculty Contribution)	Prof. Kirti Pandey, Department of Sociology, DDU Gorakhpur University
6.	Public Lecture	15 th November, 2018	None (Faculty Contribution)	Prof. R.L.Bhat, Department of Social Sector and development, , Central university of Jammu
7.	Public Lecture	25 th January, 2019	None (Faculty Contribution)	Prof. Chandrashekhar Bhat, Retd. Prof. of Sociology, University of Hyderabad, Hyderabad
8.	Workshop	1 st February, 2019	with MIDS, Chennai	“Regional Imagination in Social Science Discourse in India” ; Prof. Ananta K. Giri, MIDS, Chennai

Awards/Honours/Fellowship received:

S. No.	Name of Faculty Member/ Student who received award	Name of the award	Organization conferring award
1.	Dr. Subhasis Sahoo	Professor M.N. Srinivas Memorial prize	I.S.S, New Delhi

Outreach activities:

S. N.	Name of Faculty Member/Student/ Researcher	Title of the paper presented	Title of Conference/ Seminar etc	Duration of the conference/ assignment	Organized by
1.	Prof. Ashish Saxena	‘Towards Sociology of Sanitation in global era	‘Sociology of Sanitation’	25 th – 27 th June, 2018	Department of Sociology, Gujarat University, Ahmedabad
2.	Dr. Muneer Illath	Status of Women in Islam and Muslims societies in India	Gender concerns	29 th August 2018.	Centre for Women’s Studies, University of Allahabad
3.	Prof. Ashish Saxena	“Issues and Challenges for Youths in contemporary India	Youth in contemporary India: Issues, challenges and opportunities’	28-29 th October, 2018	Ishwar Saran P.G. College, Allahabad
4.	Dr. Muneer Illath	Education, Employment and Empowerment: Analyzing some development anomalies of Muslim women in Kerala	-	14-16 th November, 2018	Centre for Women’s Studies, Aligarh Muslim University
5.	Dr. Muneer Illath	Caste and Muslims in India: A Critique	-	29-30 th ovember, 2018	Department of Medieval and Modern History, UoA
6.	Prof. Ashish Saxena	<i>Issues and Concerns of Women empowerment in India: A Critical view’</i>	Women empowerment in present scenario’	22 nd – 23 rd December, 2018	M.L.K (P.G.) college, Balrampur
7.	Prof. Ashish Saxena	Issues and Concerns for Governance in India: A Sociological insight’	Socio-economic and administrative issues in 21 st century: Challenges and Solution	16 th – 17 th February 2019	M.G.K.V. P. University, Varanasi

S. N.	Name of Faculty Member/Student/ Researcher	Title of the paper presented	Title of Conference/ Seminar etc	Duration of the conference/ assignment	Organized by
8.	Prof. Ashish Saxena	Environment, Technology and Development in Rural India	Environment, Technology and Sustainable Development: Issues and Challenges	22 nd – 23 rd February 2019	DDU University, Gorakhpur
9.	Dr. Muneer Illath	Social Determinants of Health: Connecting Policies, Stakeholders and Field Realities	Environment, Technology and Sustainable Development: Issues and Challenges	22 nd – 23 rd February 2019	DDU University, Gorakhpur
10.	Prof. Ashish Saxena	Academic parameter and organizational performance in higher education	Faculty, Academic parameter and organizational Performance	10 th – 11 th March 2019	Ishwar Saran Degree College, Allahabad

Other information (about the department)

- (Ashish Saxena) Resource person for Special lecture on “Qualitative Research Methodology in Social Sciences’ organized by Department of Humanities & Social Sciences Motilal Nehru National Institute of Technology, Allahabad, 11th -17th June, 2018.
- (Ashish Saxena) Invited lecture at I.G.N.T. University, Amarkantak in 7th - 9th October, 2018 and delivered on ‘Contemptuous marginality: A case of Gujjar tribes of J&K.
- (Ashish Saxena) Resource person for Special lecture on “Research Methodology course in Social Sciences’ organized by Department of Education, M.G.K.V.P. University, Varanasi, 30th October, 2018.
- (Ashish Saxena) Resource person for INFLIBNET e-PG Pathshala, National Mission on Education through ICT for 4 module on Gender studies (An interdisciplinary look at feminist methodology; Mapping Women and Girl Child related initiatives across the Indian states; Indian Government initiatives for Women and Girls: A critical overview), June – October, 2018
- (Ashish Saxena) Resource person for Swayam Prabha, DTH Channel, MHRD, GoI for NPTEL online Certification course on ‘Development of Sociology in India organized by I.I.T Kanpur on August -September 2018’.
- (Ashish Saxena) Attended National workshop on Modules in Sociology and acted as Resource person for giving inputs for preparing modules as required by SWAYAM platform for Sociology at National Resource Centre, Karnatak University, Dharwad, 2nd – 3rd November, 2018.
- (Muneer Illath) Resource person and Chaired a session on ‘Political Sociology’ in Research Committee 07 of All India Sociological Conference organized by Indian Sociological Society at St. Philomena’s College, Mysore on 27-29th December 2018
- (Muneer Illath) Resource person and Chaired a session on Research Committee (RC) 24- Child and Childhood Studies of All India Sociological Conference organized by Indian Sociological Society at St. Philomena’s College, Mysore on 27-29th December 2018
- (Ashish Saxena) Resource person for Special lecture on “Research Methodology for Humanities & Social Sciences’ organized by Ishwar Saran Degree College, Allahabad, January, 2019.
- (Muneer Illath) Resource person for special lecture on “Qualitative Research Methods” on 5th April 2019 at Hamidia Girls’ Degree College, Allahabad.
- (Muneer Illath) Resource person for special lecture on “Introduction to Quantitative Research Methods in Social Sciences” on 8th April 2019 at Hamidia Girls’ Degree College, Allahabad
- (Ashish Saxena) Acted as Resource person in Sociology discipline for National Testing Agency, MHRD, Department of Higher Education, GoI, Noida, 14-18th January 2019.
- (Ashish Saxena, Coordinator; Muneer Illath, Co-Cordinator) Consultancy for Baseline survey of knowledge, attitude, practices (KAP) of citizens regarding Lok sabha general election 2019, SVEEP plan: With special reference to district Prayagraj, A Survey directed by District election office, prayagraj on behalf of CEO, U.P. & Election Commission of India, New Delhi. 2019 .



Public Lecture on on the theme “Theoretical Aspects of Social Exclusion and Inclusive Policies: A Critical Analysis” and “The Cobra-Women of North India: A metamorphosis of gender roles”. The lecture was delivered by Prof. Bibhuti B. Malik, BBAU, Lucknow and by Marriane Sarah Saulnier, Department of Anthropology, University of Montreal, Canada



National Workshop on 26th October, 2018 on the theme “Emerging Development Discourse: A Critique”



Public Lecture on and “Understanding Indian Diaspora: An overview”. The lectures were delivered by Prof. R.L.Bhatt, Central University of Jammu & Prof. Chandrashekhar Bhat, Retd. Prof., HCU, Hyderabad.



National Workshop with Madras Institute of Development Studies, Chennai on the theme “Regional Imagination in Social Science Discourse in India:

DEPARTMENT OF URDU

Introduction:

Department of Urdu, University of Allahabad is the oldest Department of Urdu, languages and literature in India which was establishment in the year 1924. Prof. Jamin Ali was the first Head of this department. Some of the notable figures belonging to this department include Prof. Ejaz Husain Prof. Ehtesham Husain Prof. Gyan Chand Jian and Prof. S.M Aquil Rizvi .Balwant Singh. Razia Sajjad Zaheer, shamim Hanfi. Tuzail Jafari are some of our alumni who were prominent writers of their time, department has a long cultural and Academics history .present head of Department Prof. Shabnam Hameed is considered to be one of the eminent scholars of Urdu throughout the world and she is leading progressive writer of our time.

Thrust Areas:

- Cultural Poetry.
- Urdu Fiction.
- Urdu Drama
- Tahjeeb –o- Tanqeed

Programmes of Study:

S.No.	Programme of Study	Duration	Specialization(s)
1.	Ph.D.	5 years(includes course work)	Above said thrust areas
2.	M. A./M. Sc.	2 years (Four Semester)	
3.	B. A./B. Sc.	3 years	Not Required
4.	Diploma Courses	2 years	

Faculty members and their Area of Research:

S.N.	Name of Faculty	Designation	Area of Specialization
1.	Dr. Ali Ahmad Fatmi	Professor	Urdu Fiction
2.	Dr. Mohd Kashif	Assistant Professor	Urdu Drama
3.	Dr. Naushaba Sardar	Professor	Criticism and Qaseeda
4.	Dr. Rizwana Shamsi	Assistant Professor	Urdu Fiction
5.	Dr. Sanjay Kumar	Assistant Professor	Urdu Poetry and Nazm
6.	Dr. Shabnam Hameed	Head and Professor	Urdu Drama and Poetry
7.	Dr. Zafarullah Ansari	Assistant Professor	Urdu Masnavi

Support Staff:

S.N.	Name	Gender	Category	Designation	Work assigned
1.	Haseena Begum	Female	Gen	M.T.S	Office work and Computer Work
2.	Raushan Ara	Female	OBC	Peon	Office Attendant

Details of Students, Programme wise and Reservation wise (2017-2018):

Course	Gen			OBC			SC			ST			PwD			TOTAL		
	Male	Female	Total	Male	Female	Total	Male	Female	Total	Male	Female	Total	Male	Female	Total	Male	Female	Total
Ph.D.	3	2	5	17	10	26	2	0	2	0	0	0	0	0	0	22	12	34
PG	29	20	49	132	232	364	3	0	3	0	0	0	0	1	1	164	253	417
UG	20	55	75	29	79	108	3	2	5	0	0	0	0	0	0	52	136	188
Diploma	3	1	4	5	2	7	7	0	7	0	0	0	0	0	0	15	3	18
Total	55	78	133	183	322	505	15	2	17	0	0	0	0	1	1	243	404	657

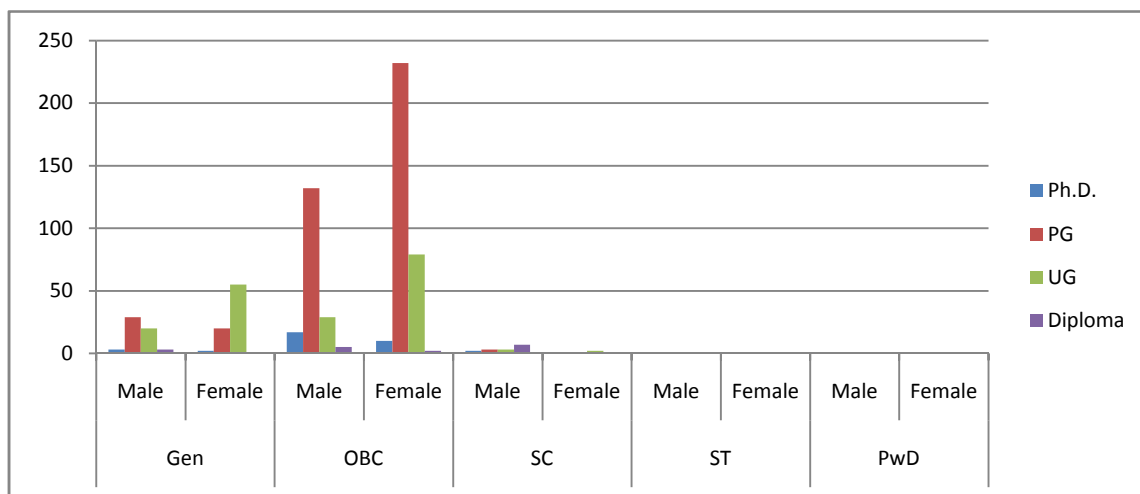

Student Enrollment for the Department

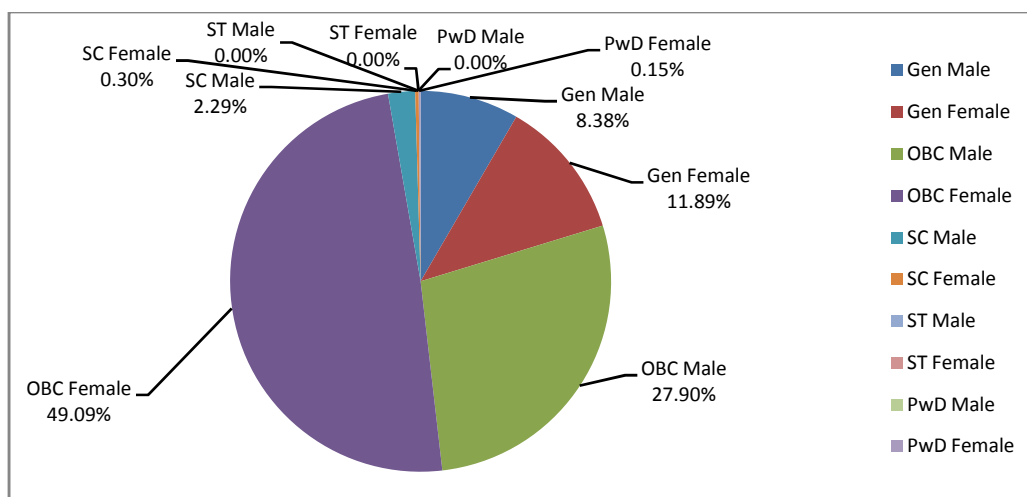

Gender wise distribution of Students

Seminars/Workshops/Conferences conducted by the Department/Centre:

S.N.	Name of the Seminar/ workshop/conference	National / International	Duration and dates
1.	Sir Syed Ahmad fikr-o- Nazar	National Seminar	27 February 2018

Training/orientation/refresher courses/special lectures conducted by the Department/Centre:

S.N.	Name of the course	Duration and dates	Funding/sponsor	Speakers
1.	Prof. Tara Chand Memorial lecture	National	31 October 2017	Prof. Mujavir Husain Rizvi
2.	Prof. Tara Chand Memorial lecture	National	20 February 2018	Prof. Shamsur Rahman Farooqi

Outreach activities:

S.N.	Name of Faculty Member/Student/ Researcher	Title of the paper presented	Title of Conference/ Seminar etc	Duration of the conference/ assignment	Organized by
1.	Dr. Sanjay Kumar	“Pandit Brij Narayan Chakbast Art and Artist”	International Seminar	4 th & 5 th October 2017.	University of Allahabad

DEPARTMENT OF VISUAL ARTS

Introduction :

The Department of Visual Arts was established in the year 1942 for the study of Painting. Kala Guru K. N. Majumdar, who had enriched the study of Bengal School of Painting, was founder of the Department. Besides Kala Guru K. N. Majumdar, Mr. D. P. Dulia, Mr. S. N. Mishra & Mrs. Bimla Niogi were the teachers of Painting, Applied Arts and Craft. The Department of Visual Arts is an important department in the University; It's board spectrum of ideas and practice is formed by many and varied approaches of the Arts. Each faculty member contributes to the variety of ideas and expertise in the subject.

Painting courses introduce the concepts and material of Art, Art history and further students understanding of space, image and colour etc. Visual Arts courses develop awareness of Applied Art, Sculpture, and Painting as the basic organizer of thought, feelings and image making. A range of materials, forms and traditions – both representational and non-representational – are explored. The courses investigate the relationship between painting and other form of Art. A variety of specific courses are taught by our department which consists experts in colour, space, anatomy, landscape, composition, still life, water colour, sculpture, photography etc. BFA course in painting and Techniques investigate the properties and possibilities of traditional and modern media.

Thrust Areas:

- Philosophical aspect of Art.
- Aesthetical concept of Art.
- Explore contemporary Arts and Artist
- Current scenario of Art etc

Programmes of Study:

S.N.	Programme of Study	Duration	No. of Seats	Specialization(s)
1.	Ph. D.	5 years(includes course work)	04	--
2.	M. A./M. Sc.	4 Semester(CBCS) in two year 4 Semester(CBCS) in two year	31 06	PAINTING
3.	B. A./B. Sc.	Three years in Graduation academic stream in Painting - 8 Semester (CBCS) in four year	31 61	--

Faculty members and their Area of Research:

S.N.	Name of Faculty	Gender	Designation	Area of Specialization
1.	Dr. A. K. Jaitly	MALE	Head & Professor	Painting
2.	Dr. Abhinav Gupta	MALE	Assistant professor	Painting

Support Staff:

S.N.	Name	Gender	Category	Designation	Work assigned
1.	Roshan Lal	Male	OBC	Clark	Official
2.	Kailash	Male	OBC	Peon	Official
3.	Badama	Female	OBC	Peon	Official

Details of Students, Year wise and Reservation wise (2018-2019):

Course	Gen			OBC			SC			ST			PwD			TOTAL		
	Male	Female	Total	Male	Female	Total	Male	Female	Total	Male	Female	Total	Male	Female	Total	Male	Female	Total
Ph.D.	-	-	-	2	2	4	-	-	-	-	-	-	-	-	-	2	2	4
PG	4	10	14	9	15	24	7	6	13	-	-	-	-	-	-	20	31	51
UG	17	26	43	47	47	121	37	18	55	1	2	3	-	-	-	102	120	222
Total	21	36	57	58	64	149	44	24	68	1	2	3	-	-	-	124	153	277

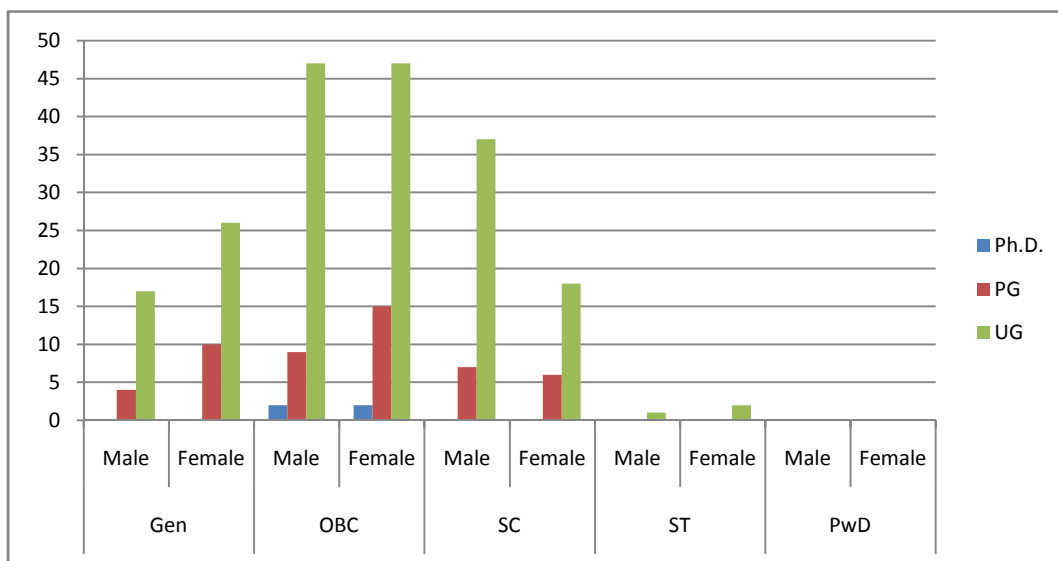

Student Enrollment for the Department

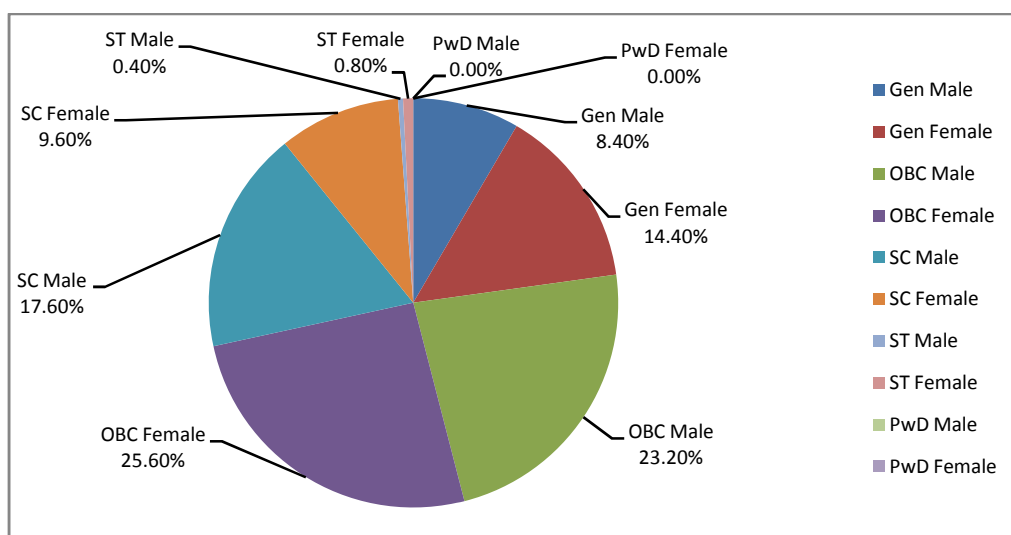

Gender wise distribution of Students

Seminars/Workshops/Conferences Conducted by the Department:

S.N.	Name of the Seminar/ Workshop/ Conference	National / International	Duration And Dates	Funding/Sponsor Agenc(Y/Ies)	No. of Participants
1.	Summer Workshop	National	9 - 18 June 2018	Rajya Lalit Kala Academy, Uttar Pradesh And Visual Art Department, UoA	60
2.	Kala Acharya Chitra Exhibition	National	20-21 Sept 2018	Rajya Lalit Kala Academy, Uttar Pradesh	60
3.	56th Foundation Day, Kala Parva, - 2018	National	2018	Rajya Lalit Kala Academy, Uttar Pradesh	60
4.	Ganga Manuhar, Rangoli Karyakram, Kumbh Mela		28 -1-2019	Sanskarbharti, Rajya Lalit Kala Academy, Uttar Pradesh & Department of Visual Arts, UoA	13

UNIVERSITY OF ALLAHABAD

S.N.	Name of the Seminar/ Workshop/ Conference	National / International	Duration And Dates	Funding/Sponsor Agenc(Y/ies)	No. of Participants
5.	Poster Comptition Systematic Voter's Education And Electoral Participation (Sweep)	National	10 -1-2019	Department of Visual Arts, University of Allahabad & Election Commition of India ,	70
6.	Painting Comptition 'Kala Ke Rang Kumbh Ke Sangh'	National	18/11/2018	Jointly Organized By Lait Kala Academy, Lucknow And Visual Arts, UoA at Allahabad Museum	60
7.	Chitrakala Pratiyogita, Kumbh Mela, Prayagraj,	State Level	17 Feb 2019	Jointly Organized By Lait Kala Academy, Lucknow and Visual Arts ,University of Allahabad (Prayagraj).	200
8.	Sand Art For Voter Awareness on Sangam Kumbh Mela, Prayagraj	National	10 March 2019	Jointly Organized By Sveep and University of Allahabad	80

Training/orientation/refresher courses/special lectures conducted by the Department/Centre:

S. No.	Name of the course	Duration and dates	Funding/sponsor	Speakers
1.	Refresher Course	24 Aug -13 Sept 2018	UGC HRD	Various eminent teachers from different University

Awards/Honours/Fellowship received:

S.No.	Name of Faculty Member/Student who received award	Name of the award	Organization conferring award
1.	Hina Yadav	JRF	UGC
2.	Dharmendra Kumar	15,000/- cash	Jointly Organized by Lait Kala Academy, Lucknow and University of Allahabad (Prayagraj).
3.	Manju Yadav	8,000/- cash	Jointly Organized by Lait Kala Academy, Lucknow and University of Allahabad (Prayagraj).

Outreach activities:

S.N.	Name of Faculty Member/Student/ Researcher	Title of the paper presented	Title of Conference/ Seminar etc	Duration of the assignment	Organized by
1.	Dhermendra Kumar	Painting Comptition	<i>Kala Ke Rang Kumbh Ke Sang</i>	18/11/2018	State Lalit Kala Academy , Lucknow ,U.P. & Allahabad Museum (Ministry of Culture ,Govt. Of India) Prayagraj,U.P.
		Jabalpur Street Art Festival	Wall Paintings	17 th To 25 th Nov.2018	Jabalpur Municipal Corporation And Jabalpur Smart City Ltd.
		Kalagram, Sanskritik Kumbh Mela,	Artists Camp	13-17 feb 2019	Lalit Kala Academy, Uttar Pradesh -2019
2.	Saptami Pal	"Lok Avam Saundrya"	Payanp An International Multidisciplinary Refereed Research Journal	Oct-Dec 2018	Lok Manav Samaj Kalyan Santhan Anurangabad (Bihar)-824101 In Association With K.R.Publishers And Distributors Baba Shopping Complex,Lanka Varanshi 05 Vol.-6, UGC NO.- 49095, ISSN-2347-4491. Page No. 131-134
		Painting Comptition	<i>Kala Ke Rang Kumbh Ke Sang</i>	18/11/2018	State Lalit Kala Academy, Lucknow, U.P. & Allahabad Museum (Ministry of Culture ,Govt. of India) Prayagraj,U.P.
		Natraj : Saanskritik Paryalochan	Natraj : Saanskritik Sambodhh	4-5 JUNE 2018]	Panchhamritam Dhham Jyotivrid Pandit Tikaram Jyoshi Smarak Samiti Porkhha – Bhhavli Gav Nainital ,Utrakhhand, Pa.No:25
3	Manju Yadav	Painting Comptition	'Kala Ke Rang Kumbh Ke Sangh'	18/11/2018	State Lalit Kala Academy, Lucknow ,U.P. & Allahabad Museum (Ministry of Culture, Govt. of India) Prayagraj,U.P.
		An Art Exhibition	"Kala Acharya"	20-21 SEP	State Lalit Kala Akedemi U.P.

S.N.	Name of Faculty Member/Student/ Researcher	Title of the paper presented	Title of Conference/ Seminar etc	Duration of the assignment	Organized by
4	Priti Singh	Punlication	Bharthey Lok Kala Ka Kalatamak Avirbhav : Ek Adhyyan	SEP 2018	K.R.Publishers Distributors, Varanasi, ISSN: 2347-4491, Page No. 178-81.
		Painting Comptition	'Kala Ke Rang Kumbh Ke Sangh'	18/11/2018	State Lalit Kala Academy, Lucknow, U.P. & Allahabad Museum (Ministry of Culture, Govt. Of India) Prayagraj,U.P.
5	Hina Yadav	An Art Exhibition "Madhyakaleen Hindi Kavita Ka Anya Lalit Kalaa Se Antahsambandhh"	"Kalaon Mein Antersambandh Va Madhyakaleen Kavya Me Prasfutip Bakti Bhavna Ka Ujaash"	20-21 SEP 6-8 MARCH 2019	State Lalit Kala Akedemi U.P. Hindi Vibhag, Indira Kala Sangeet Vishwavidhyalaya, Khairagadh (Chhatisgadh) India.
		Painting Comptition	'Kala Ke Rang Kumbh Ke Sangh'	18/11/2018	Jointly Organized by Lait Kala Academy, Lucknow and UoA (Prayagraj).
		An Art Exhibition	"Kala Acharya"	20-21 september 2018	State lalit kala akedemi U.P. & A
6.	Rituraj Raman	Painting Comptition	'Kala Ke Rang Kumbh Ke Sangh'	18/11/2018	Jointly Organized by Lait Kala Academy, Lucknow and UoA (Prayagraj).
		An Art Exhibition	"Kala Acharya"	20-21 September	State Lalit Kala Akedemi U.P. & A
		Summer Workshop	Painting (Water Colour)	9 th - June - 9 July 2018	Lalit Kala Academy ,U.P. , Delegacy & Department Of Visual Arts, UoA



Participation by Visual Art Department, University of Allahabad in Lalit kala Artist Camp-2019



Sand Art organized by Visual Arts, AU And SVEEP on Sangam 10 March 2019



Solo Art Exhibition of BFA II & IV sem student organized by Nirala Arts gallery & Visual Arts, AU. on 3-4 May 2019



'KALA KE RANG KUMBH KE SANGH' art exhibition Jointly Organized by Lait Kala Academy, Lucknow and Visual Arts, University of Allahabad (Prayagraj) at Allahabad Museum on 18/11/2018



Kala Acharya Art Exhibition organised by Jointly Organized by Lait Kala Academy, Lucknow and Visual Arts, University of Allahabad (Prayagraj) at NCZCC on 20-21 Sept 2018



Summer workshop organised by Rajya Lalit Kala Academy, Uttar Pradesh and Visual Art Department, Allahabad University, Prayagraj from 9 July-18 June 2018



Paint my city, Sichai vibhag at sangam by student of Visual Arts, University of Allahabad (Prayagraj)

FACULTY OF COMMERCE

DEPARTMENT OF COMMERCE & BUSINESS ADMINISTRATION

Introduction:

The Department was set up in 1924 with the introduction of UG/PG teaching in Commerce. The Management wing was added in 1965 with the setting up of Motilal Nehru Institute of Research and Business Administration and the launching of PG programme leading to the award of Master's degree in Business Administration. In fact the Department was the first among the Indian University departments to take a lead in starting formal education in Management. During the year the academic calendar was strictly observed and the admissions, teaching, and examinations for various classes were held on time.

Thrust Areas:

- Finance & Accounting
- Marketing
- Human Resource Management
- Information Technology

Programmes of Study:

S.No.	Programme of Study	Duration	No. of Seats	Specialization(s)
1.	Ph.D.	5 years (includes course work)		All areas of Commerce and Management
2.	M. Com.	2 years	270	(a) International Finance; (b) Human Resource Policy & Practices; (c) Advertising & Media Planning
3.	M.B.A.	2 years	46	Marketing; Finance; Human Resource; Systems.
4.	B. Com.	3 years	578	--

Faculty members and their Area of Research:

S.No.	Name	Designation	Area of Specialization/Research
1.	Dr. A. K. Mukherjee	Professor & Head	Organisational Behaviour and Financial Accounting
2.	Dr. A.K. Malviya	Professor	Marketing Management and Tourism
3.	Dr. Ajai Kumar Singhal	Professor	Taxation and HRM
4.	Dr. Akhilesh Chandra Pandey	Assistant Professor	Marketing and Strategic Management
5.	Dr. Anvita Raghuvanshi	Assistant Professor	Accounting & Finance
6.	Dr. Archana Singh	Assistant Professor	Accounting & Finance
7.	Dr. Arun Kumar	Professor	Application of ICT in Business; Organizational and Personal Effectiveness; Quality Mgt. System
8.	Dr. Ekta Verma	Assistant Professor	Marketing Management; HRM & Business Communication; Entrepreneurship; Management of Services
9.	Dr. Hariom Gupta	Assistant Professor	Accounting & Finance
10.	Dr. Himanshu Srivastava	Assistant Professor	Financial Services and Law
11.	Dr. J. N. Bhargava	Professor	Marketing., MIS, Operations, Strategic Mgt.

S.No.	Name	Designation	Area of Specialization/Research
12.	Dr. Jitendra Kumar Singh	Assistant Professor	System Management
13.	Dr. M. Motihar	Professor	Insurance and Marketing Research
14.	Dr. Pradeep Jain	Professor	Legal Environment and Marketing Mgt.
15.	Dr. R. K. Singh	Associate Professor	Finance, Accounts and Business Ethics
16.	Dr. R. S. Singh	Professor	HRM
17.	Dr. S. A. Ansari	Professor	Accounting and Finance
18.	Dr. S. M. Z. Khurshid	Associate Professor	Marketing; HRM; Advertising & Media Planning
19.	Dr. Sarita Maxwell	Assistant Professor	Marketing Management & HRM
20.	Dr. Shefali Nandan	Assistant Professor	HRM, OB, Industrial Relations

Details of Other Academic Staff:

S. No.	Name	Designation	Area of Specialization
1.	Dr. Kamlesh Kumari	Research Investigator	Business Environment
2.	Dr. Keshav Shyam	Research Asstt.	Finance & Accounting
3.	Dr. Umesh Dwivedi	Research Asstt.	Business Economics
4.	Dr. Ajai Tiwari	Statistical Supervisor	Operations Research; Business Statistics

Support Staff:

S. No.	Name	Gender	Category	Designation/work	Work Assigned
1.	Dwarika Prasad	Male	GEN	Office Assistant	Departmental Accounts; official work and Computer Typing
2.	Neeraj Mishra	Male	GEN	Office Assistant	Commerce office work
3.	Vijay Kumar Singh	Male	OBC	Tech. Assistant	Photocopying; Class room technical maintenance
4.	Neeraj Kumar Verma	Male	GEN	Lab Assistant	Computer Work
5.	G. K. Rao	Male	GEN	Lib. Assistant	Library work
6.	Dharmidhar Upadhyaya	Male	GEN	Lab. Attendant/Peon	Office work assigned by the HOD
7.	Anand Nandan	Male	SC	Peon	Office work assigned by the HOD
8.	Sukumari Mandal	Male	SC	Peon	Office work assigned by the HOD
9.	Raju	Male	OBC	Peon	Office work assigned by the HOD
10.	Shahban Ali	Male	OBC	Peon	Office work assigned by the HOD
11.	Kailashpati Tripathi	Male	GEN	Book Attendant/Peon	Commerce Library work
12.	Sadashiv	Male	OBC	Gardner	Gardening
13.	Pratap Bahadur	Male	OBC	Gardner	Gardening
14.	Azad	Male	SC	Sweeper	Cleaning, dusting, mopping

Details of Students, Year wise and Reservation wise (2018-2019):

Course	Gen			OBC			SC			ST			PwD			TOTAL		
	Male	Female	Total	Male	Female	Total	Male	Female	Total	Male	Female	Total	Male	Female	Total	Male	Female	Total
Ph.D.	24	14	38	22	14	36	05	03	08	-	-	-	03	-	03	51	31	82
M.Com.	113	96	209	69	60	129	42	29	71	22	10	32	05	01	06	246	195	441
MBA	32	15	47	21	07	28	12	03	15	06	01	07	01	-	01	71	26	97
B.Com	378	293	671	246	197	443	139	88	227	62	27	89	15	02	17	825	605	1430
Total	547	418	965	358	275	633	198	123	321	90	38	128	24	03	27	1193	857	2050

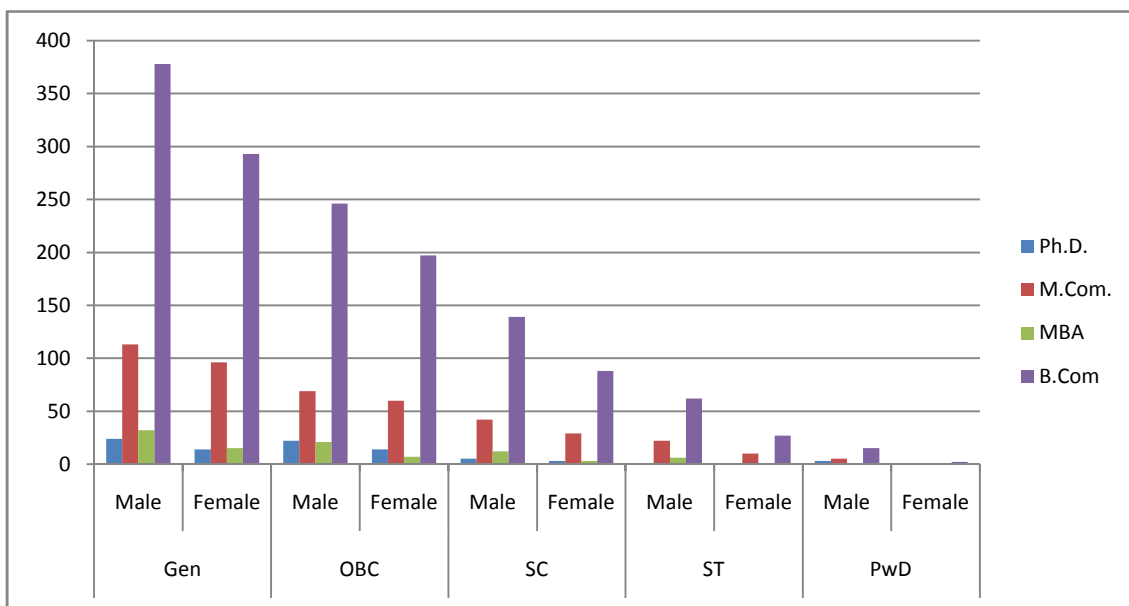

Student Enrollment for the Department

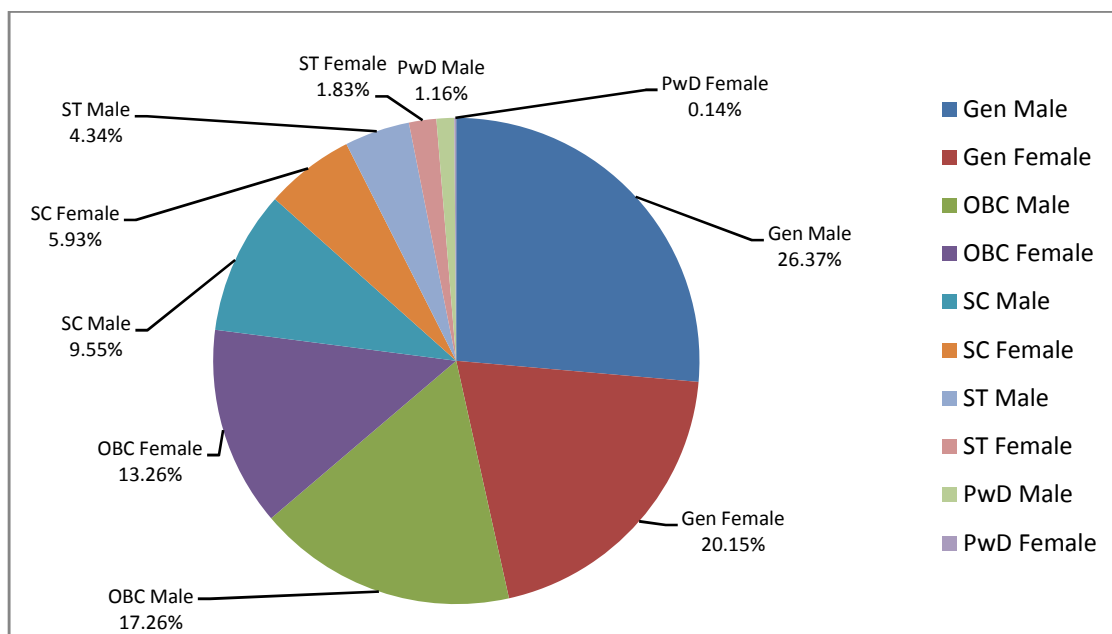

Gender wise distribution of Students

Training/orientation/refresher courses/special lectures conducted by the Department:

S. No.	Name of the course	Duration and dates	Funding/sponsor	Speakers
1.	Financial Awareness & Consumer Training (FACT)	27 February 2019	National Centre for Financial Education	Mr. Meraz Ahmad, Consultant

S. No.	Name of the course	Duration and dates	Funding/sponsor	Speakers
2.	Workshop on Business Analytics	23-24 February 2019	organized by Department of Commerce and Business Administration in collaboration with Makeintern.	

Awards/Honours/Fellowship received:

S.No.	Name of Faculty Member/Student who received award	Name of the award	Organization conferring award
1.	Prof. S A Ansari	Award of Excellence	University of Allahabad
2.	Prof. Arun Kumar	Award of Excellence	University of Allahabad

Academic Organizations (headquartered in the department/Centre):

S.No.	Name	Nature	Objectives
1.	Agro-Economic Research Centre Ministry of Agricultural, Govt. of India	National	To carry on research on fundamental problems relating to agricultural economy of India. To conduct ad-hoc studies in the problems in which Government of India is specially interested. To give technical advice to the Government of India and State Governments of Uttar Pradesh/ Bihar in the field of Agricultural Economics and Rural Sociology.

Journals published by the Department/Centre:

S. No.	Title	Nature	Established	Annual/bi-annual /quarterly	ISSN
1.	The Commerce Journal	National	1960	Annual	2230-7222

Proposed Courses

S.No.	Name of Programme	Nature	Duration	Proposed or In process	Intake of Students	Remarks
1.	Digital Marketing	Certificate Course	One Year	Proposed	30	Self-Finance
2.	Disaster Management	Certificate Course	One Year	Proposed	30	Self-Finance
3.	Accounting & Financial Management	Certificate Course	One Year	Proposed	30	Self-Finance
4.	Rural Marketing	Certificate Course	One Year	Proposed	30	Self-Finance

Outreach activities

S. N.	Name of the Faculty	Title of the paper presented	Title of Conference / Seminar etc	Duration of the conference / assignment	Organised by
1.	Prof Arun Kumar	Invited lecture on: Religious Tourism and Entrepreneurial Development of Indigenous Population	International Conference on Indigenous and Religious Tourism in South and East Asia: Opportunities and Challenges	January, 11-13, 2019	Indira Gandhi National Tribal University at Amarkantak, Madhya Pradesh- India
2.	Dr. Shefali Nandan	Psychological Determinants of Entrepreneurship Behaviour: A Review of Literature (Second best paper award)	Idea Conclave on Collaging Futuristic Skills Landscape for New India- A Development Professionals Meet	7-8 March 2019	GB Pant Institute of Social Sciences, Prayagraj
	Dr. Shefali Nandan	Organisational Culture Dimensions as Drivers of Employee Engagement for Business Sustainability: Towards a Conceptual Framework	International Conference on Sustainable Human Resource Management: Practices, Policies and Perspectives in South Asia	01-02 Nov 2018,	Hyderabad University
	Dr. Shefali Nandan	Change Management as An Organisational Sustainability Strategy: Exploring the Literature	International Conference on Sustainable Human Resource Management: Practices, Policies and Perspectives in South Asia	01-02 Nov 2018,	Hyderabad University

S. N.	Name of the Faculty	Title of the paper presented	Title of Conference / Seminar etc	Duration of the conference / assignment	Organised by
	Dr. Shefali Nandan	Invited lecture on: Futuristic Skills Landscape	Idea Conclave on Collaging Futuristic Skills Landscape for New India- A Development Professionals Meet	7-8 March 2019	GB Pant Institute of Social Sciences, Prayagraj
	Dr. Shefali Nandan	Invited lecture on: Soft Skills Development for Entrepreneurship	Entrepreneurship Awareness Camp	11-13 March 2019	Women's Polytechnic, Prayagraj , organised by UP Industrial Consultants Entrepreneurship Development Institute of India under DST-NIMAT Project
	Dr. Shefali Nandan	Invited lecture on: Developing Entrepreneurial Competencies-Communication Skills', on 23 February 2019	Entrepreneurship Awareness Camp	21-23 Feb 2019	Regional Vocational Training Institute (RVTI) for Women , organised by UP Industrial Consultants Entrepreneurship Development Institute of India under DST-NIMAT Project, at Women's Polytechnic, Prayagraj
	Dr. Shefali Nandan	Invited lecture on: 'Awareness and Prevention of Sexual Harassment', Organised by, 18 February 2019	7 days NSS camp of Unit II	12-18 February 2019	NSS camp of Unit II, University of Allahabad
	Dr. Shefali Nandan	Invited lecture on: Data Collection for Case Study 'Case development: Practical Applications'	FDP on Case Study Methods: Learning, Teaching and Writing	17-21 December 2018	School of Management Studies, Motilal Nehru National Institute of Technology Allahabad
	Dr. Shefali Nandan	Invited lecture on: 'Case study method: Practical Examples'	FDP on Case Study Methods: Learning, Teaching and Writing	17-21 December 2018	School of Management Studies, Motilal Nehru National Institute of Technology Allahabad
	Dr. Shefali Nandan	Invited lecture on: Lecture on Listening Skills in the, organized by	Workshop on 'The Art of Communication',	13-15 December 2018	Ishwar Saran Degree College, Allahabad
WORKSHOP					
	Dr. Shefali Nandan	N.A	Management Research in the Indian Context: Opportunities and challenges	4-6 Jan 2019	IIM Ahmedabad and Indian Academy of Management

Other information (about the department/Center)

- Dr. Shefali Nandan Coordinated the two-day Workshop on Business Analytics 23-24 February 2019, organized by Department of Commerce and Business Administration in collaboration with Makeintern.
- Dr. Akhilesh Chandra Pandey Coordinated the Regional Workshop on 'Financial Awareness and Consumer Training', 27 Feb 2019, organized by Department of Commerce and Business Administration in collaboration with National Centre for Financial Education
- Dr. Shefali Nandan Coordinated the Regional Workshop on 'Financial Awareness and Consumer Training', 27 Feb 2019, organized by Department of Commerce and Business Administration in collaboration with National Centre for Financial Education

DEPARTMENT OF ECONOMICS

Introduction:

The Department of Economics became a truly full-fledged department in 1914, with the appointment of Herbert Stanley Jevons (son of the marginalist, W.S. Jevons) as the first Professor of Economics and Head. A post-graduate course was also introduced the same year, so that the full fledgling department offered both, under-graduate and post-graduate courses. Origins are like riddles which may never be completely solved, and the Department of Economics is no exception. However, some sources also point to the year 1908, when the teaching of Economics as a subject commenced at the under-graduate level, though it remained under the Head of the then History Department. In view of the above, 2014 is taken to be its Centenary Year of the Department. Prof. Jevons also founded the Indian Journal of Economics, in the year 1916, the first economics journal ever to be published in India. This is the oldest existing journal of Economics and is regularly published, even today. In an article, published in its first volume in 1916 and available even today in the Department, Prof. Jevons wrote that his academic purpose was “*teaching to think and to do, rather than of teaching only to know*”.

This legacy of his was faithfully adhered to by stalwarts like Professors C.D.Thompson, A.R.Burnett-Hurst and S.K.Rudra, Mr. B.P.Adarkar, and later by Professors J.K.Mehta, P.C.Jain, S.L.Parmar, Mahesh Chand and many others. Faculty members such as Prof. H.S. Jevons, Prof. C.D. Thompson, Prof. S.K. Rudra and Prof. J.K.Mehta became Presidents of the Indian Economic Association Conferences of 1922, 1934, 1946, and 1968 respectively. Former faculty of the Department who became Presidents were Dr. M.V. Mathur (1967), Prof. Gautam Mathur (1978) and Prof. P.D. Hajela (1980). Allahabad had the proud privilege of hosting I.E.A. conferences in the years 1920, 1929 and 1940.

The Department recently formed an Alumni Association and the first Alumni meet was organized on Feb.14, 2014, the meet was a grand success and it was attended by more than two hundred alumni. The Department is holding meetings of the Association every year since then. The Department has celebrated its Centenary Year and many academic/cultural programmes were held during this 2014-2016.

Programmes of Study

S.N.	Programme of Study	Duration	No. of Seats
1.	Ph.D.	5 years(includes course work)	10
2.	M. A./M. Sc.	02 years	215
3.	B. A.	03 years	1824

Faculty members and their Area of Research:

S. No.	Name of Faculty	Gender	Designation	Area of Specialization
1.	Dr. Anup Kumar	Male	Assistant Professor	International Economics, Micro Economics, Globalization Studies
2.	Dr. Deepshikha Sonker	Female	Assistant Professor	Agricultural Economics, Economics of Industry
3.	Dr. Dhramnath Uraon	Male	Assistant Professor	Econometrics, Mathematical Statistics, Public Finance
4.	Dr. G.C. Tripathi	Male	Professor	Economics of Industry, Monetary Economics
5.	Dr. Javed Akhtar	Male	Associate Professor	Mathematical Economics, Econometrics
6.	Dr. Karim Ullah	Male	Assistant Professor	Rural Development, Agricultural Economics
7.	Dr. Kiran Singh	Female	Professor	Econometrics, Monetary Economics
8.	Dr. Man Mohan Krishna	Male	Professor	Agricultural Economics
9.	Dr. Nisha Srivastava	Male	Professor	International Economics, Indian Economic Policy
10.	Dr. Pradeep Kumar Singh	Male	Assistant Professor	Economic Theory, Gender Studies, Development Economics
11.	Dr. Prahlad Kumar	Male	Professor	International Economics, India's Foreign Trade & Policy & Globalization Studies
12.	Dr. Prashant Kumar Ghosh	Male	Professor	Economics of Human Resources, Publics Finance ,Social Sector
13.	Dr. Rekha Gupta	Female	Assistant Professor	Economics of Human Resource, Planning &

S. No.	Name of Faculty	Gender	Designation	Area of Specialization
				Development, Women's Studies
14.	Dr. Suneel Kumar Chaturvedi	Male	Professor	Development & Planning, Macro Economics
15.	Dr. Swati Jain	Female	Assistant Professor	Mathematical Economics, Mathematical Statistics

Support Staff:

S.N.	Name	Gender	Category	Designation
1.	Jay Prakash Yadav	Male	OBC	Lab Assistant
2.	Kamlesh Singh	Male	OBC	Junior Office Assistant
3.	Siddh Nath Padey	Male	GEN	Junior Office Assistant
4.	Radhey Shayam Yadav	Male	OBC	Peon
5.	Akhilesh Kumar	Male	OBC	Peon
6.	Hari Prakash Verma	Male	OBC	Peon
7.	Munni Devi	Female	SC	Peon
8.	Ramesh Kumar	Male	OBC	Peon
9.	Manish Kumar	Male	OBC	Computer Operator Lab

Details of Students, Year wise and Reservation wise (2018-2019):

Course	Gen			OBC			SC			ST			PwD			TOTAL		
	Male	Female	Total	Male	Female	Total	Male	Female	Total	Male	Female	Total	Male	Female	Total	Male	Female	Total
Ph.D.	5	1	6	1	1	2	1		1	1	-	1	-	-	-	6	4	10
PG	50	8	62	84	20	109	39	9	48	1	3	4			1	180	35	215
UG	431	121	552	723	143	857	313	62	375	35	05	40				1493	331	1824
Total	486	130	620	808	164	968	353	71	424	37	8	45	0	0	1	1679	370	2049

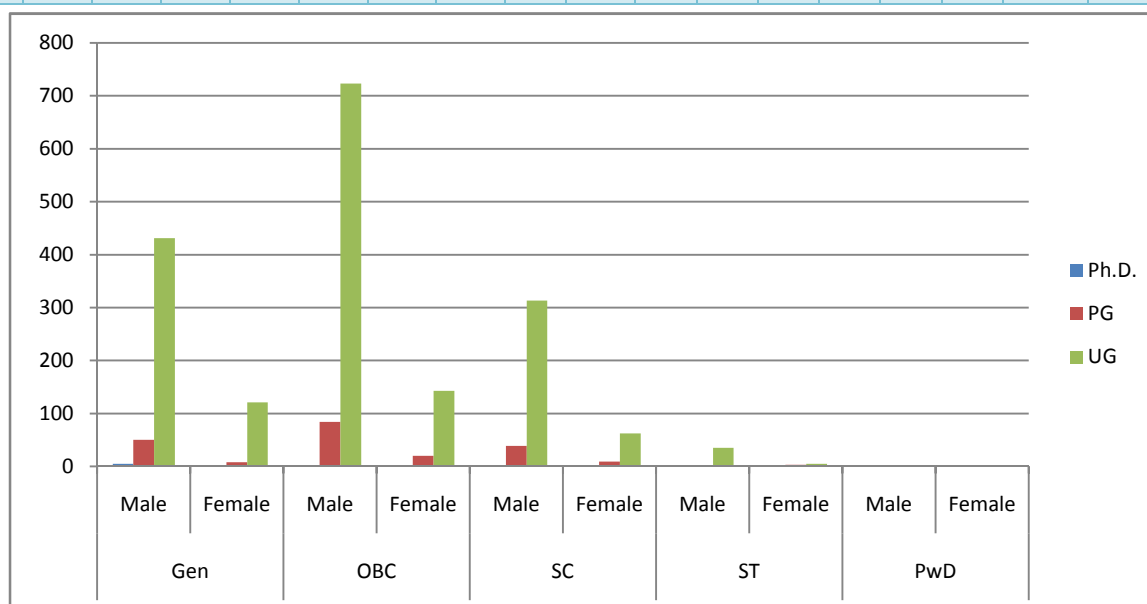

Student Enrollment for the Department

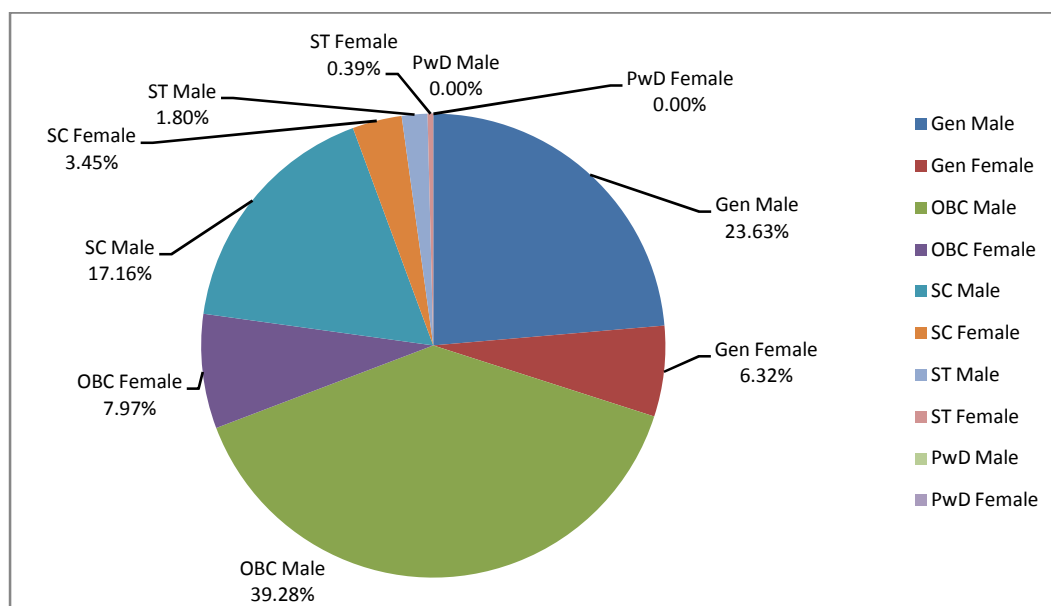

Gender wise distribution of Students

Seminars/Workshops/Conferences conducted by the Department/Centre:

S. No.	Name of the Seminar/workshop/conference	National / International	Duration and dates	Funding/sponsor Agency(y/ies)	No. of Participants	No. of Papers presented
1.	Cashless Economy and Financial Inclusion in India: Issues and Challenges	National	Two Day March 23-24, 2018	NADARD, ICSSR Planning & Development Unit	250	135
2.	Monetary Policy and Macroeconomic Issues & Challenges	Regional	Two Day February 15-16, 2019	Department of Economics, AU	120	Deliberations by speakers from RBI, Allahabad Bank, PNB, etc.

Awards/Honours/Fellowship received:

S.N.	Name of Faculty Member/ Student who received award	Name of the award	Organization conferring award
1.	Prof. D.K.Srivastava	Prof. J.K. Mehta Award	Alumni Association, Department of Economics University of Allahabad
2.	Dr. Pradeep Kumar Singh	Award of Excellence	University of Allahabad

Funding received during the period:

S.No.	Agency	Purpose	Amount
1.	U.G.C. Sap III DRS III	Seminar	1.5 Lakhs
2.	Planning & Development Unit	Seminar	1.5 Lakhs

Journals published by the Department/Centre:

S.No.	Title	Nature	Established	Frequency	ISSN
1.	Indian Journal of Economics, UoA	International	1916	Quarterly	0019-5170
2.	VARTA	International	1980	Bi-Annual	0970

Other publications by the Department/Centre

S.No.	Title	Type	Author(s)	Publication	ISBN
1.	Role of Dairy Sector in Increasing Farmers' Income in Uttar Pradesh	Biannual-Bilingual Refereed Journal of Economics	Neelu Mishra & P. K. Ghosh	U.P. & Uttrakhand Economics Association	ISSN – 0975-2382
2.	Book	Food Security in India (Dimensions and Challenges) Article titled, "Sustainable Agriculture for Food Security in Indian context."	Shri Javed Akhtar	Book. Anubhav Publishing House, Allahabad	
3.	Edited Book	Recent Trends in Economics and Management	Dr. Pavnesh Kumar & Dr. Pradeep Kumar Singh	Research India Publications, New Delhi, India	978-93-87374-55-3
4.	Social Welfare Schemes and their implementation : Status of Industrial workers in Kanpur District Uttar Pradesh		Dr. Deepshikha Sonker	UPUEA Economics Journal 14 th Annual Conference Vol-14 Conference No-14 Oct-2018	097523
5.	Global Economic Crisis and Indian Economy: An Empirical Analysis of Role of FIIs Investment Behaviour	Vol. 9, No. 1, pp. 47-57	Dr. Karimullah & Dr. Pradeep Kumar Singh	<i>Al-Barkaat Journal of Finance & Management</i>	

Proposed Projects/SAP Grants etc.

S.N.	Type of Project/grant	Title/Name	Duration	Proposed amount	Proposed or In process
1.	SAP-III DRS-III	Social Sector	5 Years	97 Lakhs	2015-2020

Outreach activities:

S.N.	Name of Faculty Member/Student/ Researcher	Title of the paper presented	Title of Conference/ Seminar etc	Duration of the assignment	Organized by
1.	Dr. Pradeep Kumar Singh	<i>Chaired the Technical Session</i>	<i>Indian Economy: Challenges and Prospects</i>	March 3-4, 2018	Centre for Study and Research (CSR), Hyderabad and Council on Economic Research, New Delhi
2.	Dr. Pradeep Kumar Singh	<i>Chaired the Technical Session</i>	<i>Digital India Programme- An Initiative to Transform Nation: Emerging Issues and Challenges</i>	October 5-6, 2018	Department of Political Science, Government Girls' P. G. College, Bindki, Fatehpur
3.	Dr. Pradeep Kumar Singh	Recent Development Experience and Challenges of Low Income States in India: with special reference to UP and Uttarakhand	<i>UPUEA 14th annual Conference</i>	29th and 30th October 2018	Giri Institute of Development Studies, Aliganj, Lucknow Supported by NABARD
4	Prof. P. K. Ghosh	<i>The Role of NGOs in Social Transformation</i>	<i>National Seminar</i>	November 13, 2018	Devi Ahilyabai University, Indore
5	Dr. Karimullah	<i>Chaired the Technical Session</i>	Digital India Programme- an Initiative to Transform Nation: Emerging Issues and Challenges	October 5-6, 2018	Department of Political Science, Government Girls' P. G. College, Bindki, Fatehpur
6	Dr. Karimullah	<i>Chaired the Technical Session</i>	<i>Indian Economy: Challenges and Prospects</i>	March 3-4, 2018	Centre for Study and Research (CSR), Hyderabad and Council on Economic Research, New Delhi

FACULTY OF LAW

DEPARTMENT OF LAW

Introduction

Law as a subject was introduced in the year 1872 in affiliation with the Calcutta University. In 1887 the Department of Law was established and in the year 1890, the Department became a separate single Department /Faculty of the University along with the faculties of Arts, Science and Commerce. Hon'ble Justice D. Straight was appointed as the first president of the Department. The Law Department functioned in Muir College from 1872 onwards till the new building was constructed for the Law Faculty around 1910, adjacent to Senate House. By an Act of the United Province of British India Prof. Weir, a distinguished jurist became the first Head of the Law Department. The Department was sifted to the new building which was constructed by UGC grant in the Chatham Lines Campus of which Hon'ble Mr. A.K. Sen the then Law Minister of India, had laid the foundation stone in 1965

The endeavour at Faculty of Law, University of Allahabad is to provide excellence in legal education. We aim at expanding the horizons of legal knowledge for full growth of human personality and well being of man kind. We also aim at devising, developing and applying new teaching techniques, research methods and also arrange for extension programmes in legal education. We strive to develop better human resources for trade, industry, public administration, departments of law and justice. Our continuous endeavour is to promote studies in law, legal institutions and processes of justice in close context of the knowledge of other disciplines having vital bearing on human behaviour and society in all aspects.

In keeping with its best tradition of reform and excellence in legal education, the University launched a Five Year Integrated Course of Law w.e.f. the academic session 2005-16. Its prime purpose and avowed aim is to fashion new technique of teaching and design courses to cope with the challenges and issues in contemporary society. A separate building for Law Five Year Integrated course has been build in the same premises.

Thrust Areas:

The department is engaged in various research areas including Law Relating to:

- Human Rights
- Intellectual Property Rights
- Environmental Law
- Cyber Law
- International Law
- Gender Studies in addition to the traditional fields of Constitutional Law, Personal Law and Administrative Law etc.

Programmes of Study: (Courses Run by the Department/Centre)

S.N.	Programme of Study	Duration	No. of seats
1	Ph.D.	5 years (includes course work)	As per vacancy
2	LL.M.	2 years	63
3	LL.B. (Hons): 3 year Course	3 years	300
4	B.A.LL.B. (Hons): 5 year Integrated Course	5 years	120

Faculty members and their Area of Research / Specialization:

S.No.	Name of Faculty	Gender	Designation	Area of Specialization
1.	Dr. Abhishek Kumar	M	Assistant Professor	Human Rights, International Law, Right to information Law
2.	Dr. Ajai Singh	M	Assistant Professor	Constitutional Law, Business Law, Family Law

S.No.	Name of Faculty	Gender	Designation	Area of Specialization
3.	Dr. Anshuman Mishra	M	Assistant Professor	Constitutional Law, Administrative Law, Information Technology Law, Jurisprudence-II, Law of evidence
4.	Dr. D.N. Pandey	M	Professor	Muslim Law, Property Laws
5.	Dr. Haribansh Singh	M	Assistant Professor	Environmental Law, Constitutional Law, Taxation
6.	Dr. J. P. Mishra	M	Professor	Jurisprudence, Constitutional Law, Intellectual Property Rights Law
7.	Dr. Jai Shankar Singh	M	Professor	Professional Ethics, Public International Law, Private International Law, Comparative Constitutional Law (UK & USA)
8.	Dr. L.M. Singh	M	Professor	Criminal Law, Administrative Law
9.	Dr. Mukta Verma	F	Assistant Professor	Constitutional Law, Patent Law
10.	Dr. N. P. Verma	M	Assistant Professor	Equity, Trust and Easement Environmental Law, International Organization, Hindu Law
11.	Dr. R. K. Chaubey	M	Professor	Constitutional Law, Taxation, Administrative Law, Law of Evidence, Cyber Law
12.	Dr. Rakesh Khanna	M	Professor	Criminal Law, Constitutional Law
13.	Dr. Rashmi Thakur	F	Assistant Professor	Human Right, Criminal Law, Right to Information Law
14.	Dr. Roshan Lal	M	Assistant Professor	Professional Ethics, ADR, Women And Criminal Law
15.	Dr. Siddh Nath	M	Professor	Law of Contract, Company Law
16.	Dr. Sonal Shankar	F	Assistant Professor	Law of Contract, Administrative Law, Feminist Jurisprudence

Support Staff: (Regular Employees) LL.B. (Hons) : Three Year Degree Course)

Non-teaching Group B employees:

S.No.	Name	Gender	Category	Designation	Work assigned
1	Sri N.K. Mishra	Male	Gen	Job Receptionist	Receptionist
2	Sri Deepak Bharati	Male	SC	Personal Assistant	Steno cum computer operator

Non-teaching Group C employees:

S.No.	Name	Gender	Category	Designation	Work assigned
1	Sr. R. B. Singh	Male	Gen	Office Assistant	Office Work
2	Sri O. P. Ojha	Male	Gen	Junior Office Assistant	Office Work
3	Sri Suresh Chandra Yadav	Male	OBC	Library Assistant	Library Office Work
4	Sri Shrish Kumar	Male	OBC	Junior Office Assistant	Office Work
5	Sri Ram Chandra	Male	OBC	Helper Pump Operator	Clean up Head office
6	Sri Shyam Babu	Male	OBC	Lab Attendant	Clean up Head office
7	Sri Ram Nihor	Male	OBC	Book Attendant	Carry on library books
8	Sri Ram Anjor Saroj	Male	SC	Gardner	Maintain of Garden
9	Sri Jeet Lal	Male	OBC	Library Attendant	Carry on library books
10	Sri Jawahar lal	Male	SC	Peon	Clean up Dean office

Non-teaching Group MTS employees:

S.No.	Name	Gender	Category	Designation	Work assigned
1	Sri Aditya Kumar	Male	SC	MTS	Clean up library office
2	Sri Jitendra Kumar Rawat	Male	OBC	MTS	Clean up Dean office

Details of Students, Programme wise and Reservation wise (2018-2019):

Course	Gen			OBC			SC			ST			PWD			TOTAL		
	Male	Female	Total	Male	Female	Total	Male	Female	Total	Male	Female	Total	Male	Female	Total	Male	Female	Total
Ph.D.	05	01	06	04	-	04	01	-	01	01	01	02	01	-	01	11	02	13
LL.M.	31	21	52	46	5	51	18	3	21	8	2	10	3	0	3	101	31	132
LL.B.	238	30	268	242	16	258	84	9	93	34	10	44	18	2	20	599	65	664
B.A.LL.B. (Hons) 5 yr	179	113	292	155	72	227	84	42	126	14	7	21	6	1	7	432	234	666
Total	453	165	618	447	93	540	187	54	241	57	20	77	28	3	31	1143	332	1475

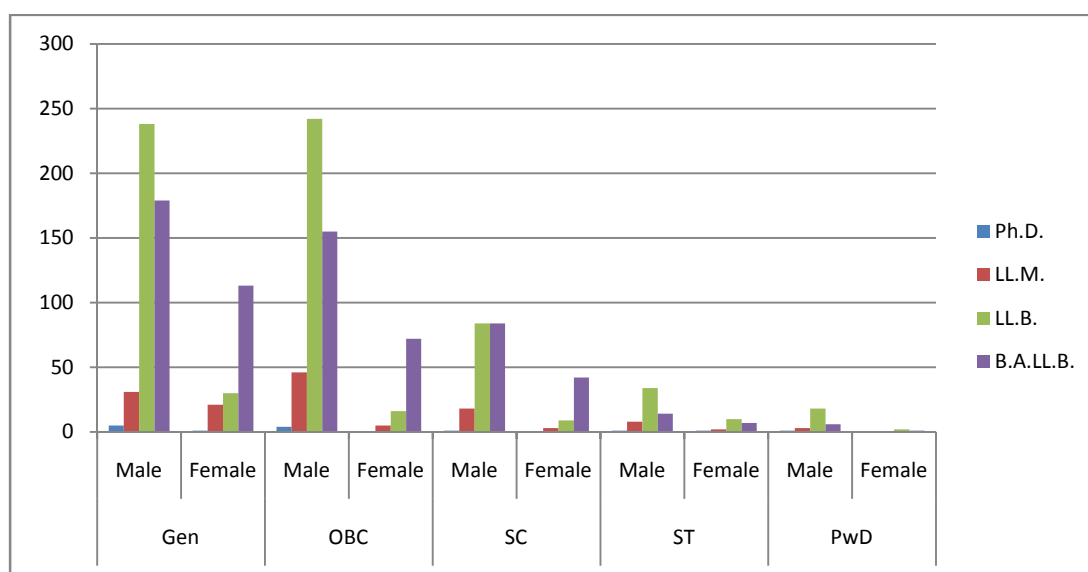

Student Enrollment for the Department

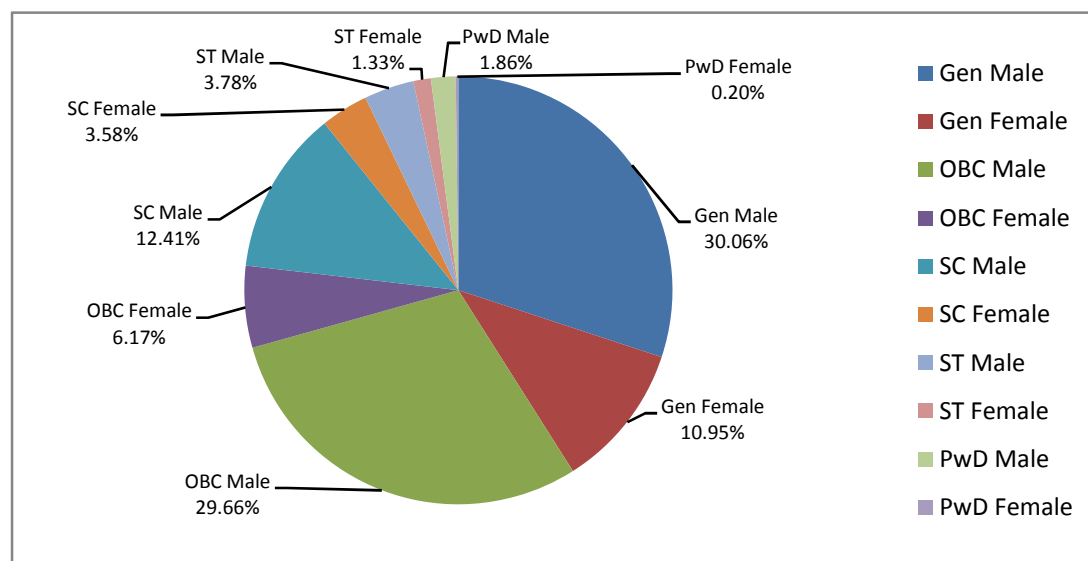

Gender wise distribution of Students

Training/Orientation/refresher courses/special lectures conducted by the Department/Centre

S.No.	Name of the course	Duration and dates	Funding/sponsor	Speakers
1.	Refresher Course	10 November 2018 to 30 November 2018	UGC	Hon'ble Justice Sudhir Agrawal Prof. Pyueesh Ranjan Agrawal Prof. Raja Ram Yadav Prof. J.S. Singh Prof. J.P. Mishra

Proposed Courses

S.No.	Name of Programme	Nature	Duration	Proposed or In process
1	Intellectual Property Rights	Certificate course	Two years	In process

Outreach activities:

S.No.	Name of Faculty member/ Student/ Researcher	Title of the paper presented	Title of Conference/ Seminar etc	Duration of the conference/ assignment	Organized by
1.	Prof. J.P. Mishra	Importance of Human Rights	Interdisciplinary Refresher course in Human Right	November 10 to 14, 2018	UGC Human Resource development centre, University of Allahabad
		Human rights jurisprudence	Interdisciplinary Refresher course in Human Right	November 10 to 30, 2018	UGC Human Resource development centre, University of Allahabad
2.	Dr. Ajai Singh	Human Rights under Indian Constitution	Human Rights Law: Prospects and Challenges	one day National Seminar	Faculty of Law CMP Degree on 22 February, 2019
3.	Dr. Abhishek Kumar	Constitutional democracy, judiciary and social justice in India : Challenges and opportunities	Instigation conference on social justice and development	23-24 February 2019	Deen Dayal Upadhyay Govt. P.G. College, Saidabad Prayagraj. U.P.
		A critical appraisal of vishakha guidelines and safety of women at workplace	National seminar on Better and fair environment for women at work place	20 January 2019	CNLU Patna
		Sedition law and freedom of right to speech and expression : A critical appraisal	National seminar on Human rights Law: Prospectus and challenges	22 February 2019	Faculty of Law, CMP degree College, Allahabad
4.	Mukta Verma	Law relating to women in India: Issues and challenges	National seminar on women willingness opportunities and challenges	7 April 2018	Institutive of Legal studies CCSU campus Merut
		Role of information technology act to intellectual property rights violations	National seminar information technology and law : Issues and challenges	21-22 April 2018	IFTM University Moradabad

FACULTY OF SCIENCE

DEPARTMENT OF BIOCHEMISTRY

Introduction:

The Department of Biochemistry was established in 1968 by the legendary Professor Dr. Radha Pant. At that time University of Allahabad was one of the few Universities in the country to start a Master's course in Biochemistry. In view of the growing importance of Biochemistry, both as a basic science as well as a broad based discipline, the Department also introduced Biochemistry at the undergraduate level in the year 2000. The Department presently offers a 3-year undergraduate program (B.Sc.) with Biochemistry as one subject, a 2-year Master's program (M.Sc. Biochemistry), and a Doctoral program (Ph.D. Biochemistry). Department organizes weekly students' seminars and frequent invited lectures by leading scientists from across the world with a view to develop quality personnel in the field of Biochemistry. In year 2018, Biochemistry department completed 50 years and celebrated Golden Jubilee year by organizing the first ever Alumni Meet and a National Conference on "Expanding Horizons of Biochemistry" on December 01, 2018. It was attended by distinct alumni from across the World.

The Department has faculty strength of eight members. The research interests of the faculty include: oxidative stress and antioxidants, xenobiotic metabolism, molecular biology of HIV-1, anti-HIV-1 drug design, toxicology, aging research and anti-aging interventions, micronutrients and their role in health, association of polymorphism with cancer and natural product based anti-microbials, hepatoprotectants and anticancer agents. The faculty is engaged in collaborative research with several institutions and universities.

Thrust Areas:

- Free radical biology and oxidative stress
- Biochemical toxicology and xenobiotic metabolism
- Ethnopharmacology and natural product biochemistry
- Molecular biology of HIV-1, anti-HIV-1 drug design
- Biochemistry of aging and anti-aging interventions
- Clinical and Nutritional Biochemistry
- Metabolic disorders & Cancer Biology
- Microbiology, Immunology and Parasitology

Programmes of Study:

S. No.	Programme of Study	Duration	No. of Seats	Specialization(s)
1.	Ph. D.	5 years (includes course work)	Variable	Biochemistry
2.	M. Sc.	2 years	22	Biochemistry
3.	B. Sc.	3 years	30	Biochemistry as one subject

Faculty members and their Area of Research:

S.No.	Name of Faculty	Designation	Area of Specialization
1.	Dr. Abhay Kumar Pandey	Professor & Head	Oxidative Stress & Free radical Biology, Toxicology, Cancer biology
2.	Dr. Bechan Sharma	Professor	Molecular Virology, Biochemical Toxicology, Enzyme Technology and Free Radical Biology
3.	Dr. Dwijendra Kr Gupta	Professor	Membrane Biology
4.	Dr. Jalaj Kumar Gour	Assistant Professor	Nutritional Biochemistry, Microbiology, Parasitology, Herbal drugs
5.	Dr. Munish Kumar	Assistant Professor	Cancer Biology
6.	Dr. Poonam C. Mittal	Professor	Psychophysiology, Clinical Biochemistry
7.	Dr. Syed Ibrahim Rizvi	Professor	Aging, Lifespan, Natural product, Redox biology
8.	Dr. Ujla Minhas	Assistant Professor	Immunology, Oxidative stress, Natural products

Support Staff:

S. No.	Name	Gender	Category	Designation	Work assigned
1.	Mr. O.P. Gupta	M	OBC	Office Assistant	Office related
2.	Mr. Dileep K. Mishra	M	Gen	Lab Attendant	Laboratory related
3.	Mr. Vijay Pal	M	OBC	Lab Attendant	Lab equipments upkeep
4.	Mr. Guddu Gour	M	OBC	Peon	Cleaning

Details of Students, Year wise and Reservation wise (2018-2019):

Course	Gen			OBC			SC			ST			PwD			TOTAL		
	Male	Female	Total	Male	Female	Total	Male	Female	Total	Male	Female	Total	Male	Female	Total	Male	Female	Total
PhD	4	10	14	9	7	16	4	1	5	0	0	0	0	0	0	17	18	35
PG	4	14	18	1	14	15	2	1	3	0	0	0	0	0	0	7	29	36
UG	8	11	19	7	11	18	3	3	6	0	1	1	0	0	18	26	44	
Total	16	35	51	17	32	49	9	5	14	0	1	1	0	0	42	73	115	

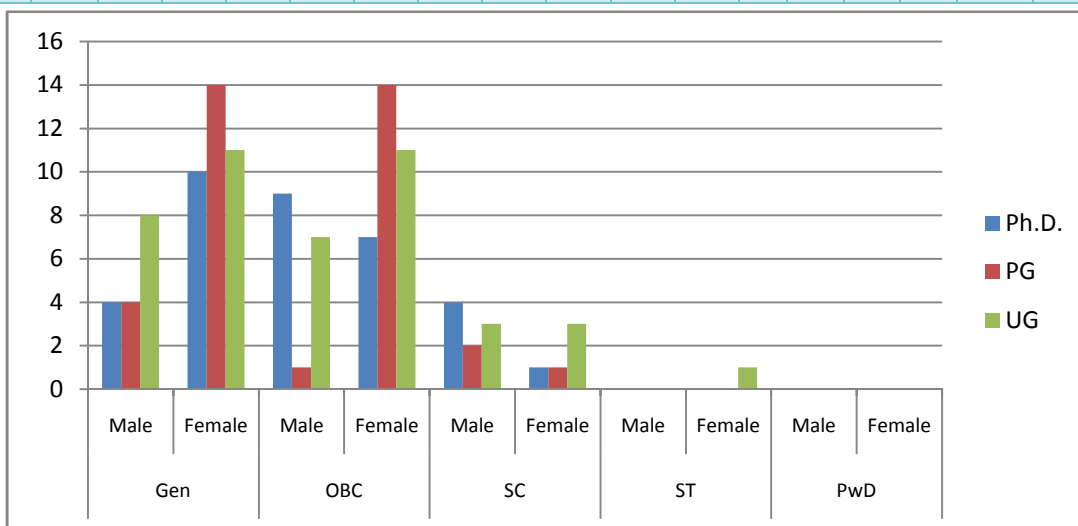

Student Enrollment for the Department

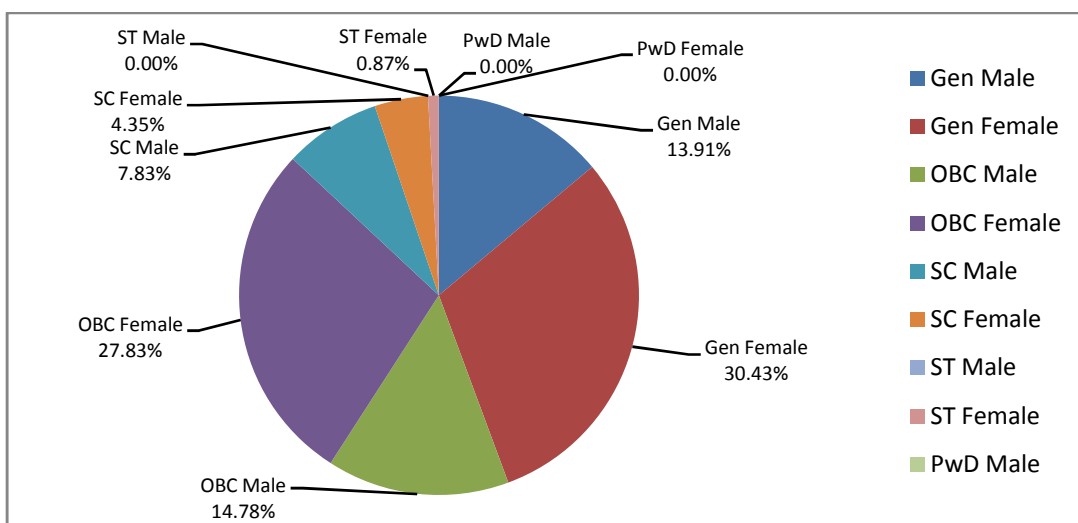

Gender wise distribution of Students

Seminars/Workshops/Conferences conducted by the Department/Centre:

S. No.	Name of the Seminar/workshop/conference	National / International	Duration and dates	Funding/sponsor Agenc(y/ies)	No. of Participants	No. of Papers presented
	Expanding Horizons of Biochemistry	National	December 01, 2018	University of Allahabad	105	40
	Alumni Meet		December 01, 2018	Department of Biochemistry, UoA	45	-

Training/orientation/refresher courses/special lectures conducted by the Department/Centre:

S. No.	Name of the course	Duration and dates	Funding/sponsor	Speakers
1.	Special lecture	September 24, 2018	Department of Biochemistry, University of Allahabad	Prof. H.S. Misra, Head, Molecular Biology Division, BARC, Mumbai
2.	Special lecture	April 12, 2018	Department of Biochemistry, UoA	Dr. Ritu Misra, NII, New Delhi

Awards/Honours/Fellowship received:

S. No.	Name of Faculty Member/Student who received award	Name of the award	Organization conferring award
1.	Prof. Abhay K. Pandey	Executive Editor- Vegetos, an International Journal of plant research & Biotechnology	SPR India/ Springer Journal
2.	Prof. Abhay K. Pandey	Associate Editor- BMC Complementary and Alternative Medicine	BioMed Central & Springer
3.	Prof. Bechan Sharma	Fellow of Bioved Research Society	Bioved Research Society-Allahabad
4.	Prof. Bechan Sharma	Life Time Achievement Award	Society of Bioinformatics and Biological Sciences-Allahabad
5.	Prof. Bechan Sharma	Conference Participation Grant (CPG) to attend APACC-2019 meeting at Tokyo, Japan	Virology Education-The Netherland
6.	Dr. Munish Kumar	Commissioned as Lieutenant, NCC Unit, Univ. of Allahabad	OTA, Kamptee, Nagpur
7.	Dr. Shambhu Sharan Tripathi	DSK-PDF	UGC
8.	Dr. Prabhask Kumar Pandey	DSK-PDF	UGC
9.	Dr. Pawan Kumar Doharey	DSK-PDF	UGC
10.	Sandeep Singh	International Travel Award for visiting Kobe, Japan	SERB-DST
11.	Sandeep Singh	International Travel Award for visiting San Diego, USA	IBRO France
12.	Geetika Garg	International Travel Award for visiting Kobe, Japan	DBT
13.	Vivek Kumar Gupta	International Travel Award for visiting Sardinia, Italy	European Society for Virology, Italy
14.	Ramesh Kumar	International Travel Award for visiting Kyoto, Japan	SERB-DST
15.	Pragati Vishwakarma	CSIR-UGC JRF	CSIR
16.	Rishabh Kumar	CSIR-UGC JRF	CSIR
17.	Harvesh Kumar Rana	CSIR-UGC NET	CSIR

Funding received during the period (amount/purpose/agency) to the Department/Centre:

S. No.	Agency	Purpose	Amount
1.	DST FIST	Strengthening infrastructure	48 Lacs
2.	UGC SAP	Strengthening infrastructure	108 Lacs
3.	Department of Biotechnology, Ministry of Science and Technology, Govt of India	National Genomics Core Grant for setting up a National Facility at University of Allahabad	20 crore six lacs eighty thousand

Other Projections:

Department of Biochemistry is coordinating with Department of Biotechnology, Ministry of Science & Technology, Government of India for establishing Research Resources, Service Facilities and Platforms (RRSFP) Programme (DBT Builders) and National Genomics Core facility in the University of Allahabad.

Outreach activities:

S. N.	Name of Faculty Member/ Student/ Researcher	Title of the paper presented	Title of Conference/Seminar etc	Duration of the conference/ assignment	Organized by
1.	Prof. A K Pandey	Invited lecture on Oxidative stress and its natural mitigators: a pharmacological relevance	National Conference on Advances in Interdisciplinary Research in Biological Chemistry	March 28-29, 2019 (2 Days)	RML University Ayodhya, India.
		Invited lecture	Central Zone ACBICON 2019	2 days	King George's Medical University, Lucknow, India.
		Invited lecture	Refresher Course	January 24, 2019.	DDU Gorakhpur University, Gorakhpur
		Convener	Alumni Meet and National Conference on "Expanding Horizons of Biochemistry"	December 01, 2018	Department of Biochemistry, UoA
		Invited talk on 'Natural products as mitigators of free radical induced oxidative stress associated pathophysiological complications'.	National Conference on Role of modern biological sciences for enhancing farmers' economy and welfare of the society',	November 12-13, 2018	RRPG College Amethi, India.
		Invited talk on 'Management of oxidative stress induced health effects by natural products'	National Conference-Central Zone ACBICON 2018 (Association of Clinical Biochemists of India)	July 21-22, 2018	King George's Medical University, Lucknow and Era University, Lucknow
		Invited talk on Current perspectives in pharmacy research	National Seminar on Current Scenario of Pharmacists in Healthcare system: A Challenge	April 13, 2018	Shambhunath Institute of Pharmacy, Allahabad, India.
2.	Ramesh Kumar	Protective effect of Callistemon lanceolatus extract in alloxan induced diabetes in albino Wistar rats	9 th Biennial Meeting of Society of Free Radical Research (SFRR-Asia 2019)	April 04-07, 2019	Kyoto International Community House (Kokaka), Kyoto,
3.	Prof. Bechan Sharma	Infidel cDNA synthesis by HIV-1RT: implications in drug resistance.	National Conference on Advances in Interdisciplinary Research in Biological Chemistry	March 28-29, 2019	Dr.RML Avadh University, Faizabad
		Application of pesticides in agricultural practices and human health	21 st National Agricultural Scientists and Farmers' Congress	February 16-17, 2019	Bioved Research Society, Sringeripur, Prayagraj.
		Heavy metals pollution in riverine systems with special reference to Kumbh	National River Conference	January 13, 2019	Kulbhaskar Degree College, Prayagraj
4.	Prof. Bechan Sharma	Association of Misinsertion and Mismatch extension by Human Immunodeficiency Virus type 1 Reverse Transcriptase with Drug Resistance	National Conference on 'Role of modern biological sciences for enhancing farmers' economy and welfare of the society',	November 12-13, 2018	RRPG-College, Amethi, UP
	Prof. Bechan Sharma	Infidel cDNA synthesis by HIV-1RT: implications in drug resistance.	National Conference on Advances in Interdisciplinary Research in Biological Chemistry	March 28-29, 2019	Dr.RML Avadh University, Faizabad

S. N.	Name of Faculty Member/ Student/ Researcher	Title of the paper presented	Title of Conference/Seminar etc	Duration of the conference/ assignment	Organized by
5.	Nitika Singh and Prof. Bechan Sharma	An <i>in vitro</i> studies on the impact of <i>Citrus limon</i> juice on the kinetic characteristics of acetylcholine esterase against lead and cartap induced perturbations	International Conference on Global Environmental Challenges Human Health and Sustainable Development at the Convention Centre,	January 11-13, 2019	JNU, New Delhi
		Studies on the combined impact of lead and cartap on the kinetic characteristics of lactate dehydrogenase from rat heart and amelioration by <i>Citrus limon</i> fruit extract	An International Conference on Emerging Issues in Agricultural, Environmental and Applied Science for Sustainable Development	December 27-29, 2018	SHUATS, Allahabad
6.	Vivek K Gupta and Prof. B. Sharma	Extract of <i>Parthenium hysterophorus</i> leaves contains anti-HIV-RT potential.	4 th Innovative Approaches for Identification of Antiviral Agents	September 24-28, 2018	International Summer School. at Santa Margherita di Pula, Sardinia, Italy.
7.	Prof. Bechan Sharma, Key Note Speaker	Molecular cloning and Gene expression.	National workshop on Genetic Engineering, Molecular cloning and Expression	Sept 13, 2018	CPM College, University of Allahabad
8.	B. Sharma, Jaiswal S K and Gupta VK	Inhibition of mammalian acetylcholinesterase by carbofuran and protection by vitamin C and Citrus limon fruit extract	Annual Congress on Medicinal Chemistry, Pharmacology and Toxicology	July 30-31, 2018 J.Org.Inorg.Chem.(2018)4; DOI: 10.21767/2472-1123-C3-009	Amsterdam, Netherland
9.	Prof. S I Rizvi	Insight into the anti-aging role of metformin: Study on naturally aged and accelerated senescence model of rats	International Conference: Interventions to extend healthspan and life span	April 22-26, 2018	Kazan, Russia
		Visiting Professor to the Institute of Heart Research, Slovak Academy of Sciences, Bratislava, Slovakia)	INSA exchange programme with Slovak Academy of Sciences	August 29-September 12, 2018	INSA, New Delhi
		Anti-aging strategies based on caloric restriction mimetics	National Conference On Recent Developments in Biomedical, Unani and Ayurvedic Translational Research	March 11-12, 2019	JN Medical College, AMU, Aligarh
10	Prof. S I Rizvi	At Technical Session IV National Seminar (Clean water, sanitation and Drug design)	Chairperson	November 28, 2019	S S Khanna Degree College, Allahabad
		Anti aging interventions: Relevance to humans	Special lecture	October 25, 2018	S S Khanna Degree College, Allahabad
11.	Sandeep Singh	Metformin as a caloric restriction mimetic provides neuroprotection against oxidative stress, apoptosis and neurodegeneration during aging	41st Annual Meeting of the Japan Neuroscience Society,	26th-29th July 2018	Kobe Convention Center, Kobe, Japan.
		Neuroprotective effects of Fisetin as a caloric restriction mimetic: Therapeutic implications during aging through the modulation of autophagy, apoptosis and neurodegeneration	Neuroscience- 2018, organized by Society for Neuroscience	3-7 November-2018	San Diego, California, USA
12.	Dr. Shambhu Sharan Tripathi	Baicalein a plant derived flavonoid improves brain aging	Symposium on "Exploring mind, brain and Behaviour"	28-29 February 2019	Amity University, NOIDA.
13.	Dr. Munish Kumar	Time and Stress management in research	Best Practices in scientific Research	One day National seminar	J K Institute of Applied Physics, UoA
		PCR and its application in biological sciences	Hands on Techniques used in Biotechnology (Core member)	17 th Dec, 2018-01 st Jan 2019	DBT, Govt. of India and UoA
14.	Dr. Jalaj Kumar Gour	Current problems and alternative for the treatment of leishmaniasis	Golden Jubilee celebration, Alumni meet & Conference on Expanding Horizons of Biochemistry	01.12.2018	Department of Biochemistry, UoA

S. N.	Name of Faculty Member/ Student/ Researcher	Title of the paper presented	Title of Conference/Seminar etc	Duration of the conference/ assignment	Organized by
15.	Sharmistha Singh	Comparative study of Biochemical Measures between Baseline and Postprandial non- diseased volunteers with respect to carbohydrate diet.	International Conference On Global Environmental Challenges Human Health and Sustainable Development	Three Days (January 11-13, 2019)	JNU, New Delhi
		Short Term Course on "In vitro Diagnostic Platforms for biomarker detection"	Short Term Course on "In vitro Diagnostic Platforms for biomarker detection"	Seven Days	MNNIT, Allahabad
16.	Astha Dwivedi	Comparative study of Biochemical Markers in Obese subjects with and without Metabolic Syndrome	International Conference On Global Environmental Challenges Human Health and Sustainable Development	Three Days (January 11-13, 2019)	JNU, New Delhi
		Short Term Course on "In vitro Diagnostic Platforms for biomarker detection"	Short Term Course on "In vitro Diagnostic Platforms for biomarker detection"	Seven Days	JNU, New Delhi
17.	Sandeep Kumar	Impact of Nicotine on Oxidative Stress, Coping and Perceived Stress	International symposium on Recent trends in agriculture, Biodiversity and social Sustainability (ABSS 2018)	Two Days	Botanical Survey of India (BSI) Allahabad, U.P., India
		Effect of Nicotine addiction on Perceived Stress, Coping efficacy and Oxidative Stress Indices	International Conference On Global Environmental Challenges, Human Health and Sustainable Development	Three Days (January 11-13, 2019)	JNU, New Delhi
		Short Term Course on "In vitro Diagnostic Platforms for biomarker detection"	Short Term Course on "In vitro Diagnostic Platforms for biomarker detection"	Seven Days	JNU, New Delhi
18.	Risha Ganguly	Hepatoprotective effect of cinnamaldehyde in food colour induced toxicity in rat model	International Conference on Global Environmental Challenges, Human Health and Sustainable development	Three days (January 11-13, 2019)	JNU, New Delhi
19.	Ramesh Kumar	Antidiabetic activity of Callistemon	Indian Science Congress	Five days (January 03-07, 2019)	LPU, Jalandhar, Punjab
		Science Exhibition Programme	Vigyan Prasar, DST	Seven days (Feb 02-08, 2019)	Kumbh Mela, Prayagraj
20.,	Ashutosh Gupta	Mitigation of paracetamol induced liver injury by T. bellerica fruit extracts in rats	88 th Annual Session of National Academy of Sciences	Three days (December 06-08, 2019)	MG Chitrakoot Gramodaya Vishwavidyalaya, Chitrakoot

Other information (about the Department/Center)

Biochemistry Department Celebrated Golden Jubilee Year by organizing An Alumni Meet cum Conference on December 01, 2018

The Department of Biochemistry, University of Allahabad feels proud to have completed 50 years of its inception since 1968. To mark the Golden Jubilee Celebrations, the first ever Alumni Meet and a Conference on "Expanding Horizons of Biochemistry" was organized by the department on December 01, 2018 in DD Pant Auditorium of the Botany Department. About fifty alumni from India and abroad participated. Prof. Abhay Kumar Pandey, Head of the Department & Convener of the Meet welcomed the guests and presented in brief the account of the Department of Biochemistry. The Vice-Chancellor of Chandra Shekhar Azad University of Agriculture and Technology Kanpur Prof. S. Solomon, an alumnus of the department (1972-74 batch) presided over the function.

- One Foreign student (Mohammed Abubakar from Nigeria) was awarded PhD degree during current year while one more foreign student (Manoj Chaudhary from Nepal) is working as PhD student in the Department of Biochemistry.
- During Session 2018-19 University has given approval to start B.Sc. Biochemistry course in Ishwar Saran Degree College, Prayagraj

Two research papers from Biochemistry department have received highest Google Scholar Citations till date. Details are given below.

Article	Year of Publication	No. of citations (Google Scholar)
Kumar S. and Pandey A.K. Chemistry and Biological Activities of Flavonoids: An Overview. The Scientific World Journal, 2013: Article ID 162750. 16 pages, Doi: 10.1155/2013/162750.	2013	1526
Pandey K.B. and Rizvi S.I. Plant polyphenols as dietary antioxidants in human health and disease. Oxidative Medicine and Cellular Longevity 2 (5): 270-278.	2009	1993

Photographs of Departmental events



Dr. H.S. Misra, Head, Molecular Biology Division, BARC, Mumbai delivered a special lecture on 24.09.2018



Chief Guest Prof. S. Solomon, Vice Chancellor, CSA University of Agri. & Tech Kanpur addressing the Alumni Meet and Conference



Group Photograph of Biochemistry Alumni Meet



Prof. Babita Agrawal, University of Alberta, Canada delivering lecture on Immune system and interacting with students and faculty members



Dr. Santosh Verma, NIH- Bathedsa, USA, delivering a lecture (Feb 02, 2018).

DEPARTMENT OF BOTANY

Introduction:

Department of Botany is a well known department of University of Allahabad. The Department of Botany which was earlier a part of Biology Department of Muir Central College started as a separate entity in the year 1923, with Dr. J.H Mitter as the founder Head of the Department. Now the department has completed 94 years of its glorious existence under the stewardship of eminent botanists like Prof. S.Ranjan, FNI, Prof. R.K.Saxena, FNI, Prof. R.N. Tandon, FNA, Dr. A.K. Mitra and Prof. D.D. Pant, FNA and others who have adorned the professorial chair of the department. All of them maintained the great tradition of excellence in research and teaching. The department is known for multidisciplinary character and has earned international recognition for its standard of teaching and research producing eminent scholars and administrators, who have occupied or occupying high positions in and outside the country. In recognition of its academic excellence, the department of botany was awarded two prestigious programmes by the UGC 1- The special assistance programme (1976) 2- The COSIST support programme (1990).

- ❖ **Roxburgh botanical garden and Experimental farm-** The department is maintaining perhaps the best botanical garden in the country which is famous for the rich collection of rare Pteridophytes, Gymnosperms and Angiosperms. It is maintaining the best collection of rare Cycads and Conifers. Besides these garden is also maintaining some rare and endangered plants of Pteridophyte and Angiosperm. The avenue of bottle palms and panels of different plant give panoramic view to the garden.
- ❖ **Agharkar Museum-** The department has a Botanical Museum which is located on the first floor of east wing of the botany department. The museum is named after Dr. S.P. Agharkar, whose name figures among the legendary botanist of the country. The museum is well known for its rare collection of living and fossil plant belonging to different plant groups from Algae to Angiosperm.
- ❖ **Duthie Herbarium-** The department is maintaining the best collection of herbarium plants of various groups like Bryophytes, Pteridophytes,
- ❖ Gymnosperms and Angiosperms. It includes the rare prized collection of Duthie, King, Kustler, Dudgeon, Cave, Wallich and Gamble. There are nearly 25000 specimens. It has also the rich flora of different districts of UP.

Thrust Areas:

- Palaeobotany, Morphology and Anatomy
- Plant Pathology including Microbiology
- Plant Physiology

The laboratories are well equipped with latest instruments.

There are other areas of interest like Taxonomy, Bio-diversity, Palynology, Ecology, Cytogenetics and molecular Biology which are also attaining excellence.

Programmes of Study:

S. No.	Programme of Study	Duration	No. of Seats
1.	Ph.D.	5 years (includes course work)	11 (Bot.), 01 (Ag.Bot.), 04 (Env.Sc.)
2.	M. Sc. Botany	2 years (4 semesters-CBCS pattern)	62
3.	M. Sc. Evs	2 years (4 semesters-CBCS pattern)	31
4.	M. Sc. Ag	2 years (4 semesters-CBCS pattern)	15
5.	B. Sc.	3 years	240

Faculty members and their Area of Research:

S.N.	Name of Faculty	Designation	Area of Specialization
1.	Dr. Anupam Dikshit	Professor	Microbiology, Plant Pathology and Angiosperm Taxonomy
2.	Dr. D.K. Chauhan	Professor and Head	Evolutionary Botany, Stress Physiology

S.N.	Name of Faculty	Designation	Area of Specialization
3.	Dr. Dinesh Kumar Yadav	Assistant Professor	Molecular Biology& Genetic Engineering
4.	Dr. Girjesh Kumar	Professor	Genetics & Plant Breeding
5.	Dr. Harbans Kaur Kehri	Professor	Mycology, Plant Pathology, Microbiology
6.	Dr. K. Suresh Kumar	Assistant Professor	Phycology & Algal Physiology
7.	Dr. Kumar Suranjit Prasad	Assistant Professor	Environmental Biotechnology, Remediation Etc.
8.	Dr. Narsingh Bahadur Singh	Professor	Plant Physiology, Ecology, Crop Physiology
9.	Dr. Pawan Kumar Jha	Assistant Professor	Environmental Biogeochemistry
10.	Dr. Rajiv Kumar Yadav	Assistant Professor	Molecular Biology& Genetic Engineering
11.	Dr. S.C. Agarwal	Professor	Limnology, Phycology, Marine Biology
12.	Dr. Satya Narain	Professor	Plant Taxonomy, Economic Botany
13.	Dr. Sheo Mohan Prasad	Professor	Physiology, Biochemistry & Molecular Biology

Support Staff:

S. No.	Name	Gender	Category	Designation	Work assigned
1.	Mr. Bishan Singh	M	GEN	Sr.Tech. Asstt.	Arrangements related to practical classes/ exams, store
2.	Mr. Jagdish Chandra	M	GEN	Tech. Asstt.	„
3.	Mr. Chandra Prakash Joshi	M	GEN	Tech.Asstt.	„
4.	Mr. Akhil Agarwal	M	GEN	Lab. Asstt.	Practical, museum
5.	Mr. Rajesh Kumar Kashyap	M	OBC	Office Asstt.	All the works related to office
6.	Mr. BrajKishor Tiwari	M	GEN	Jr. Office Asstt.	Work related with research BOS enrollment of UG
7.	Mr. Awadhesh Kumar	M	GEN	Library Asstt.	Library work
8.	Mr. Shashi Prakash	M	OBC	Carpenter	Minor works as carpenter.
9.	Mr. Santosh Babu Mishra	M	GEN	Photo Artist	Ph.D.. viva voce,exam., Lectures T.A & Auditorium related work
10.	Mr. Brijesh Kumar	M	OBC	Mechanic	Driver
11.	Mr. Ram Babu Kushwaha	M	OBC	Tube well operator	All the electric works of the Department
12.	Mr. Raj Mangal Tiwari	M	GEN	Lab. Attendant	M.Sc. Lab
13.	Mr. RadheyShyam S/O Ram Lal	M	OBC	Lab. Attendant	Issuing Books to students.
14.	Mr. Virendar Kumar Maurya	M	OBC	Lab. Attendant	Help in Practical classes
15.	Mr. Shiv Shankar	M	OBC	Lab. Attendant	Help in Practical classes
16.	Mrs. Soma Tiwari	F	GEN	Peon	Looks after girl's common hall
17.	Mr. Ashok Kumar Maurya	M	OBC	Peon	glasswares, chemicals and lab works.
18.	Mr. Ganiko Prasad Kushwaha	M	OBC	Peon	Work related with Head's chambers & practical classes of M.Sc I & II sem.
19.	Mr. RadheyShyam	M	OBC	Mali	Maintenance of garden
20.	Mr. Ram Lal	M	OBC	Mali	Maintenance of garden
21.	Mr. Umesh Chandra Mishra	M	GEN	Mali	Work related to office
22.	Mr. Dirgaj Prasad	M	OBC	Mali	Maintenance of garden
23.	Mr. Kamaljeet	M	SC	Sweeper	Cleaning the lab, lecture theater etc.
24.	Sanno Begum	F	OBC	Sweeper	To clean the laboratory and Auditorium

Details of Students, Programme wise and Reservation wise (2018-2019):

Course	Gen			OBC			SC			ST			PwD			TOTAL		
	Male	Female	Total	Male	Female	Total	Male	Female	Total	Male	Female	Total	Male	Female	Total	Male	Female	Total
Ph.D.	4	4	8	2	3	5	2	2	4	0	0	0	0	0	0	8	9	17
PG	33	41	74	24	13	37	9	12	18	6	2	5	0	0	0	72	65	92
UG	77	119	196	99	92	191	51	60	111	10	8	18	0	0	0	237	279	516
Total	114	164	278	125	108	233	62	74	133	16	10	23	0	0	0	317	353	625

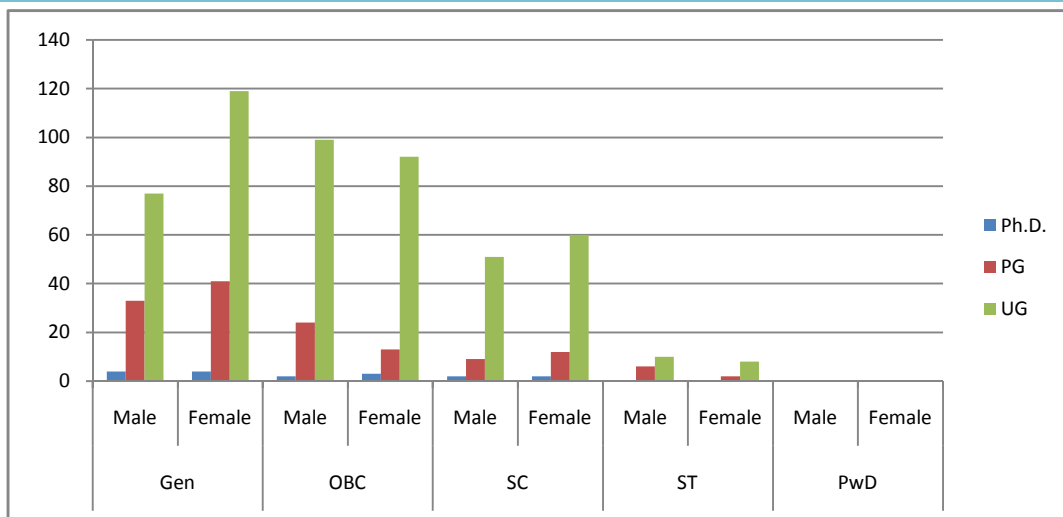

Student Enrollment for the Department

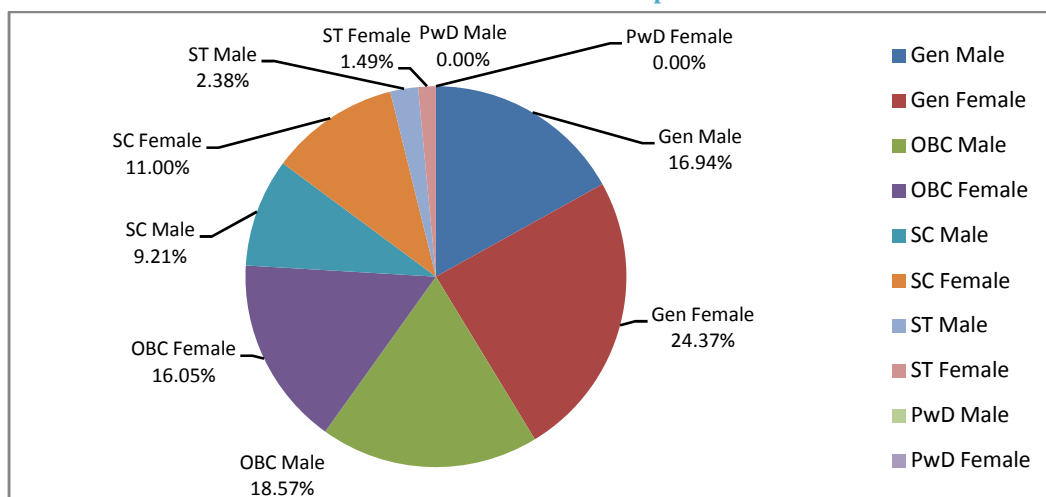

Gender wise distribution of Students

Funding received during the period (amount/purpose/agency) to the Department

S. No.	Agency	Purpose	Amount
1.	DST FIST programme	Upgradation and advancement of departmental UG, PG courses and research work	Rs 95,000,00

DEPARTMENT OF CHEMISTRY

Introduction

The Department of Chemistry is one of the oldest and most prominent departments of the University of Allahabad. It started functioning in 1872 under the principal ship of Prof. Harrison, who took keen interest in the development of this department. Prof Hill was responsible for managing the teaching of Chemistry. This department earned significant popularity on national/international scenario under the able guidance of Pro. N.R. Dhar, I.E.S. He was a distinguished scholar and pioneer researcher in the field of Physical Chemistry, Inorganic Chemistry and Soil Sciences. He served as Head of the Department from 1922-1938 and 1946-1953. The rich traditions set by Prof. Dhar were successfully executed by his successors Prof. S.Ghosh and Prof. Satya Prakash and hoard of other brilliant teachers, who contributed to develop the Department into centre of high learning. Encouraged by the past glory, the department is striving hard to create a niche for itself in national and international domains of teaching and research. As a result it was selected as a Centre for Special Assistance by U.G.C. in 1978, selected for an aid under COSIST in 1996.

The Department's vision is to promote excellence in Chemistry education and its mission is to blend theoretical knowledge of Chemistry with practical skills.

Thrust Areas:

- Chemical Kinetics
- Synthetic Organic Chemistry
- Co-ordination Chemistry
- Drug Designing & Medicinal Chemistry
- Anti-HIV drug development
- Quantum Mechanics
- Soil Chemistry
- Environmental Chemistry, Polymer & Material Chemistry
- Nano Science Technology

Programmes of Study:

S. No.	Programme of Study	Duration	No. of Seats	Specialization(s)
1.	Ph.D.	5 years (includes course work)	16 2	Chemistry & Agricultural Chemistry
2.	M. A./M. Sc.	2 years	108	-
3.	B. A./B. Sc.	3 years	-	-

Faculty members and their Area of Research:

S.N.	Name of Faculty	Gender	Designation	Area of Specialization
1.	Dr. Dinesh Mani	Male	Professor	Agricultural Chemistry and Soil Science
2.	Dr. Geeta Watal	Female	Professor	Medicinal and Nucleic Acid Chemistry
3.	Dr. Ibadur Rahman Siddiqui	Male	Professor	Natural Products, Organic Synthesis
4.	Dr. Jagdamba Singh	Male	Professor	Natural Products & Synthetic Organic Chemistry
5.	Dr. Krishna Srivastava	Female	Professor & Head	Co-ordination Chemistry, Electrochemistry
6.	Dr. Praveen Kumar Tandon	Male	Professor	Chemical Kinetics, Organic Synthesis and Catalysis by Nanoparticles, Water Pollution and Conducting Polymers.
7.	Dr. Ramendra Kumar Singh	Male	Professor	Nucleic Acid Chemistry and Molecular Biology
8.	Dr. Rana Krishna Pal Singh	Male	Professor	Co-ordination Chemistry, Electro-organic Synthesis

S.N.	Name of Faculty	Gender	Designation	Area of Specialization
9.	Dr. Shekhar Srivastava	Male	Professor	Photoelectron Spectroscopy, Organometallic Chemistry and Co-ordination Chemistry, Polymers/Biopolymers, Nanocomposites,
10.	Dr. Vandana Singh	Female	Professor	Macromolecular Materials and their Applications

Support Staff:

S. No.	Name	Gender	Category	Designation	Work Assigned
1.	Mr. Hare Krishna Dwivedi	Male	GEN	Tech. Asstt.	Lab Work
2.	Mr. Ratnesh Kumar Shukla	Male	GEN	Tech. Asstt.	Lab Work
3.	Mr. Anoop Kumar Bose	Male	GEN.	Tech. Asstt.	Office
4.	Mr. Arvind Kumar Pandey	Male	GEN	Tech. Asstt.	Lab Work
5.	Mr. Sambhu Nath Pramanik	Male	GEN	Lab. Asstt	Glass Blower
6.	Mr. Sanjay Sinha	Male	GEN	Mechanic	Mechanic
7.	Mr. Sanjay Agarwal	Male	GEN	Mechanic	Mechanic
8.	Mr. Syed Raza Hasnain Rizvi	Male	GEN	Office Asstt.	Office Work
9.	Mr. Rajneesh Kumar Gupta	Male	GEN	Jr. Office Asstt./ Store Keeper	Store Work
10.	Mr. Sant Lal Tripathi	Male	GEN	Jr. Office Asstt.	Office Work
11.	Mr. Ram Babu Yadav	Male	OBC	Jr. Office Asstt.	Office Work (Libraian)
12.	Mr. Harish Chandra	Male	OBC	Helper Carpenter	Carpenter
13.	Mr. Amarnath	Male	OBC	Lab Attend.	Research Lab Work
14.	Mr. Ram Sunder	Male	OBC	Lab Attend.	Research Lab Work
15.	Mr. Naushad Alam	Male	OBC	Lab Attend.	Lab Work
16.	Mr. Ishrat Ali	Male	OBC	Lab Attend.	Lab Work
17.	Mr. Krishna Bahadur	Male	OBC	Lab Attend.	Lab Work
18.	Mr. Hori Lal	Male	SC	Gas Coolie	Lab Work
19.	Mr. Shambhu Lal	Male	OBC	Gas Coolie	Office
20.	Mr. Chhotey Lal	Male	OBC	Lab Attend.	Lab Work
21.	Mr. Sunil Kumar	Male	OBC	Lab Attend.	Lab Work
22.	Mr. Lalta Prasad	Male	OBC	Lab Attend.	Lab Work
23.	Mr. Prahalad	Male	OBC	Lab Attend.	Lab Work
24.	Mr. Sudhir Kumar	Male	OBC	Gas Coolie	Lab Work
25.	Mr. Subhash Kumar Yadav	Male	OBC	Lab Attend.	Office Work
26.	Mohd. Jalil Ansari	Male	OBC	Lab Attend.	Office Work
27.	Mr. Rama Shankar Mishra	Male	GEN	Pump Opetator	Lab Work
28.	Mr. Rajesh Kumar	Male	OBC	Lab Attend.	Lab Work
29.	Mr. Rakesh Kumar	Male	OBC	Peon	Lab Work
30.	Mr. Mool Chandra	Male	OBC	Lab Attend.	Lab Work
31.	Mr. Bharat Lal	Male	OBC	Lab Attend.	Lab Work
32.	Mr. Phool Chandra	Male	SC	Sweeper	Sweeper
33.	Mr. Shiv Shankar Maurya	Male	OBC	Peon	Office
34.	Mr. Manmohan Mishra	Male	GEN	Office Aasiatant	Office Work
35.	Mr. Rameshwar Ram	Male	OBC	Lab Attend. Retired In June 2018	Research Lab Work

Details of Students, Programme wise and Reservation wise (2018-2019):

Course	Gen			OBC			SC			ST			PwD			TOTAL		
	Male	Female	Total	Male	Female	Total	Male	Female	Total	Male	Female	Total	Male	Female	Total	Male	Female	Total
Ph.D.	-	-	-	-	-	-	-	-	-	-	-	-	-	-	-	44	21	65
PG	51	29	80	72	22	94	28	7	35	3	1	4	-	-	5	154	59	252
UG	287	138	425	354	172	526	131	62	193	38	11	49	-	-	22	810	382	1215
Total	338	167	505	426	194	620	159	69	228	41	12	53	-	-	27	1008	462	1470

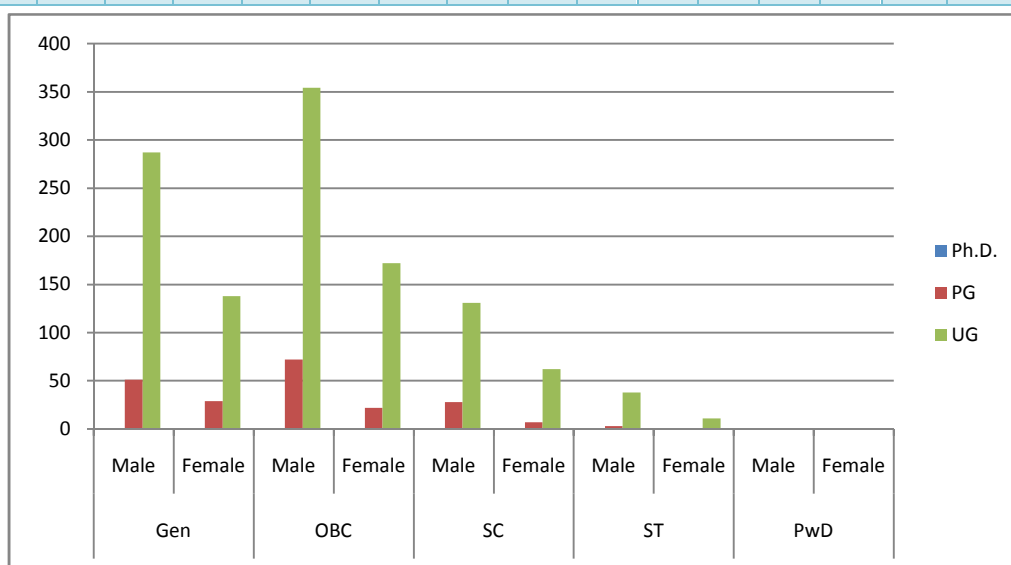

Student Enrollment for the Department

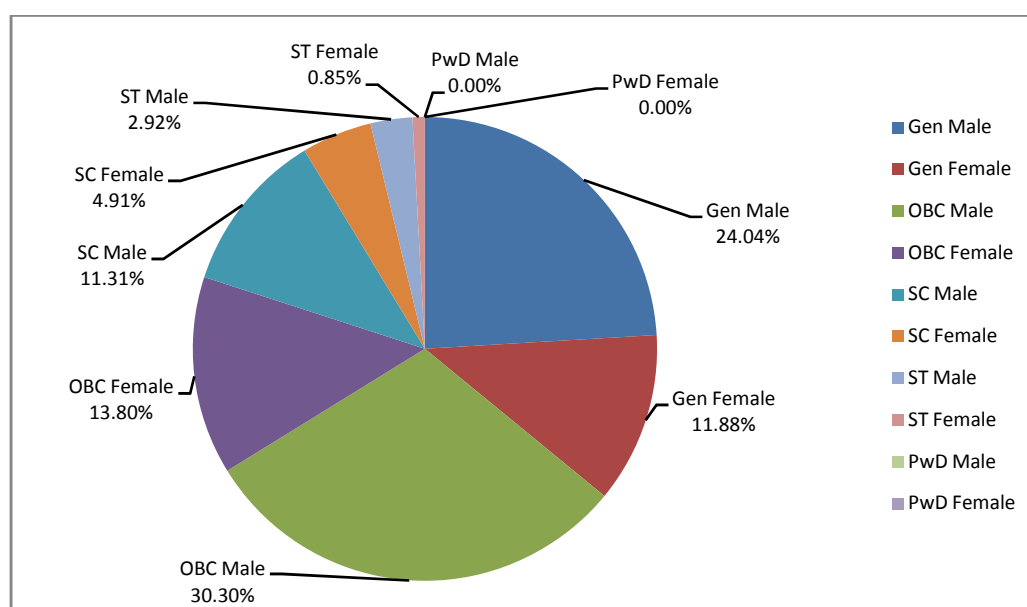

Gender wise distribution of Students

Seminars/Workshops/Conferences conducted by the Department/Centre:

S. No.	Name of the Seminar/workshop/conference	National / International	Duration and dates	Funding/sponsor Agenc(y/ies)	No. of Participants	No. of Papers presented
1.	Indian Science Congress Allahabad Chapter	National	3 Days. 22-24th	Indian Science Congress	300	130

Awards/Honours/Fellowship received:

S.No.	Name of Faculty Member/Student who received award	Name of the award	Organization conferring award
1.	Fatima Tufail	Young Scientist	Indian Science Congress, 2019
2.	Prof. J. Singh	UGC-BSR Fellowship	UGC, New Delhi
3.	Prof. Geeta Watal	UGC-BSR Fellowship	UGC, New Delhi



In Inaugural session, the souvenir and abstract of national conference of Indian Science Congress Allahabad Chapter, organized by chemistry department have been released on 22-24th February 2019.



Indian Science Congress, Young Scientist Award 2019 received by Fatima Tufail (Research Scholar- SRF)

DEPARTMENT OF DEFENCE AND STRATEGIC STUDIES

Introduction:

The Dept. of Defence and Studies established in 1940 has assumed enormous significance in the modern day world and more so in the era of Globalization. This area of study is not only up coming in India but also has become highly relevant for students, researchers, academics and policy makers. The Department will strive to provide a dedicated programme of study for higher education and research.

Thrust Areas:

1. To function as a dedicated think tank and research centre for National Security Studies with a focus on the Southern Asian region. It would concentrate on the developments in the region and would disseminate information's related to India's Defence and National Security.
2. The Department brings out well researched and authenticated Occasional papers by the Research personnel's in the field, faculty Members of the Department and eminent experts in the field of National Security which are sent to National Institutions and Libraries.
3. The Department will periodically organize Seminars, Conferences, Workshops, Symposiums, Panel Discussions, Invited Lectures and Refresher Courses
4. An Annual Journal entitled "Indian Journal of Security Studies" is being published where along with the Scholars in the field, faculty members in the dept. and invited articles from experts are published.
5. The Department maintains linkages with the recognised institutions for cross research and Joint Collaboration to enhance the scope of teaching and research on Defence and National Security issues and concerns.

Programmes of Study:

S.No.	Programme of Study	Duration	No. of Seats	Specialization(s)
1.	Ph.D	3- 5 years	05	defence & strategic studies
2.	M. A./M. Sc.	2 years (4 Semesters)	23+ 5(Armed Forces Personnel)	
3.	B. A./B. Sc.	3 years	587+87=688 (Male +Female)	Not Required

Faculty members and their Area of Research:

S.No.	Name of Faculty	Designation	Area of Specialization
1.	Dr. Bharti Das	Professor	Legal Aspects of International Relations
2.	Dr. Madhvendra Nath Varma	Professor	Guerilla Warfare
3.	Dr. Prashant Agarwal	Professor	Science Technology & National Security
4.	Dr. Raj Kumar Upadhyaya	Professor	Military History
5.	Dr. Sanjeev Bhadauria	Professor	International Relations; Peace & Conflict Studies
6.	Dr. Shekhar Adhikari	Professor	Strategic Thought

Support Staff:

S. No.	Name	Gender	Category	Designation	Work assigned
1.	Chandra Dutt Pandey	Male	General	Office Assistant	Office Related
2.	Ajay Kumar Srivastava	Male	General	Technical Assistant	Lab Related

Details of Students, Programme wise and Reservation wise (2018-2019):

Course	Gen			OBC			SC			ST			PwD			TOTAL		
	Male	Female	Total	Male	Female	Total	Male	Female	Total	Male	Female	Total	Male	Female	Total	Male	Female	Total
Ph.D	27	02	29	11	05	16	05	0	05	0	-	-	-	-	-	43	07	50
PG	20	03	23	10	06	16	08	01	0	0	-	-	-	-	-	38	10	48
UG	235	44	279	187	36	223	110	39	149	5	-	5	-	-	-	537	119	656
Total	282	49	331	208	47	252	123	40	154	5	-	5	-	-	-	618	136	754

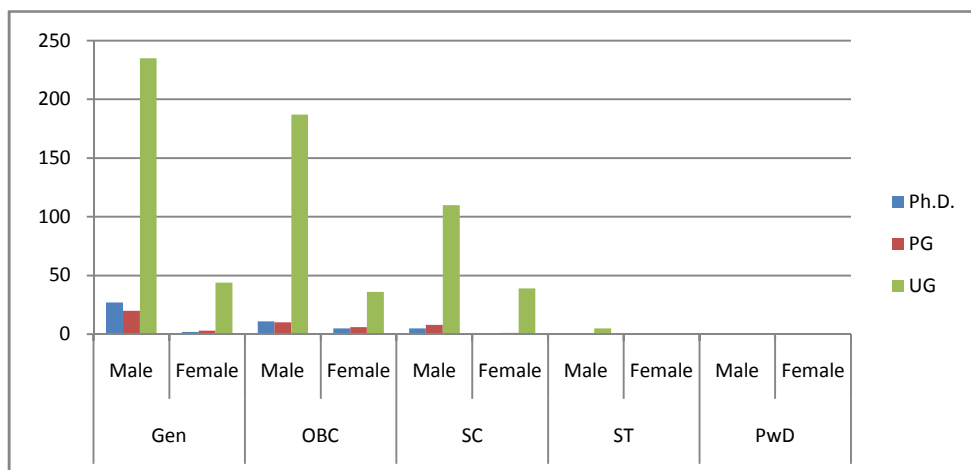

Student Enrollment for the Department

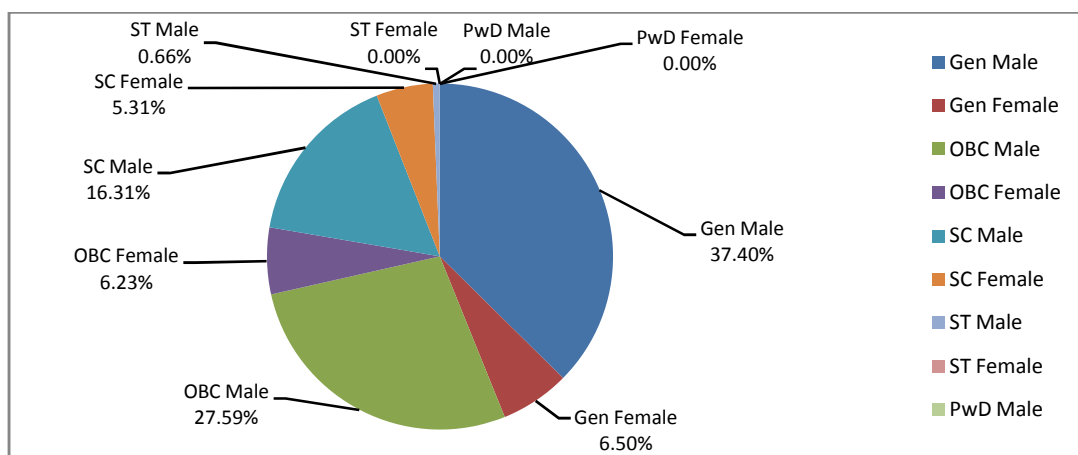

Gender wise distribution of Students

Funding received during the period (amount/purpose/agency) to the Department/Centre:

S.No.	Agency	Purpose	Amount
1.	University Grants Commission Special Assistance Programme (SAP) DRS II	Books, Seminar and Research related activities	56 Lakh + 1 Project Fellow (Funds not transferred as yet)

Academic Organizations (headquartered in the department/Centre):

S.No.	Name	Nature	Objectives
1.	National Congress for Defence Studies (NCDS)	National	<ul style="list-style-type: none"> To provide a national forum for the promotion and integrated development of Defence and Strategic Studies. To function as a platform for the interaction and interchange of ideas among the members of NCDS, national and international scholars & analyses in the field of Defence and Strategic Studies. to function as a 'centre of information' with regards to Defence and Strategic Studies Literature and a 'think tank' on Security affairs. To publish research Monographs, Journals and other publication in the field of Defence and Strategic Studies. To hold Symposia, Seminars, Congresses and Conferences on relevant

S.No.	Name	Nature	Objectives
			and contemporary National and International Strategic issues and themes.
2.	Society for Peace, Security & Development Studies (SPSDS)	National	<ul style="list-style-type: none"> To publish research Monographs, Journals and other publication in the field of Peace, Security & Development Studies. To hold Workshops, Seminars and Conferences on relevant and contemporary National and International issues and themes related to Peace, Security & Development Studies.
3.	Peace Research Society (PRC)	National	To publish research Monographs, Journals and other publication in the field of Peace and Conflict Studies.

Journals published by the Department:

S.No.	Title	Nature	Established	Annual/bi-annual /quarterly	ISSN
1.	Indian Journal of Strategic Studies (IJSS)	National	1980	Annual	0973-9386
2.	Journal of Peace, Security & Development	National	1985	Annual	0976-1551
3.	<i>Raksharth</i>	National	1996	Annual	2229-6069

Proposed Courses

S.No.	Name of Programme	Nature	Duration	Intake of Students	Remarks
1.	Postgraduate Diploma (Semester System)	National Security, Disaster Management & Defence Journalism/ Diploma	One year	15 (5 for Armed forces Officers)	Subject to Sanction
2.	Short term capsule courses for security personnels	Internal Security/ Training	4-6 weeks	40 (Para-military & Armed forces Officers)	Subject to Sanction

Other Projections:

Consequent upon the need to upgrade the existing departments of Defence & Strategic Studies to focus more on National Security Studies, the Department wishes to take a lead and proposes a **Centre for National Security Studies** as well.

Outreach activities

S.N.	Name of Faculty Member/Student/ Researcher	Title of the paper presented	Title of Conference/ Seminar etc	Duration of the conference/ assignment	Organized by
1.	Bhadauria, S.	'The Challenge of Terrorism in India with special reference to Pulwama Attack'	123rd Orientation Programme for University and College Teachers	March 2, 2019	UGC Human Resource Development Centre, University of Allahabad, Allahabad
		'Keynote Address'	National Seminar on "Terrorism: India's Security"	March 1, 2019	Shambhunath Institute of Law, Allahabad
		'Keynote Address'	National Seminar on "Disaster Management in India"	December 07, 2018	Arya Kanya Girls P G College, Allahabad (UP)
		'Keynote Address'	National Seminar on "Challenges to India's Security"	October 13-14, 2018	K S Saket P G College, Faizabad (UP)
		'Energy and Environmental Security'	121st Orientation Programme for University and College Teachers	October 10, 2018	UGC Human Resource Development Centre, UoA
		'Left Wing Extremism in India and its Implications'	120th Orientation Programme for University and College Teachers	August 4, 2018	UGC Human Resource Development Centre, UoA
		'Trends in India-China Relations'	119th Orientation Programme for University and College Teachers	April 17, 2018	UGC Human Resource Development Centre, UoA
2.	Upadhyaya R. K.	India's Security Perspective in South Asia	120th Orientation Programme for University and College Teachers	August 6, 2018	UGC Human Resource Development Centre, UoA

DEPARTMENT OF EARTH & PLANETARY SCIENCES

Introduction:

Department of Earth and Planetary Sciences (DEPS) was established in the year 1985. It is FIST-sponsored Level-II department recognized by the Department of Science and Technology, Govt. of India. The DEPS is known for its scientific contributions in frontier areas of research in Earth and Planetary Sciences in India and abroad. Our alumni are serving as faculty members and research scientists in top-rated institutions in India like IITs, IISER, JNU, BHU, PRL etc. and in abroad like NASA (USA), Kio University (Tokyo, Japan). Our students are also performing exceptionally well in various professional organizations like GSI, AMD, ONGC, MECL, CIL, CGWB, NHPC, Indian Oil, NTPC, Reliance Petroleum, UPDGM, Essar Oil, SHELL, Schlumberger etc. Every year our students perform very well in national level entrance examinations (GATE and UGC-CSIR NET) for admission in M.Tech. and research courses.

Thrust Areas:

- Sedimentology
- Geo-exploration
- Micropaleontology
- Remote sensing and GIS
- Seismic coda wave attenuation
- Seismic hazard analysis
- Engineering Geology and Rock mechanics
- Environmental Impact Assessment and Management
- Experimental Petrology and Impact cratering research

Programmes of Study:

S.No.	Programme of Study	Duration	No. of Seats	Specialization (s)
1.	Ph.D.	5 years (includes course work)	06	---
2.	M. Sc.	4 semester (2years)(CBCS)	15	Applied Geology
3.	B. Sc.	3 years	38	Not Required

Faculty members and their Area of Research:

S.No.	Name of Faculty	Gender	Designation	Area of Specialization
4.	Dr. Ajai Kumar Rai	Male	Professor	Micropaleontology
3.	Dr. Jayant Nath Tripathi	Male	Professor	Geo-exploration, Seismic hazard analysis, seismic wave propagation in heterogeneous media
2.	Dr. Jayanta Kumar Pati	Male	Professor	Experimental Mineralogy & Petrology, Terrestrial Impact Cratering Research, and Geology of Bundelkhand craton
7.	Dr. Prakash Kumar Singh	Male	Assistant Professor	Rock Mechanics and Engineering Geology
5.	Dr. Priyamvada Singh	Female	Assistant Professor	Seismology, Remote Sensing, Environmental Geology, Geo- exploration
6.	Dr. Ravindra Pratap Singh	Male	Assistant Professor	Environmental Geology and Neo-tectonics
1.	Dr. Siddhartha Sankar Das	Male	Professor and Head	Sedimentology and Paleoclimatology

Support Staff:

S.No.	Name	Gender	Category	Designation	Work assigned
1.	Mr. Garun Kumar Mishra	Male	GEN	Office Assistant	Office work

S.No.	Name	Gender	Category	Designation	Work assigned
2.	Mr. Sitaram Yadav	Male	OBC	Lab Assistant	Lab, Library work
3.	Mr. Jatan Lal	Male	SC	Lab Attendant	Lab. work
4.	Mr. Vidhya Nath	Male	GEN	Peon	Dept. work

Details of Students, Year wise and Reservation wise (2018-2019):

Course	Gen			OBC			SC			ST			PwD			TOTAL		
	Male	Female	Total	Male	Female	Total	Male	Female	Total	Male	Female	Total	Male	Female	Total	Male	Female	Total
Ph.D.	-	1	1	-	-	-	1	-	1	-	-	-	-	-	-	1	1	2
PG	5	2	7	10	4	14	1	1	2	-	-	-	-	-	-	16	7	23
UG	18	5	23	20	8	28	11	3	14	1	-	1	-	-	-	50	16	66
Total	23	8	31	30	12	42	13	4	17	1	-	1	-	-	-	67	24	91

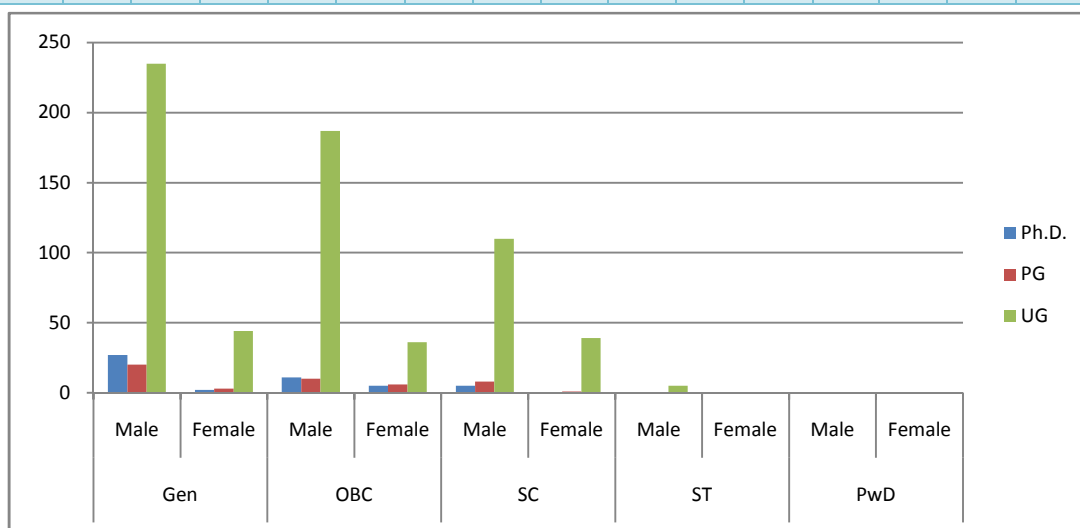

Student Enrollment for the Department

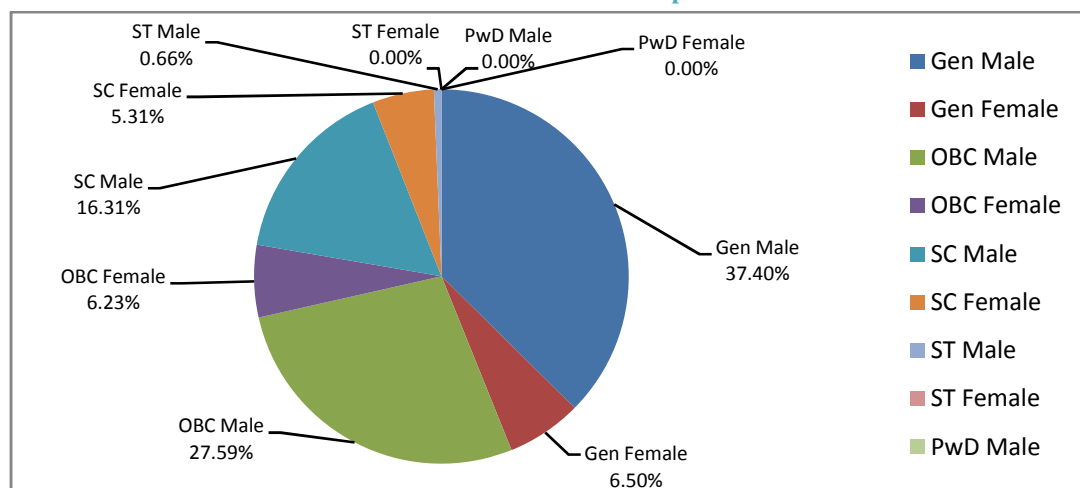

Gender wise distribution of Students

Awards/Honours/Fellowship received:

S.No.	Name of Faculty Member/ Student who received award	Name of the award	Organization conferring award
1.	Dr. Prakash Kumar Singh	Best paper award	MNNIT Allahabad & IGS Allahabad Chapter
2.	Dr. Priyamvada Singh	Award of Excellence	University of Allahabad

Funding received during the period (amount/purpose/agency) to the Department

S. No.	Agency	Purpose	Amount
1.	Laboratory Grant	Consumable & laboratory	Rs. 1.75 Lakh

Proposed Courses

S. No.	Name of Programme	Nature	Duration	Proposed or In process	Intake of Students	Remarks
1.	M.Sc. Tech. (Exploration Geophysics)	P.G. Degree	3 years (6 Semester)	Proposed	15	Need of the Time
2.	P.G. Diploma (Disaster management)	P.G. Diploma	1 Year (2 Semester)	Proposed		15

Outreach Activities:

S. N.	Name of Faculty Member/Student/ Researcher	Title of the paper presented	Title of Conference/ Seminar etc	Duration of the conference/ assignment	Organized by
1.	Dr. Priyamvada Singh	Attenuation of coda waves in Northeast Himalayas, India	Emerging trends in physical sciences (CONIAPS XXII)	April 13-16, 2018	Faculty of Science, Dr. Ram Manohar Lohia Avadh University, Faizabad
		An attempt to predict the disaster in making: a case study of Himalayan tectono-climate precursor	National Conference on Earth System Science with special reference to Himalaya: Advancement and Challenges	May 16-18, 2018	Wadia Institute of Himalayan Geology, Dehradun
		Portraying the 3-D geometry of a landslide and stability status using the geophysical and geotechnical approach: A Case Study from Jammu Lesser Himalaya	National Workshop on Landslides	May 23-25, 2018	Department of Geology L.S.M. Government Post Graduate College Pithoragarh, Uttarakhand
		Attended refresher course	Structural Geology, Tectonics, Thermo-dynamics and Metamorphic Petrology	July 1-14, 2018	IIT (ISM), Dhanbad, Jharkhand
		Attended Orientation Programme	120 th Orientation Programme	July 25 th to August 21 st , 2019	UGC, HRDC Allahabad
		Participated as special invitee	GEO India 2018, The 4th South Asian Geosciences Conference	September 6-8, 2018	Association of Petroleum Geologists India (APG)
2.	Mr. Vishwesh Kumar Pathak	Participant	GEO India 2018, The 4th South Asian Geosciences Conference	September 6-8, 2018	Association of Petroleum Geologists India (APG)
3.	Dr. Priyamvada Singh	Fuzzy criteria based recognition of groundwater prospective zones using GIS and Remote Sensing	New materials and application	October 13, 2018	Material research society of India- Allahabad chapter
4.	Professor Jayanta K. Pati	Giant quartz veins from Bundelkhand craton and other parts of the world: A comparative analysis.	Konferens Tapak Warisan Negeri Selangor Kearah Pengiktirafan Dunia 2018, Shah Alam, Malaysia	November 11-17, 2018	Department of National Heritage, Govt. of Malaysia, Kuala Lumpur

S. N.	Name of Faculty Member/Student/ Researcher	Title of the paper presented	Title of Conference/ Seminar etc	Duration of the conference/ assignment	Organized by
5.	Dr.Ravindra Pratap Singh	Participant	2 nd Induction Programme	November 12th to Dec 8th, 2018	Center of Excellence in Science and Mathematical Education and IISER Pune
6.	Dr. Priyamvada Singh	Attenuation of coda waves in the Northeast Himalayas, India	Advances in physical sciences to achieve sustainable development goals(CONIAPS XXIII).	November 16 – 18, 2018	Nepal Academy of Science and Technology (NASTA), Nepal
7.	Singh, A.K., Tripathi, J.N., And Singh, K..K.,	Application Of Satellite Remote Sensing And Gis In Agriculture Under Changing Climate Conditions	Advances In Agrometeorology For Managing Climatic Risks Of Farmers” (INAGMET-2019)	11-13 February 2019	Association of Agrometeorologists, IMD, IARI, and JNU, New Delhi
8.	Awasthi, N., Tripathi, J.N., Singh, K.K., Ghosh,K., .	Demonstration of the significance of statistical techniques and R software in analyzing the impact of weather events on Crop Yield,	International Symposium on Advances in Agrometeorology for Managing Climatic Risks of Farmers, at JNU, New Delhi,	11-13 February 2019.	Association of Agrometeorologists, IMD, IARI, and JNU, New Delhi
9.	Soni, A.K., Tripathi, J.N., Singh, P., Singh, K.K.,	Real-time monitoring, forecast and study the impact of climate variability on chill unit accumulation in Himachal Pradesh,	International Symposium on Advances in Agrometeorology for Managing Climatic Risks of Farmers, at JNU, New Delhi,	11-13 February 2019.	Association of Agrometeorologists, IMD, IARI, and JNU, New Delhi
10.	Soni, A.K., Tripathi, J.N., Singh, K. K., Singh, P., Ghosh, K., Durai, V. R.,	Real-Time Estimation And Forecast Of Reference Evapotranspiration Using Satellite-Based Observation And Medium-Range Weather Forecast Model,	Earth Observations For Agricultural Monitoring Presentation At Isprs-Geoglam-Isprs	February 18-20, 2019	ISPRS Working Group III/10,
11.	Vishwesh Kumar Pathak	Participant in the workshop	National workshop on Isotopes in Earth, Ocean and Atmospheric Science	February 18-20, 2019	IUAC and CSIR-NIO Goa
12.	Akhtar, S., Tripathi, J.N. And Ul Hasan M. S.,	Spatial And Statistical Analysis Of Toxic Metals In Noida Sector Of Uttar Pradesh, India	International Conference On Climate Change Impacts, Vulnerabilities, And Adaptation: Emphasis On India And Neighbourhood (CCIVA 2019)	February 26th to March 2nd, 2019	CORAL, IIT Kharagpur
13.	Singh, P.K., Kainthola, A., Singh, T.N., Tripathi, J.N.,	Rock Slope Monitoring Through Terrestrial LiDAR.	Proceedings of the Indian conference on Geotechnical and Environmental Engineering (ICGGE-2019), Paper 83, in (ISBN: 978-93-80634-47-0).	March 01-02, 2019	MNNIT Allahabad and Indian Geotechnical Society Allahabad Chapter, Prayagraj
14.	Dr. Priyamvada Singh	Attenuation of Coda waves for seismic hazards analysis.	Geotechnical and Geo Environmental Engineering	March 01-02, 2019	Department of civil engineering MNNIT Allahabad, Prayagraj
15.	Ms.Rahma Rafat	Attended TEQIP-III Sponsored One Week Short Term Course	New trends in wastewater treatment and its reuse	March 12-16, 2019	Department of chemical engineering MNNIT Allahabad, Prayagraj
16.	Dr.Prakash Kumar Singh	Participated in conference	National Conference on Role of Remote Sensing and GIS in Natural Hazard Assessment for Sustainable Development: Present Scenario and Future Perspective	March 15th, 2018	Department of Geology, University of Lucknow
17.	Dr.Ravindra Pratap Singh	Erosional patterns and morphometric analysis to infer the stability of the Jammu Lesser Himalayan slopes	National Conference on Role of Remote Sensing and GIS in Natural Hazard Assessment for Sustainable Development: Present Scenario and Future Perspective	March 15th, 2018	Department of Geology, University of Lucknow
18.	Professor Jayanta K. Pati	Shock features and the confirmation of terrestrial impact structures.	National Seminar of Northwest Indian Shield, Mohanlal Sukhadia University, Udaipur, Rajasthan	(March 15-16, 2019)	Mohanlal Sukhadia University, Udaipur, Rajasthan

Any other information (about the department/Center)

- **Geological Field Excursion for Students of Graduation**
The budding geologist get field exposure 23-26 November 2018 in the Central Indian Region of Chopan, Sonbhadra. The B.Sc. students experienced geological structures in the sedimentary rocks under the guidance of Dr.C.K.Singh and Dr.P.K.Singh.
- **Geological Field Excursion for Students of Post-graduation:**

The field excursion has been accomplished during January 7-17 2019 in the Kumaun Region of Uttarakhand Lesser Himalayas. A team of 23 M.Sc. students accompanied by 02 faculty members of the department (Dr. Prakash Kumar Singh and Dr. Ravindra Pratap Singh) had firsthand experience of geological structures and tectonics along Himalayan Frontal Thrust, Almora Thrust Belt and Munsiyari Thrust which reflects the dynamic nature of the Himalayas.



Students performing structural analysis in phyllites at Telgudwa, Chopan.



Students identifying the mode of failure with detailed engineering geological mapping at Munsiyari, Uttarakhand

- **Publication of Departmental Magazine**

The students published a magazine named **ROCK-TALK** and release the same in February 2019. The magazine is a collection to express their aptitude and views for the society and scientific world.

- **Teacher-Student-Alumni Interaction Session:** The interactive session was held on the occasion of Basant Panchami (February 10th 2019) at the Department. The alumni shared their experiences with the students and motivated them to work for recent and challenging problems in the field of geology.
- Three students (Mr. Anil Kumar Sahu, Mr. Digvijay Singh and Mr. Rahul Verma) from the M.Sc. Applied Geology 2018-19 batch have qualified GATE-2019.
- Mr. Rahul Verma student of M.Sc. Applied Geology 2018-19 batch has qualified CSIR-NET Dec-2018.

DEPARTMENT OF ELECTRONICS AND COMMUNICATION
J.K. INSTITUTE OF APPLIED PHYSICS & TECHNOLOGY, UNIVERSITY OF ALLAHABAD

Introduction:

Soon after the independence, the first Prime Minister of India, Pt. Jawahar Lal Nehru realized the need of a pioneer institute in the field of Applied Physics and related subjects. On his initiative an agreement was made between University of Allahabad and J.K. trust, Kanpur on November 22, 1947, to establish the J.K. Institute of Applied Physics and Technology in the premise of Faculty of Science, University of Allahabad. J. K. Charitable trust contributed for the construction of the complete building of the institute.

The foundation stone was laid by late Pt. Jawahar Lal Nehru, on April 14, 1949. Pt. Nehru also inaugurated the first academic session of the institute on April 4, 1956. Initially a 3 year post-graduate degree course named as M.Sc. (Technology) was started in the department. Later in 1970, on the advice of AICTE, the course was converted to a post B.Sc. – three year degree course (B.Tech. in Electronics and Communication) and a new course in M.Tech. (Electronics Engineering) was introduced. Undergraduate course (B.Sc.) in computer science was started in 1982. The Post graduate course in Computer Science (Software) was started in the year 1986. The Defence Research and Development Organization (DRDO) had selected the institute as a center to generate man power in computer science (Software). In 2008, a 3-years B.Tech. (Electronics and Communication) course was replaced by 4-years B.Tech. (Electronics and Communication Engineering) degree course and a new branch in engineering with B.Tech. (Computer Science and Engineering) and M.Tech. (Computer science and Engineering) was introduced. Department has started a new 3-years postgraduate degree course MCA from academic session 2018-19. The institute has a very good placement record and the Alumni of University are spread throughout the world and are occupying key positions in their field.

Thrust Areas:

- **Electronics and Communication:** Optical Fiber Communication, Microstrip Antenna, Embedded Systems, VLSI technology, Microwave and Antenna, Milli-meter Waves, Fiber Optic Communication, Soft Materials and Condensed Matter Physics etc.
- **Computer Science and Engineering:** Image Processing and Computer Vision, Natural Language Processing and Sentiment Analysis, Parallel and Distributed Computing and Cloud Computing, Cyber Security and Internet of Things, Optimization and Multimedia, Cryptography and Big Data Mining, WSN, MANET, IoT, IIoT.

Programmes of Study:

S. No.	Programme of Study	Duration	No. of Seats	Specialization(s)
1.	Ph.D.	5 years (includes course work)	Variable	Electronics and Communication, Computer Science and Engineering
2	M.Tech. (ECE)	02 years	15	Electronics Engineering
3	M.Tech. (CSE)	02 years	15	Computer Technology
4.	M.Sc. (Comp. Sc.)	02 years	30	Computer Science
5.	B.Tech. (ECE)	04 years	45	Electronics Engineering
6.	B.Tech. (CSE)	04 years	45	Computer Science and Engineering
7.	B.Sc. (Comp. Sc.)	03 years	90	Computer Science
8.	MCA	03 years	30	Computer Applications

Faculty members and their Area of Research:

S.N.	Name of Faculty	Designation	Area of Specialization
1	Dr. Ashish Khare	Associate Professor	Image and Video Processing, Computer Vision
2	Dr. C.K. Dwivedi	Professor	Embedded System
3.	Dr. J.A. Ansari	Professor (HOD)	Microwave Technology and Microstrip Antenna Design
4.	Dr. Mahendra Tiwari	Assistant Professor	Operating System
5.	Dr. N.K. Shukla	Professor	Fiber Optic Communication
6.	Dr. Nar Singh	Professor	Optical & Digital Communication

S.N.	Name of Faculty	Designation	Area of Specialization
7.	Dr. Pooja	Assistant Professor	Evolutionary Algorithm
8.	Dr. R.K. Srivastava	Professor	Photo-electrets, Mobile Communication
9.	Dr. R.R. Tewari	Professor	Robotics
10.	Dr. R.S. Yadav	Professor	Microwave Devices
11.	Dr. Rajeev Sigh	Professor	Polymer Electrets Micro Electronics
12.	Dr. Rajesh Kumar	Assistant Professor	Computer Vision
13.	Dr. Richa Mishra	Assistant Professor	Image Processing
14.	Dr. Shiv Prakash	Assistant Professor	Cloud Computing, Machine Learning
15.	Dr. Sudhakar Singh	Assistant Professor	Big Data Mining
16.	Dr. Sudhanshu Kumar Jha	Assistant Professor	Parallel Computing, WSN, MANET, IoT
17.	Dr. T.J. Siddiqui	Associate Professor	Natural Language Processing and Information Retrieval
18.	Er. P.N. Gupta	Associate Professor	Power Electronics
19.	Er. Rajeev Srivastava	Associate Professor	Micro Processor
20.	Mr. Pravin Kumar	Assistant Professor	Sentiment Analysis
21.	Mr. Vinod Kumar	Assistant Professor	Cryptography & Security
22.	Ms. Vandna Rathore	Assistant Professor	Image Processing and Cryptography

Support Staff:

S. No.	Name	Gender	Category	Designation	Work assigned
1.	Mr. Krishna Kumar Dwivedi	M	Ge	Jr. Office Assistant	Office Work
2.	Mr. Pramod Pathak	M	Gen	Electronic Engineer	Digital Electronics & Microprocessor Lab.
3.	Mr. Saurabh Kumar	M	Gen	Drawing & Survey Instructor	Engineering Drawing
4.	Mr. Piyush Kr. Mishra	M	Gen	Workshop Superintendent	Workshop
5.	Mr. Vidhu Kant Mishra	M	Gen	Technical Assistant	Computer Lab.
6.	Mr. PrayagDutt Bhatt	M	Gen	Technical Assistant	Communication Lab.
7.	Mr. Nalin Kumar Tiwari	M	Gen	Technical Assistant	Basic Electronics
8.	Mr. Manoj Kumar Srivastava	M	Gen	Technical Assistant	Computer Lab.
9.	Mr. Ravi Kumar	M	Gen	Technical Assistant	Fiber Optics Lab.
10.	Mr. Rajesh Kumar Saxena	M	Gen	Technical Assistant	B.Sc. Computer Sc. Lab.
11.	Mr. Akhilesh Kumar Tiwari	M	Gen	Store Keeper	Store
12.	Mr. Virendra Kumar	M	OBC	Jr. Mechanic	Workshop
13.	Mr. Vinay Kumar	M	OBC	Carpenter	Workshop
14.	Mr. ShyamBabu	M	SC	Lab. Attendent	Communication Lab.
15.	Mr. GovindBallabh	M	Gen	Lab. Attendent	Office
16.	Mr. Suresh Kumar	M	SC	Lab. Attendent	Library
17.	Mr. Bhuwadeshwar	M	OBC	Lab. Attendent	Office
18.	Mr. Ashok Kumar	M	SC	Lab. Attendent	Computer Lab.
19.	Mr. Manoj Kumar	M	SC	Poen	Basic Electronics Lab.
20.	Mr. Shiv Kumar	M	OBC	Lab. Attendent	Store
21.	Mr. Ram Manohar	M	SC	Poen	Computer Lab.
22.	Mr. Kharak Singh	M	Gen	Lab. Attendent	M.Sc. Lab.
23.	Mr. Rajendra Singh	M	Gen	Lab. Attendent	B.Sc. Computer Sc. Lab.
24.	Mr. Gyanwati Pal	M	OBC	Lab. Attendent	Electrical Lab.
25.	Mr. Sanjay Kumar	M	SC	Lab. Attendent	Fiber Optics Lab.
26.	Mr. Vinod Kumar	M	SC	SafaiKarmchari	Office
27.	Mr. Shailendra Kumar	M	SC	Lab. Attendent	B.Sc. Computer Sc. Lab.
28.	Smt. Poonam Pandey	F	Gen	Lab. Attendent	Fiber Optics Lab.

Details of Students, Programme wise and Reservation wise (2018-2019):

Course	Gen			OBC			SC			ST			PwD			TOTAL		
	Male	Female	Total	Male	Female	Total	Male	Female	Total	Male	Female	Total	Male	Female	Total	Male	Female	Total
Ph.D.	8	6	14	0	1	1	0	0	0	0	0	0	0	0	0	8	7	15
PG	22	12	29	19	7	26	5	0	5	0	0	0	0	0	0	46	19	65
UG	25	2	27	27	2	29	14	0	14	1	0	1	0	0	0	67	4	71
Total	55	20	70	46	10	56	19	0	19	1	0	1	0	0	121	30	151	

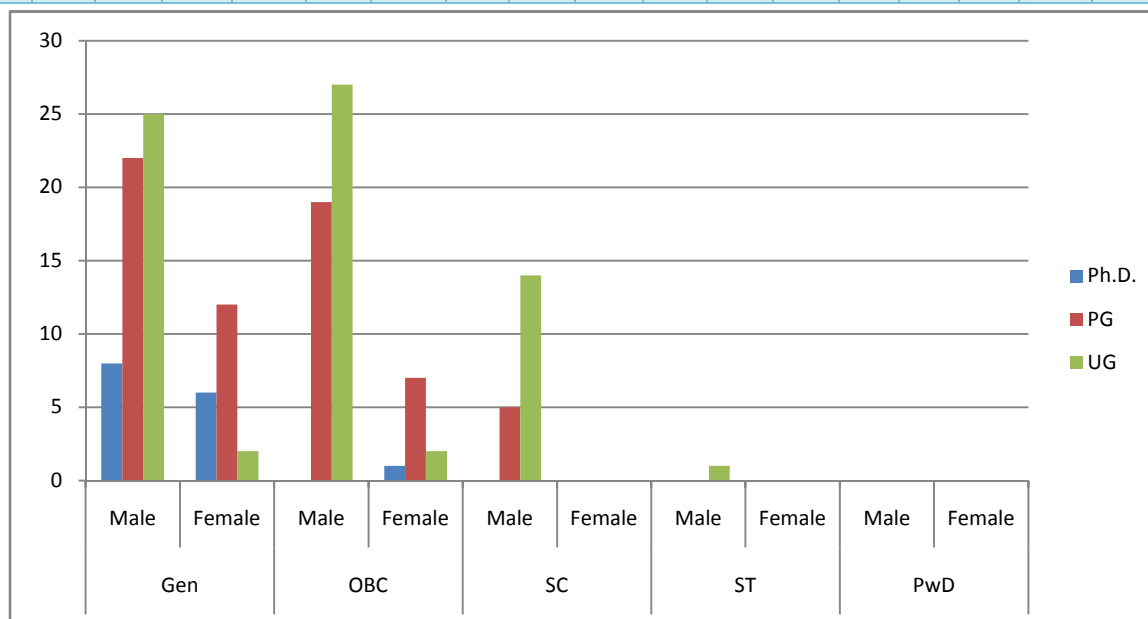

Student Enrollment for the Department

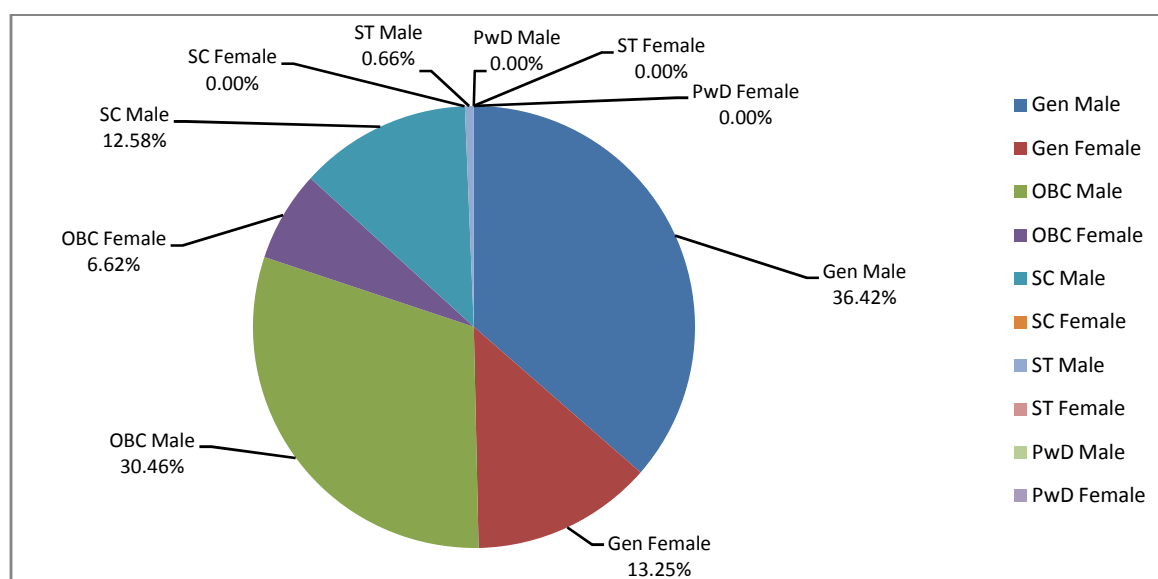

Gender wise distribution of Students

Seminars/Workshops/Conferences conducted by the Department/Centre:

S. No.	Name of the Seminar/workshop/conference	National / International	Duration and dates	Funding/sponsor Agenc(y/ies)	No. of Participants	No. of Papers presented
2.	International Conference on Emerging Trends in Communication, Computing and Electronics (IC3E-2018)	International	(03 days) 13-15 April, 2018	DST, Govt. of India CSIR, Govt. of India DRDO, Govt. of India	210	54

Training/orientation/refresher courses/special lectures conducted by the Department/Centre:

S. No.	Name of the course	Duration and dates	Funding/sponsor	Speakers
1.	One Day Workshop on Best Practice in Scientific Publishing	01 day (20/12/2018)	University of Allahabad	1. Dr. Bhavik Sawhney, Associate Editor, Nature, Springer 2. Dr. Tanveer J. Siddiqui, University of Allahabad 3. Prof. Rajeev Singh, University of Allahabad 4. Dr. Munish Kumar, University of Allahabad 5. Prof. C. K. Dwivedi, University of Allahabad
2.	One Day Workshop on Recent Trends in Artificial Intelligence and Deep Learning	01 day (25/02/2019)	University of Allahabad	1. Prof. S. A. M. Rizvi, Jamia Millia Islamia University 2. Prof. Rahul Kala, IIIT-Allahabad 3. Prof. Satish Kr. Singh, IIIT-Allahabad

Future Projections

INDUCTION OF NEW FACULTY MEMBERS

Remarkably after 17 years, 11 new faculty members were joined the department. Due to shortage of faculty, department was facing a lot of difficulties in handling the theory and lab. Specially in computer science and engineering discipline. On 5th November, 2019, an induction program was organized to welcome the new faculty members and various students admitted during academic session 2018-19. Prof. R. L. Hangloo, Vice Chancellor, University of Allahabad welcomed all new faculty members and also inaugurated the renovated departmental auditorium Prof. S. N. Ghosh Auditorium.

INDUSTRY – INTERACTION PROGRAMME:

A strong interaction between an institutions and industry is the need of the present market scenario. This will have great bearing on the course curriculum, exposure of industrial atmosphere to students and subsequent placement of young graduating mind in industries across the globe. With the advent of globalization and opening up of Indian economy to outside world, competitions among industries have become stiff. To solve their problems they look up now to Institutions. Similarly, there is an urgent need to prepare students for jobs in multinational companies, by exposing them to newer technologies and scientific methodologies. These objectives can only be achieved well by bridging the gap between industry and the academic institute. In this connection, Dept. of Electronics and Communication in association with M/S. Letz Dream4U Consultants Pvt. Ltd., Nehru Place, New Delhi organized an industry interaction programme on 26th February, 2019 in the Prof. S. N. Ghosh Auditorium of department, where students were benefited by knowing various process and procedure of the company, how they can enhance their skills to cope with the industry demand, benefits of doing summer internship, attending workshop, participation in various co-curricular activities.

Placements:

Department has separate training and placement cell, which is working hard for better future of students/faculty and staff. Regular interaction is being made with company and students. The table below shows the training and placement data for the academic year 2018-19:

All B.Tech. (CSE and ECE) final year interested and registered students for placement are placed.

Beside this, our students always cracking the All India level competitive examination for his/her better future. Following table illustrate the achievements by students during academic session 2018-19:

List of students qualified in GATE – 2019

S.No.	Name of Students	AIR Rank	S.No.	Name of Students	AIR Rank
1.	Shantam Srivastava	04	10.	Abhishek Kumar	1296
2.	Mohit Agarwal	75	11.	Arti Singh	1572
3.	Anant Jain	192	12.	Pranay Raj Anand	1644
4.	Anurag Chaudhary	295	13.	Amardeep Gupta	1754
5.	DishantKelkar	352	14.	Sana Anwar	1909
6.	Sumit Kumar	519	15.	Sachin Srivastava	2111
7.	Varun Kumar Singh	598	16.	Gauri Jain	2394
8.	TeegalaSarika	805	17.	UtkarshRastogi	2625
9.	Shivam Singh	1160			

Other Examination

GRE	Utkarsh Singh	score 331/340
TOEFL	Utkarsh Singh	score 112/120
CAT	MridulVerma	99.81 percentile
	Akanksha Chaudhary	93 percentile
	LkkavaramAmruth	92.28 percentile
NMAT	Akanksha Chaudhary	93 percentile
University of Nebraska at Omaha		BhawiniTripathi
McGill University, Canada		Shubhankar Mishra

Outreach activities:

S.N.	Name of Faculty Member/Student/ Researcher	Title of the paper presented	Title of Conference/Seminar etc.	Duration of the conference/ assignment	Organized by
1.	Dr. Ashish Khare		Workshop for development of Tactile kits	11th-15th February, 2019	NCERT, New Delhi
2.	Dr. Ashish Khare	Invited talk	One Week National workshop on Image Processing Computer Vision & Applications	05th-09th March, 2019	Rajkiya Engineering College, Ambedkar Nagar
3.	Dr. Rajesh Kumar	Invited talk	One Week National workshop on Image Processing Computer Vision & Applications	05th-09th March, 2019	Rajkiya Engineering College, Ambedkar Nagar
4.	Dr. Sudhanshu Kumar Jha	IoT Security and Privacy	Leveraging IT for Rising India	6th – 7 th October, 2018	SMS, Varanasi

TECHNO CUP 2K19 (T-20 cricket tournament)

The department organized most prestigious T-20 cricket tournament (Techno Cup) between March, 14-17,2019. Here nine teams took part including JK Alumni Team. It was inaugurated by Prof. R.L. Hangloo, Vice Chancellor, University of Allahabad. At this moment Prof. N.K. Shukla (Registrar AU), Prof. J.A. Ansari other faculty members were also present. Prof. Ansari heartily welcomed Vice Chancellor by his speech that stated his memoirs of Techno Cup from its founding day to this day with the presence of our chief guest which was inspirational. Prof. R. L.Hangloo appreciated our efforts to conduct a cricket tournament to such a grand level and guided us as to how sports are so essential amidst academics and research.



DEPARTMENT OF HOME SCIENCE

Introduction:

The department of Home Science was established in 1945, in pre independent India, with a two year undergraduate course with the objective to educate women. The department currently has 4 academic programmes - 1 Undergraduate course - B.Sc. Home Science (1945), 2 Postgraduate courses - M. Sc. Textile and Apparel Designing (2009), M. Sc. Food and Nutrition (2019), Ph.D. Programme - In all applied fields of Home Science (2011). Prof. S. Srivastava is currently the Head of Department. The department has 8 permanent faculties comprising of 1 Professor, 1 Associate Professor and 6 Assistant Professors. The department has 10 research scholars, doing research in innovative fields of apparel, dyeing, printing methods, weaving, finishing and fortified product development on foods and clinical investigation of food material using animal model. The department is actively engaged in community development programmes too. The Department comprises of: 1 library, 1 staff room, 2 faculty rooms, 1 seminar room, 3 class rooms, 4 well equipped laboratories which cater to 16 practical's of undergraduate and post graduate course, 1 laboratory for research scholars, Office, Head's room, 4 rest rooms (2 for the students), 1 sitting area for faculty and student interaction.

Thrust Areas:

Home science is a multidisciplinary subject that involves an interdisciplinary approach in synthesizing knowledge which focuses on following thrust areas:

- **Clothing And Textiles:** Dyeing, Printing, textile testing, computer aided designing, garment designing, drafting and garment construction.
- **Food And Nutrition:** Important nutrients, nutritional biochemistry, community nutrition, public health nutrition, health and hygiene, therapeutic diets and food science & food analysis, nutritional counseling.
- **Human Development:** Child development theories, study of life span and psychological counselling.
- **Extension Education:** Teaching and communication, various community programs, community work, folk songs, puppetry, street plays.
- **Family Resource Management:** Interior decoration, management of human resources, flower arrangement, pottery making.

Programme of Study:

S.No.	Programme of Study	Duration	No. of Seats	Specialization(s)
1.	Ph.D.	5 years (including course work)	28	Clothing and Textiles, Food and Nutrition, Extension Education
2.	M.Sc. (Textile and Apparel Designing)	2 years	15	Textile and Apparel Designing
3.	M.Sc. (Food and Nutrition)	2 years	25	Food and Nutrition
4.	B.Sc. (Home Science)	3 years	50	Home Science

Faculty members and their Area of Research:

S.No.	Name of Faculty	Designation	Area of Specialization
1.	Dr. Ena Gupta	Assistant Professor	Food and Nutrition, Diet Therapy, Community Nutrition and Nutritional Biochemistry
2.	Dr. Farida Ahmed	Assistant Professor	Communication and Media Research, Communication Plan Development, Monitoring and Evaluation Research and Gender Studies.
3.	Dr. Neetu Mishra	Associate Professor	Nutritional Biochemistry, Community Nutrition, Antioxidants and Diabetes
4.	Dr. Priya Keshari	Assistant Professor	Food and Nutrition, Public Health and Community Nutrition
5.	Dr. Priyanka Kesarwani	Assistant Professor	Textile Fibres, Textile Designing, CAD and Clothing Construction
6.	Dr. Sangita Srivastava	Professor & Head	Natural Dyes, Aromatic Finishes and Functional Clothing

S.No.	Name of Faculty	Designation	Area of Specialization
7.	Ms. Monisha Singh	Assistant Professor	Textile Fibres, Textile Designing, CAD and Apparel Construction
8.	Ms. Ritu K Sureka	Assistant Professor	Mentally Challenged Children, Domestic Violence and Dalit Women

Support Staff:

S.No.	Name	Gender	Category	Designation
1.	Mrs. Neeta Srivastava	Female	General	Lab Assistant
2.	Mrs. Kiran Devi	Female	OBC	Office Assistant
3.	Mrs. Archana	Female	SC	MTS
4.	Mrs. Savita Ojha	Female	General	MTS
5.	Amarnath	Male	OBC	Lab Attendant
6.	Maharanideen	Male	OBC	Block Servant
7.	Pradeep Singh	Male	General	Parichar

Details of Students, Programme wise and Reservation wise (2018-2019):

Course	Gen			OBC			SC			ST			PwD			Total			
	Male	Female	Total	Male	Female	Total	Male	Female	Total	Male	Female	Total	Male	Female	Total	Male	Female	Total	
Ph.D.	-	7	7	-	2	2	-	-	-	-	-	-	-	-	-	-	-	09	09
PG	-	16	16	-	08	08	-	04	04	-	-	-	-	-	-	-	-	28	28
UG	-	22	22	-	34	34	-	23	23	-	01	01	-	-	-	-	-	80	80
Total	-	45	45	-	44	44	-	27	27	-	01	01	-	-	-	-	-	117	117

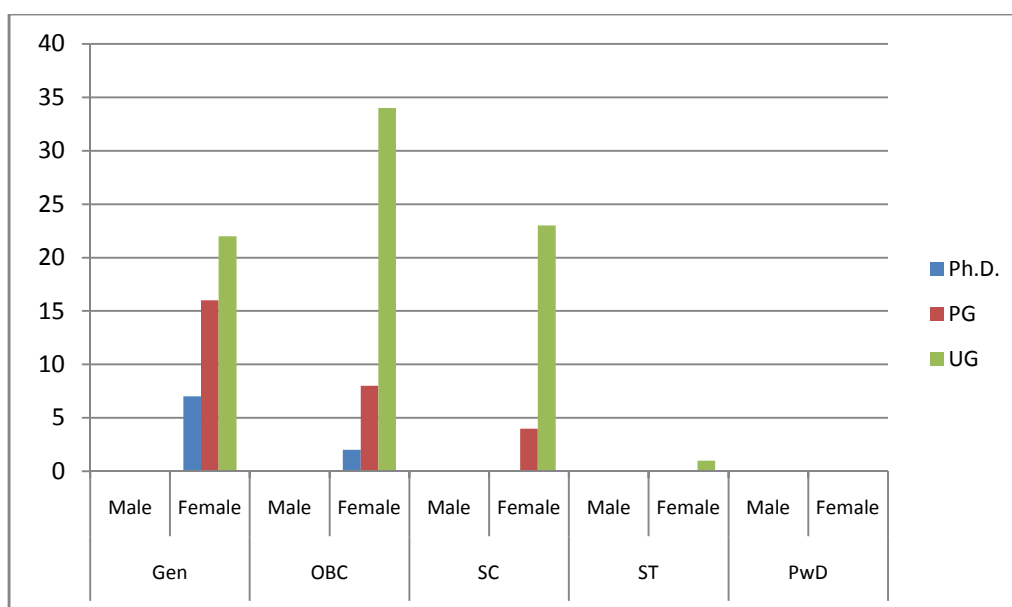

Student Enrollment for the Department

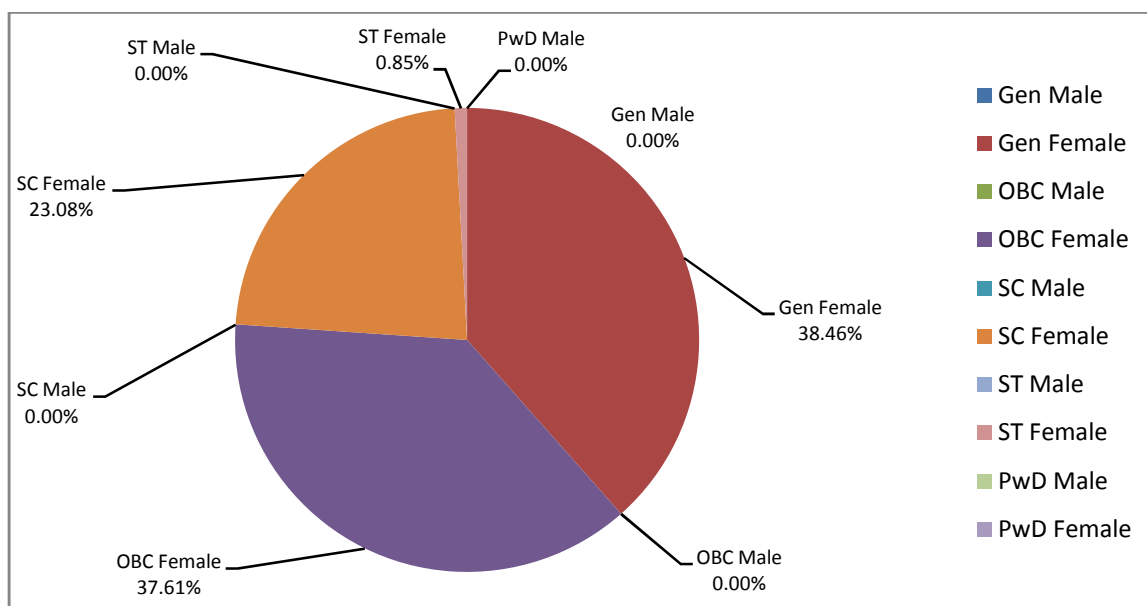

Gender wise distribution of Students

Seminars/Workshops/Conferences conducted by the Department/Centre

S. No.	Name of Seminar/ Workshop/ Conference	National/ International	Duration and dates	Funding/sponsor Agency(y/ies)	No. of Participants
1.	Workshop on Culinary Skills	National	January 5-6, 2019	Department of Home Science, University of Allahabad in collaboration with Institute of Hotel Management, Lucknow, U.P.	150
2.	Workshop on Swachhata Action Plan	National	January 3-4, 2019	Department of Home Science, University of Allahabad in collaboration with Institute of Hotel Management, Lucknow, U.P.	150

Training/Orientation/Refresher courses/Special lectures conducted by the Department:

S.No.	Name of the course/ Title of Lecture	Funding/sponsor	Duration and dates	Speakers
1.	Aspects of essential oils and Project formulations	Department of Home Science University of Allahabad	August 9, 2018	Dr. R.K. Srivastava CSIR-CIMAP, Lucknow
2.	Mental Diseases	Department of Home Science University of Allahabad	August 9, 2018	Dr. Anurag Verma Consultant Psychiatrist, Moti Lal Nehru, Medical College, Allahabad
3.	Dietary Management of Diabetes in Asian population.	Department of Home Science	February 6, 2019	Dr. Shaija Mathur (R.D) University of Rutgers, New Jersey, USA
4.	Exhibition of Garments	Department of Home Science University of Allahabad	15 th Dec,2018	NA

S.No.	Name of the course/ Title of Lecture	Funding/sponsor	Duration and dates	Speakers
5.	Two Street Plays On Swach Bharat Mission And Skill India, Performed By Students Of B.Sc. (Final Year) on the annual day function at Maheshvari Prasad Inter college	Department of Home Science University of Allahabad	24 th Nov, 2018	NA

Awards/Honours/Fellowship received:

S.No.	Name of Faculty Member/ Student who received award	Name of Award	Organization conferring award
1	Shivani Srivastava	Best Poster Presentation Award	CSIR-Central Institute of Medicinal And Aromatic Plants-Lucknow
2.	Dr. Priya Keshari	Best overall Presentation award	Institute of Academic Researcher (IAR Conferences), Srilanka with the supportive collaboration with the RCSI & UCD Malaysia Campus, Malaysia

Proposed Courses:

S.No.	Name of Programme	Nature	Duration	Proposed or In process	Intake of students
1.	M.Sc. in Food and Nutrition	Degree	2 Years	In process	20

Proposed projects/SAP Grants etc.:

S. No.	Type of Project/ grant	Title/Name	Duration	Proposed amount in lakh	Proposed or in process	Remarks
1.	DST-NASI	An Initiative For Increasing Awareness and Empowerment in Tribal Women of Rewa, M.P., with Special Concern to Health, Hygiene and Sanitation	2 years	6 lakhs	Already approved by DST-NASI	Sanctioned

Outreach activities:

S. No.	Name of Faculty Member/Student/ Researcher	Title of paper presented	Title of conference/ Seminar/ Workshop etc	Duration	Organised by
1.	Prof. Sangita Srivastava	NA	Rural women learning <i>agarbati</i> making	23 rd May 2018	CSIR-Central Institute of Medicinal And Aromatic Plants-Lucknow
2.	Prof. Sangita Srivastava	NA	Delivered lecture for Refresher course on the topic "Human Rights"	20 th Nov 2018	Faculty of Law and Human Resource Centre, UoA
1.	Shivani Srivastava	An essential oil derived mosquito repellent renewable finish for fabrics (Poster presentation)	National conference on Mints-Prospects, Challenges and Threats	February 15, 2019	CSIR-Central Institute of Medicinal And Aromatic Plants-Lucknow
2.	Tooba Fatma	Imprints of British Raj on Indian Clothing (Oral presentation)	National Seminar on Sustainable Fashion – An Emerging Chapter Towards a Greener World	February 24-26, 2019	Amity School of Fashion Technology, Lucknow Campus
3.	Prof. Sangita Srivastava	NA	Promoting Healthy Diets Through Local Food System (National Workshop)	February 20-21, 2019	New Delhi
4.	Dr. Neetu Mishra	NA	-do-	-do-	-do-

S. No.	Name of Faculty Member/Student/ Researcher	Title of paper presented	Title of conference/ Seminar/ Workshop etc	Duration	Organised by
5.	Dr. Ena Gupta	Nutraceutical and Therapeutic Properties of <i>Aegle marmelos</i> (L.)	International Conference on Advances in Agricultural, Biological and Applied Sciences for Sustainable Future (ABAS - 2018)	October 20 - 22, 2018	Swami Vivekanand Subharti University, Meerut, U.P.
6.	Dr. Farida Ahmad	'Communication in Rural India: A Policy Perspective'	XLII Indian Social Science Congress on 'Human Future in Digital Era'	December 27 - 31, 2018	KIIT University, Bhubaneswar, Odisha.
7.	Dr. Priya Keshari	Waist circumference as a measure of high risk for non-communicable diseases in urban geriatrics of Varanasi and their predictors	5 th National conference on non-communicable diseases and societal health: A Home Scientist Approach	October 5 - 6, 2018	Department of Home Science, Agrasen PG College, Varanasi
8.	Dr. Priyanka Kesarwani	<i>Hilicteres isora</i> : A plant fibre for textiles and technical applications	Seminar on sustainability of agriculture in changing scenario.	April 21 - 22, 2018	Department of Botany, University of Allahabad
9.	Prof. Sangita Srivastava	Interactive Session	Two Days State Level Workshop for Interaction and Accreditation of Resource Persons and Training on Women and Child Promotion Issues	December 6, 2018	State Resource Center for Woman and Child (SRCWC), Lucknow
10.	Dr. Neetu Mishra	-do-	-do-	-do-	-do-
11.	Dr. Farida Ahmad	-do-	-do-	-do-	-do-
12.	Dr. Ena Gupta	-do-	-do-	-do-	-do-
13.	Dr. Priya Keshari	-do-	-do-	-do-	-do-
14.	Dr. Priyanka Kesarwani	-do-	-do-	-do-	-do-
15.	Ms. Ritu Sureka	-do-	-do-	-do-	-do-
16.	Ms. Monisha Singh	-do-	-do-	-do-	-do-
17.	Dr. Neetu Mishra	NA	Short term training program on case study methods: Learning, Teaching and Writing	December 17-21, 2018	School of Management Studies, Motilal Nehru National Institute of Technology Allahabad, Prayagraj-211004
18.	Dr. Neetu Mishra	NA	National Cadet Corps, Namchi Sikkim Trek (Girls) 2018	November 12-18, 2018	National Cadet Corps, Darjeeling & Sikkim Group, Headquarter
19.	Dr. Priyanka Kesarwani	NA	Faculty Development Training Programme	April 9-22, 2018	Centre for Industrial and Management Consultants, Kanpur, U.P.
19.	Dr. Farida Ahmad	NA	Workshop on Swachhata Action Plan	January 3, 2019	Department of Home Science, UoA in collaboration with Institute of Hotel Management, Lucknow, U.P.
20.	Dr. Ena Gupta	-do-	-do-	-do-	-do-
21.	Dr. Priya Keshari	-do-	-do-	-do-	-do-
22.	Dr. Priyanka Kesarwani	-do-	-do-	-do-	-do-
23.	Ms. Ritu Sureka	-do-	-do-	-do-	-do-
24.	Ms. Monisha Singh	-do-	-do-	-do-	-do-
25.	Dr. Neetu Mishra	NA	Programme on 'Women in Science & Science for Women' Commemorating the International Women's Day	March 8-9, 2019	The National Academy of Sciences, India
26.	Dr. Priya Keshari	Interlinkages among socio-economic deprivation, food insecurity, under nutrition, self reported morbidities and physical dependence as well as psychosocial status in urban geriatric subjects: A community based study from central India	2nd International Conference on Public Health 2019 (Health Conf 2019) Sustainable Development Goals: Transforming Aspiration to Action For Human Health Kuala Lumpur, Malaysia	March 19 - 20, 2019	Institute of Academic Researcher (IAR Conferences), Sri Lanka with the supportive collaboration with the RCSI & UCD Malaysia Campus, Malaysia

Other Information:

Village Adoption:

S.No.	Village Adoption	Purpose	Dates
1.	Five villages (Alamchandra, Bajaha, shobhna, Basadi, Mohanapur) were adopted by Department of Home Science, University of Allahabad	To uplift the society by enhancing their nutritional status, educating the different parameters of hygiene and sanitation with special focus on skill development.	24 th Nov 2018



Workshop on Culinary Skills Organized by Department of Home Science, in collaboration with Institute of Hotel Management, Lucknow, U.P.



Distribution of old clothes in the village of Alamchand



Workshop for rural women on agarbati making in collaboration with CSIR-CIMAP, Lucknow



Street play on "hygiene and sanitation" in the village of Shobhna and Alamchad, by the students of B.Sc. H.Sc. III year, University of Allahabad



DEPARTMENT OF MATHEMATICS

Introduction:

Established in 1872 and situated presently in the Muir Central College Campus, the Department of Mathematics, University of Allahabad, is one amongst the oldest and prominent departments of mathematics of Indian Universities. The department offers courses for Undergraduate and Postgraduate degrees and has doctoral programs leading to the Ph.D. degree.

The department frequently organizes specific seminars, symposia and conferences aimed at offering significant and landmark results of value and potential for future work to our students and faculty which, in turn, raises the standard of teaching and education of the subject and prepares them to be capable to collaborate with various other centers of excellence in the country and abroad. The department emphasizes on rigorous teaching and learning exercise throughout the year to all the courses.

Thrust Areas:

- Algebra
- Mathematical Analysis
- Differential Geometry
- Fluid Mechanics and Mathematical Modelling
- Quantum Information and Computation

Programmes of Study:

S.No.	Programme of Study	Duration	No. of Seats	Specialization(s)
1.	Ph.D.	5 years (includes course work)		
2.	M.A./M.Sc.	2 years (4 semester course)	185	1. Non-linear Analysis 2. Dynamical Systems 3. Representation Theory of Finite Groups 4. Complex Manifolds 5. Advanced Fluid Mechanics 6. Wavelets
3.	B.A./B.Sc. (Mathematics Group)	3 years	B.Sc.= 647 B.A.= 70	

Faculty members and their Area of Research:

S. No.	Name	Designation	Area of Specialization
1.	Dr. A. K. Chaturvedi	Assistant Professor	Algebra (Theory of Rings and Modules)
2.	Dr. B. K. Sharma	Assistant Professor	Algebra
3.	Dr. G. C. S. Yadav	Assistant Professor	Wavelets
4.	Dr. M.A. Tiwari	Professor	Fluid Mechanics
5.	Dr. Mona Khare	Professor	Analysis
6.	Dr. Neeta Singh	Professor	Fixed Point Theory
7.	Dr. P. K. Singh	Professor	Fluid Mechanics
8.	Dr. R. P. Shukla	Professor	Algebra (Group Theory)
9.	Dr. Ramij Rahaman	Assistant Professor	Quantum Information and Quantum Computation
10.	Dr. S. S. Shukla	Professor	Differential Geometry
11.	Dr. Sapna Devi	Assistant Professor	Mathematical Modeling
12.	Dr. Satya Deo	Professor	Fluid Mechanics

Support Staff:

Sl.No.	Name	Gender	Category	Designation	Work assigned
1.	Sri Afaq Ahmad	M	OBC	J.O.A.	Official work
2.	Sri Shyam Sunder Rai	M	Gen	Library Assistant	Library work

Sl.No.	Name	Gender	Category	Designation	Work assigned
3.	Sri Ram Lakhan	M	OBC	Lab Attendant	Work of Lab Attendant
4.	Sri Omprakash	M	GEN	Peon	All type of work of class IV
5.	Sri Rajkumar	M	OBC	Book Attendant	Library work

Details of Students, Programme wise and Reservation wise (2018-2019):

Course	Gen			OBC			SC			ST			TOTAL		
	Male	Female	Total	Male	Female	Total	Male	Female	Total	Male	Female	Total	Male	Female	Total
Ph.D./ Ph.D.	2	-	2	2	1	3	1	-	1	1	-	1	06	01	07
PG	53	18	71	86	29	115	34	15	49	3	0	3	176	62	238
UG	351	60	411	480	103	583	174	32	206	32	6	38	1037	201	1238
Total	406	78	484	568	133	701	209	47	256	36	6	42	1219	264	1483

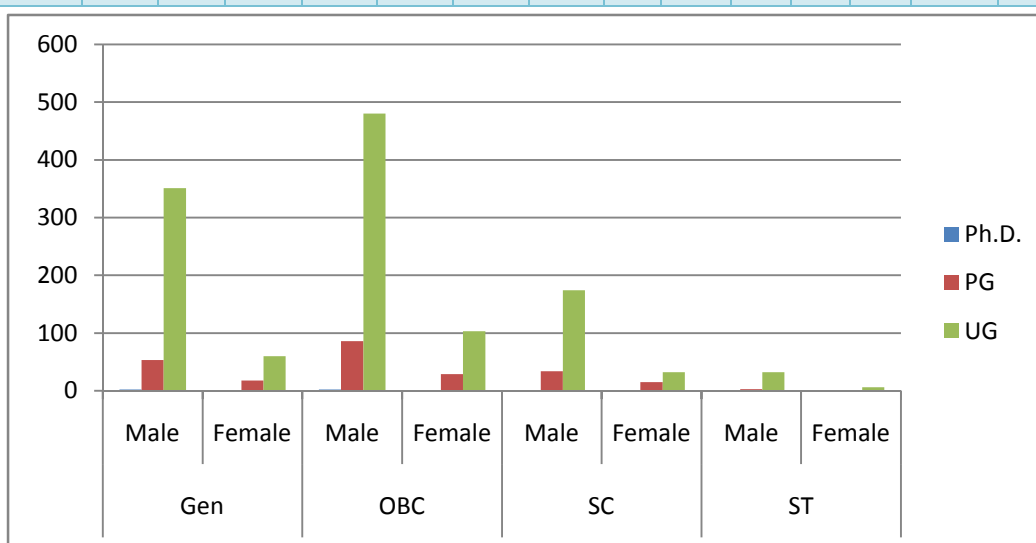

Student Enrollment for the Department

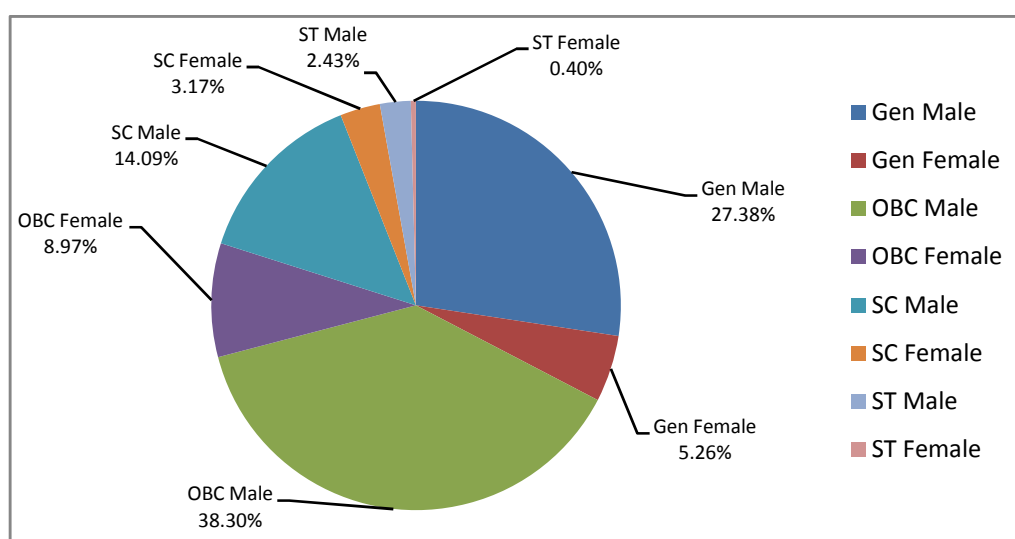

Gender wise distribution of Students

Training/orientation/refresher courses/special lectures conducted by the Department:

S. No.	Name of the course	Duration and dates	Speakers
1.	Title: "The Last Formula of Koszul" (Special Lecture)	November 28, 2018	Prof. Michel Nguiffo Boyom
2.	Title: "Prime Numbers" (Special Lecture)	December 22, 2018	Prof. N.Saradha Natarajan

Funding received during the period (amount/purpose/agency) to the Department

S.No.	Funding Agency	Purpose	Amount
1.	DST, New Delhi, India (FIST-2017)	Infrastructure (Equipment+Networking+Books)	Rs.30 Lakhs

Outreach activities:

S. N.	Name of Faculty Member/ Student /Researcher	Title of the invited lecture/ paper presented	Title of Conference/ Seminar etc	Duration of the conference/ assignment	Organized by
1.	Prof. P.K.Singh	Expert lecture	DST Sponsored Program "INSPIRE"	October 24, 2018	Savitri Devi Mahila Mahavidyalaya, Karachhana, Prayagraj.
2.	Prof. R. P. Shukla	Primitive Element Theorem and some Computations (Two invited lectures)	Two- day Workshop on Finite Fields and Galois Theory	December 22-23, 2018	National Academy of Sciences, India (NASI), Allahabad, India
3.	Prof. S. S. Shukla	Lightlike Submersions	National Conference on Differential Geometry and its Applications	August 03-05, 2018	Nehru Gram Bharati deemed University, Allahabad, India
		Some Classes of Submanifolds of Indefinite Sasakian Manifolds	National conference on Recent Trends in Mathematics (NCRTM)	November 10-11, 2018	Bharat Ganit Parisad and Dept. of Mathematics & Astronomy, University of Lucknow
4.	Prof. Satya Deo	Cell Models: A brief introduction and their applicability in solving fluid flow problems (Invited talk)	National conference on Recent Trends in Mathematics (NCRTM)	November 10-11, 2018	Bharat Ganit Parisad and Dept. of Mathematics & Astronomy, University of Lucknow, Lucknow
	Prof. Satya Deo	Cell Models: Brief introduction and hydro-dynamic permeability of a membrane (Invited talk)	National conference on Recent Trends in Mathematics with Applications (NCRTMA-19)	February 21-22, 2019	Faculty of Mathematical and Statistical Sciences, Shri Ramswaroop Memorial University, Lucknow
5.	Dr. B. K. Sharma	Attended	National Instructional Workshop on Cryptology (NIWC-2018)	June 06-10, 2018	Department of Mathematics, MNNIT, Prayagraj
6.	Dr. Sapna Devi	Invited Lecture: Logistic growth vs regrowth model with delay for the harvesting of vegetation biomass with its effects on CO ₂	National conference on Recent Trends in Mathematics with Applications (NCRTMA-19)	February 21-22, 2019	Faculty of Mathematical and Statistical Sciences, Shri Ramswaroop Memorial University, Lucknow
7.	Dr. Avanish Kumar Chaturvedi	Invited talk: Properties of Iso-Noetherian and Iso-Artinian Rings and Modules	International Conference on Algebra and Continuum Mechanics (ICACM-2018)	November 23-25, 2018	Department of Mathematics and Statistics, Himachal Pradesh University, Shimla,
8.	Surya Prakash (RS)	Paper Presentation: "On Iso-Noetherian Rings"	International Conference on Algebra, Analysis and Applications (ICAAA-2018)	August 09-11, 2018.	Department of Mathematics, Integral University, Lucknow
		Paper Presentation: "On Epi-Noetherian Rings and Modules"	International Conference on Algebra and Continuum Mechanics (ICACM-2018)	November 23-25, 2018.	Department of Mathematics and Statistics, Himachal Pradesh University, Shimla
		Attended	National Workshop on Groups and Symmetries	December 22-23, 2018	The National Academy of Sciences, Prayagraj, India
9.	Nivedita Gupta (RS)	A Mathematical Model to Control the Emission of Greenhouse Gases with the Help of Environmental Education and Tax	National Conference on Differential Geometry and its Applications	August 03-05, 2018	Nehru Gram Bharati deemed University, Allahabad, India
		An Approach to Impose Environmental Tax on the Mitigation of Greenhouse Gas Emission	International Conference on Algebra and Applied Analysis (ICAAA-2018)	August 09-11, 2018	Department of Mathematics, Integral University, Lucknow, India

S. N.	Name of Faculty Member/ Student /Researcher	Title of the invited lecture/ paper presented	Title of Conference/ Seminar etc	Duration of the conference/ assignment	Organized by
		Effects of Inclusion of Delay in the imposition of Environmental Tax on the Emission of Greenhouse Gases	International Conference on Mathematical Modeling and Computations (ICMMC-2018)	December 01-03, 2018	Department of Mathematics, South Asian University, New Delhi
		Attended	Two- day Workshop on Finite Fields and Galois Theory	December 22-23, 2018	National Academy of Sciences, India (NASI), Allahabad, India
10.	Surendra Kumar Mishra (RS)	Isotopic classes of Transversals in Dihedral group D_{2n} , n Odd	International Conference on Algebra and Applied Analysis (ICAAA-2018)	August 9-11, 2018	Department of Mathematics, Integral University, Lucknow
		Attended	Two- day workshop on Finite Fields and Galois theory	December 22-23, 2018	National Academy of Science India, Prayagraj
11.	Amita Dwivedi (RS)	Attended	Annual Foundation School I	May 07- June 02, 2018	IIT Kanpur, Kanpur, India
		Attended	Workshop on Integral Transformations Distributions and Wavelet Analysis	October 08-12, 2018	IIT(ISM) Dhanbad, Jharkhand, India
12.	Ajim Uddin Ansari (RS)	Participated	33rd Annual Conference of the Ramanujan Mathematical Society	June 01-03, 2018	Department of Mathematics, University of Delhi, Delhi, India
		Attended	National Instructional Workshop on Cryptology (NIWC-2018)	June 06-10, 2018	Department of Mathematics, MNNIT Allahabad, Prayagraj
		On Geometrical Aspects of Primary Decomposition of Ideals	National Conference on Differential Geometry and its Applications	August 03-05, 2018	Nehru Gram Bharati deemed University, Allahabad, India
		Different Types of G-Prim Ideals Associated to a Graded Module and Graded Primary Decomposition Over a Graded Prufer Domain	International Conference on Algebra and Applied Analysis (ICAAA-2018)	August 09-11, 2018	Department of Mathematics, Integral University, Lucknow, India
		Attended	Two- day Workshop on Finite Fields and Galois Theory	December 22-23, 2018	National Academy of Sciences, (NASI), Allahabad, India
13.	Rameshwar Prasad Mishra (RS)	A Mathematical Model to See the Effects of Increasing Environmental Temperature on Plant-Pollinator Interactions	Mathematical Modelling, Applied Analysis And Computation (ICMMAAC-18)	July 06-08, 2018	JECRC University, Vidhani, Sitapura Extension, Jaipur-303905, Rajasthan
14.	Rameshwar Prasad Mishra (RS)	Preservation of the Forestry Biomass and Control of Atmospheric CO ₂ Using Concept of Reserved Forestry Biomass	International Conference on Mathematical Modeling and Computations (ICMMC-2018)	December 01-03, 2018	Department of Mathematics, South Asian University, New Delhi
		Attended	Two- day Workshop on Finite Fields and Galois Theory	December 22-23, 2018	National Academy of Sciences, India (NASI), Allahabad,
15.	Arun Kumar (RS)	Attended	Annual Foundation School II	June 04-30, 2018	Assam University Silchar,
		Attended	Workshop on Integral Transformations Distributions and Wavelet Analysis	October 08-12, 2018	IIT(ISM) Dhanbad, Jharkhand,
		Attended	Two- day Workshop on Finite Fields and Galois Theory	December 22-23, 2018	National Academy of Sciences, (NASI), Allahabad,
16.	Pratibha Pandey (RS)	Participated	National Conference on Differential Geometry and its Applications	August 03-05, 2018	Nehru Gram Bharati deemed University, Allahabad,

S. N.	Name of Faculty Member/ Student /Researcher	Title of the invited lecture/ paper presented	Title of Conference/ Seminar etc	Duration of the conference/ assignment	Organized by
17.	Deepak Kumar Maurya (RS)	Attended	Short Term Course (GIAN Course) on Role of Fluid Flow and Mass Transport in Porous Media for Design of Chemical Reactors for Groundwater Remediation	August 20-24, 2018	IIT Guwahati, India
		Attended	NCM Workshop (ATM School) on Continuum Mechanics: Principles and Applications	November 19-24, 2018	Panjab University, Chandigarh
		Paper presentation: Stream Function Solution of the Brinkman Equation in the Parabolic Cylindrical Co-ordinates	International Conference on Mathematical Modeling and Computations (ICMMC-2018)	December 01-03, 2018	Department of Mathematics, South Asian University, New Delhi
		Generalized Stream Function Solution of the Brinkman Equation in the Cylindrical Polar Co-ordinates (3rd Prize in Paper Presentation)	National Conference on Recent Trends in Mathematics with Applications (NCRMTA-2019)	February 21-22, 2019	Shri Ramswaroop Memorial University, Lucknow
		Attended	National Workshop on Advances in Applications of Computational Fluid Dynamics	March 6 – 11, 2019	MNNIT Allahabad, Prayagraj
18.	Pankaj Kumar Maurya (RS)	Attended	Short Term Course (GIAN Course) on Role of Fluid Flow and Mass Transport in Porous Media for Design of Chemical Reactors for Groundwater Remediation	August 20-24, 2018	IIT Guwahati, India
		Attended	National Workshop on Advances in Applications of Computational Fluid Dynamics	March 6 – 11, 2019	MNNIT Allahabad, Prayagraj
19.	Shivam Omar (RS)	Participated	National Conference on Differential Geometry and its Applications	August 03-05, 2018	Nehru Gram Bharati deemed University, Allahabad,
		Attended	Two- day Workshop on Finite Fields and Galois Theory	December 22-23, 2018	National Academy of Sciences, (NASI), Allahabad
20.	Pawan Kumar (RS)	Participated	National Conference on Differential Geometry and its Applications	August 03-05, 2018	Nehru Gram Bharati deemed University
		Attended	Two- day Workshop on Finite Fields and Galois Theory	December 22-23, 2018	National Academy of Sciences, India (NASI), Allahabad, India
21.	Vipul Singh (RS)	Participated	National Conference on Differential Geometry and its Applications	August 03-05, 2018	Nehru Gram Bharati deemed University, Allahabad,
22.	Satish Kumar (RS)	Attended	National Workshop on Advances in Applications of Computational Fluid Dynamics	March 6 – 11, 2019	MNNIT Allahabad, Prayagraj

DEPARTMENT OF PHYSICS

Introduction:

The Department of Physics was established by Prof. Meghnad Saha, Fellow of the Royal Society, in 1923. Since then the department produced galaxy of eminent scientists, educationalist, industrialists and planners, ministers and administrators of national & international repute. The academic standard is well recognised by prestigious institutes and laboratories of national & international standard.

Thrust Areas:

1. Experimental Condensed Matter Physics
2. Nano Science and Nano Technology (Interdisciplinary)
3. Organic Electronics and Emerging Photovoltaics
4. Ion Beam in Materials Science
5. ESR/EPR Spectroscopy
6. Laser Induced Breakdown Spectroscopy and Photoacoustic Spectroscopy
7. Atomic and Molecular Spectroscopy, Imaging Spectroscopy
8. Theoretical Condensed Matter Physics
9. High Energy Physics
10. Plasma Physics
11. Physics of Shock Waves
12. Chaos and Fractal Analysis
13. Quantum Optics and Teleportation

Programmes of Study:

S.No.	Programme of Study	Duration	No. of Seats	Specialization(s)
1.	Ph.D.	5 years (includes course work)	14	Electronics, Condensed Matter Physics, Non Linear Optics, Spectroscopy, Nuclear Physics, X-rays, Shock waves, etc
2.	M.Sc.	2 year (4 semesters)	112	Electronics, Condensed Matter Physics, Non Linear Optics, Spectroscopy, Nuclear Physics, X-rays and Ion Beam
3.	B.Sc.	3 year	1025	Physics
4.	Diploma		25	Photography

Faculty members and their Area of Research:

S.N.	Name	Designation	Area of Specialization
1.	Dr. A K Rai	Professor & Head	Laser & Spectroscopy, LIBS, PAS, LIF
2.	Dr. Asheel Kumar	Associate Professor	Plasma Physics
3.	Dr. K N Uttam	Professor	Atomic and Molecular Spectroscopy, Applications of Spectroscopy in the field Bio Science
4.	Dr. Lokendra Kumar	Professor	Organic Electronics, Nano Science & Technology, Ion Beam in material Science, thin films
5.	Dr. P S Yadav	Professor	Electronic and Solid State Physics
6.	Dr. Pratima	Professor	Nano Science & Technology (Interdisciplinary)
7.	Dr. Raj Kumar Anand	Associate Professor	LIBS, PAS, LIF & SWs with reference to its Astrophysical and Geophysical applications
8.	Dr. V.K. Tiwari	Professor	High Energy Physics, Elementary Particle Physics

Support Staff:

S. No	Name	Gender	Categ.	Designation	Work Assigned
1.	Sri Gulab Singh	Male	GEN	Workshop training instructor	Workshop training class, all financial accounting works, Purchase
2.	Sri Uma Kant	Male	OBC	Office Assistant	Office handling

S. No	Name	Gender	Categ.	Designation	Work Assigned
3.	Sri Prabhat Kumar Mishra	Male	GEN	Mechanic	Electrical & Mechanical equipments maintenance
4.	Sri Kartik Chandra Parmanik	Male	OBC	Lab Assistant (GB)	Lab assistant work
5.	Sri Prabhu Nath Sharma	Male	OBC	Carpenter	Carpentry Work, helps in different labs
6.	Sri Ajay Singh	Male	GEN	Computer Operator	Supervising Computer Labs
7.	Sri Pankaj Kumar	Male	OBC	Library Assistant	Handling and supervising library
8.	Sri Arun Kumar	Male	SC	Dark Room Assistant	Dark Room Assistant,
9.	Sri Beni Prasad Mishra	Male	GEN	Junior Office Assistant	Assisting office
10.	Sri Jai Sarvesh Bharti	Male	SC	Technical Assistant	Repairing of scientific apparatus of labs
11.	Sri Akhilesh Adaval	Male	GEN	Technical Assistant	Assisting Physics Society all works
12.	Smt. Pinki Chatterji	F	GEN	Sr. Technical Assistant	Assist in CMPR Lab
13.	Sri Lalit Prakash Shukla	Male	GEN	Microwax Operator	Assist Research Work in CMPR Lab
14.	Sri Vigyan Prakash Mishra	Male	GEN	Office Assistant	Assists in office work

Class IV

1.	Sri Naresh Kumar	Male	SC	Sweeper	Cleaning of Department and Road
2.	Sri Hira Mani	Male	OBC	Book Attendant	Maintaining Library
3.	Sri Chotey Lal	Male	OBC	Lab Attendant	Cleaning Lab, Minor repairing
4.	Sri Ghanshyam	Male	OBC	Lab Attendant	Cleaning Lab, Minor repairing
5.	Sri Anand Kumar Gaur	Male	OBC	Lab Attendant	Cleaning Lab, Minor repairing
6.	Sri Arvind Kumar Singh	Male	GEN	Lab Attendant	Cleaning Lab, Minor repairing
7.	Sri Kaushal Kishor Yadav	Male	OBC	Lab Attendant	Cleaning Lab, Minor repairing
8.	Smt. Kamla Devi	Female	SC	Sweeper	Cleaning of Department and road
9.	Sri Mahendra Bahadur Singh	Male	GEN	Lab Attendant	Cleaning Lab, Minor repairing
10.	Sri Om Prakash	Male	OBC	Lab Attendant	Cleaning Lab, Minor repairing
11.	Sri Ashok Kumar	Male	OBC	Lab Attendant	Cleaning Lab, Minor repairing
12.	Sri Rudal Prasad	Male	OBC	Lab Attendant	Cleaning Lab, Minor repairing
13.	Smt. Kiran	Female	OBC	Lab Attendant	Cleaning Lab
14.	Sri Ram Sajeevan	Male	OBC	Lab Attendant	Cleaning Lab, Minor repairing
15.	Sri Nokhe Lal	Male	OBC	Lab Attendant	Cleaning Lab, Minor repairing
16.	Sri Gulab Chandra	Male	OBC	Peon	Cleaning Lab, Minor repairing
17.	Sri Hem Chandra	Male	OBC	Lab Attendant	Cleaning Lab, Minor repairing
18.	Sri Ajit Kumar	Male	OBC	Lab Attendant	Cleaning Lab, Minor repairing
19.	Sri Sambhu Prasad Gaur	Male	OBC	Lab Attendant	Cleaning Lab, Minor repairing
20.	Sri Mukesh Kumar Kushwaha	Male	OBC	Lab Attendant	Cleaning Lab, Minor repairing

Details of Students, Programme wise and Reservation wise (2018-2019):

Course	Gen			OBC			SC			ST			PwD			TOTAL		
	Male	Female	Total	Male	Female	Total	Male	Female	Total	Male	Female	Total	Male	Female	Total	Male	Female	Total
Ph.D.	10	10	20	9	4	13	5	2	7	0	0	0	-	-	-	24	16	40
PG	23	6	29	44	10	54	11	6	17	5	0	5	1	0	1	84	22	106
UG	297	49	202	386	82	468	130	22	152	27	5	32	-	-	-	840	158	998
Total	330	65	251	439	96	535	146	30	176	32	5	37	1	0	1	948	196	1144

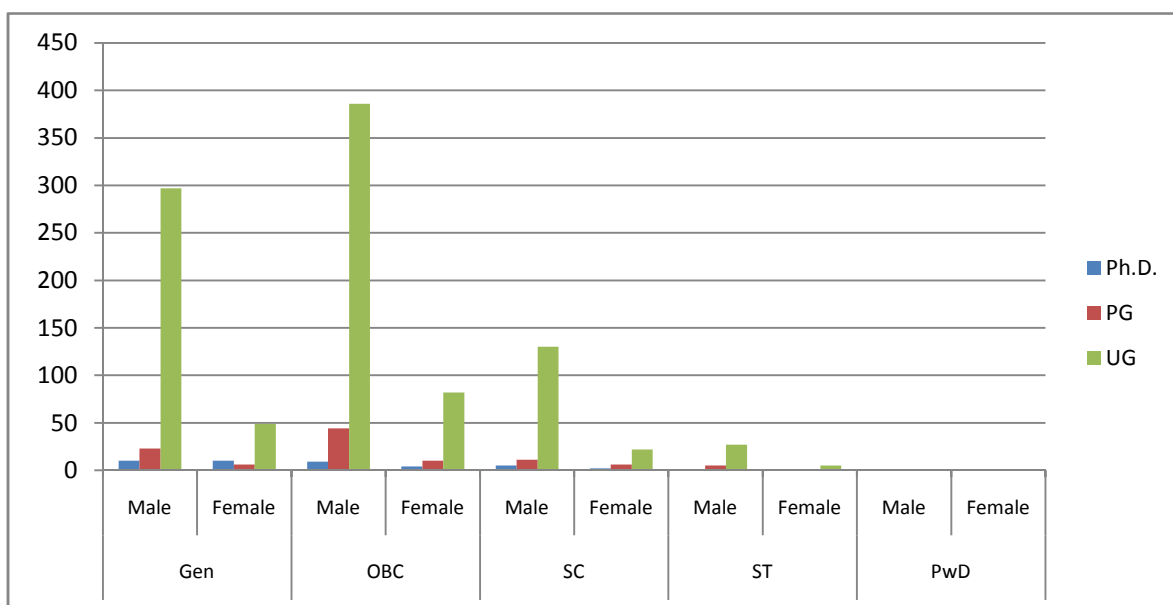

Student Enrollment for the Department

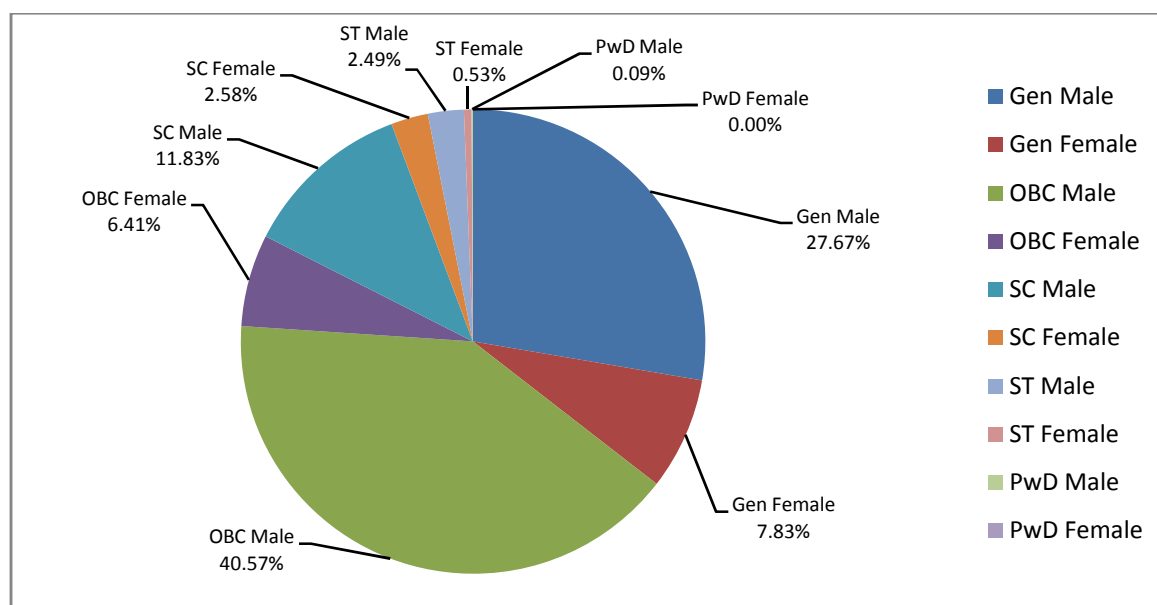

Gender wise distribution of Students

Training/orientation/refresher courses/special lectures conducted by the Department:

S. No.	Name of the course	Duration and dates	Funding/ sponsor	Speakers
1.	Refresher course in Physics	21 days 12/11/2018 – 02/12/2018	UGC sponsored	External experts of different specialization from other institute/ university/higher learning centre

Awards/Honours/Fellowship received:

S.No.	Name of Faculty Member/ Student who received award	Name of the award	Organization conferring award
1.	Prof. A.K. Rai	Member Executive Council (Governor Nominee)	Goa University, Goa

Funding received during the period (amount/purpose/agency) to the Department

S.No.	Agency	Purpose	Amount (in Rs.)
1.	Consumable of Laboratory grant	Consumable, spare parts and minor repairing	7.00 lakhs

Proposed Projects/SAP Grants etc.

S. No.	Type of Project/grant	Title/Name	Duration	Proposed amount	Proposed or In process	Remarks
1.	DST-FIST project	Theoretical and experimental Physics	5 years	10 crores	In process	Proposal will be submitted to DST in future

Other Projections:

1. New dimensions of the research addressing the societal problems will be taken up.
2. The modernization and development of the central research facilities in the department will be initiated.

Outreach activities:

S.N.	Name of Faculty Member/ Student/ Researcher	Title of the paper presented	Title of Conference/ Seminar etc	Duration of the conference/ assignment	Organized by
1	Prof. A.K. Rai	Application of Laser based technique for the study of Biomaterials	National Symposium on Applied Spectroscopy: Biology and Medical Science	February, 19 & 20, 2019	Udai Pratap College Varanasi
2	Prof. K.N. Uttam	Raman and its applications		February 27, 2019	NASI-Allahabad
3.	Prof. Lokendra Kumar	Evolution of Highly Efficient Solution Processed Perovskite Solar Cells and Challenges to the Commercialization	National Conference On Recent Advances in Experimental and Theoretical Physics	April 17-18 2018	Department of Physics & Astronomical Sciences Central University of Jammu
4	Prof. Lokendra Kumar	Insights into solution processed hybrid perovskite active layers and strategies towards improving stability and performance for perovskite photovoltaics	National Conference on Advanced Nanomaterials and their Applications	December 21-23, 2018	MNNIT-Allahabad, Prayagraj
5	Prof. Lokendra Kumar	Convener	One day National Seminar on New Materials & Applications (NSNMA-2018)	October 13, 2018	MRSI-Allahabad Chapter at Nehru Science Centre, Allahabad University
6	Prof. Lokendra Kumar	Senior Jury Member	7th National level Exhibition and project Competition (NLEPC) of INSPIRE Awards-MANAK	February 14-15, 2019	Jointly Organised by NIF-DST, India at IIT Delhi

DEPARTMENT OF STATISTICS

Introduction:

The Statistics unit came into existence in 1968 as a part of Department of Mathematics and Statistics. The unit really became functional with the appointment of three regular teachers of Statistics in 1974 under the esteemed leadership of outstanding statistician and researcher in the field of Bayesian Reliability Analysis, Professor Samir K. Bhattacharya. On August 21, 2000, the department was separated from mathematics with Dr. G.S. Pandey as the first Head of Department. Presently, Prof. S. Lalitha is the Head of the Department. The department also extends technical assistance to the researchers of other departments, such as Bioinformatics, Biotechnology, Botany, Economics, Education, Psychology, Medical Sciences, Zoology, etc.

Thrust Areas:

- Econometrics, Regression Analysis
- Nonparametric Inference and Outliers Statistic
- Reliability and Survival Analysis, Reliability modeling
- Bayesian Statistics
- Time Series analysis and Forecasting
- Data Mining, Network modeling
- Actuarial Statistics

Programmes of Study:

S. No.	Programme of Study	Duration	No. of Seats	Specialization(s)
1.	Ph.D.	5 years(includes course work)	01	Statistics
2.	M. A./M. Sc.	2 years	31	Statistics
3.	B. A./B. Sc.	3 years	71	Not Required

Faculty members and their Area of Research:

S. No.	Name of Faculty	Gender	Designation	Area of Specialization
1.	Dr. Anoop Chaturvedi	Male	Professor	Econometrics, Time Series analysis, Regression Analysis
2.	Dr. Pramendra Singh Pundir	Male	Assistant Professor	Reliability and Survival Analysis
3.	Dr. S. Lalitha	Female	Professor	Nonparametric Inference and Outliers in Statistical Data

Support Staff:

S. No.	Name	Gender	Category	Designation	Work assigned
1.	Sandeep Kumar Yadav	Male	OBC	Junior Office Assistant	Office work
2.	Badri Vishal Sharma	Male	GEN	Peon	
3.	Ramakant Mishra	Male	GEN	Peon	

Details of Students, Programme wise and Reservation wise (2018-2019):

Course	Gen			OBC			SC			ST			PwD			TOTAL		
	Male	Female	Total	Male	Female	Total	Male	Female	Total	Male	Female	Total	Male	Female	Total	Male	Female	Total
Ph.D.	1	3	4	2	0	2	0	0	0	0	0	0	0	0	0	3	3	6
PG	10	10	20	11	10	21	1	1	2	0	0	0	0	0	0	22	21	43
UG	39	13	52	47	6	53	19	3	22	3	1	4	0	0	0	108	23	131
Total	50	26	76	60	16	76	20	4	24	3	1	4	0	0	0	133	47	180

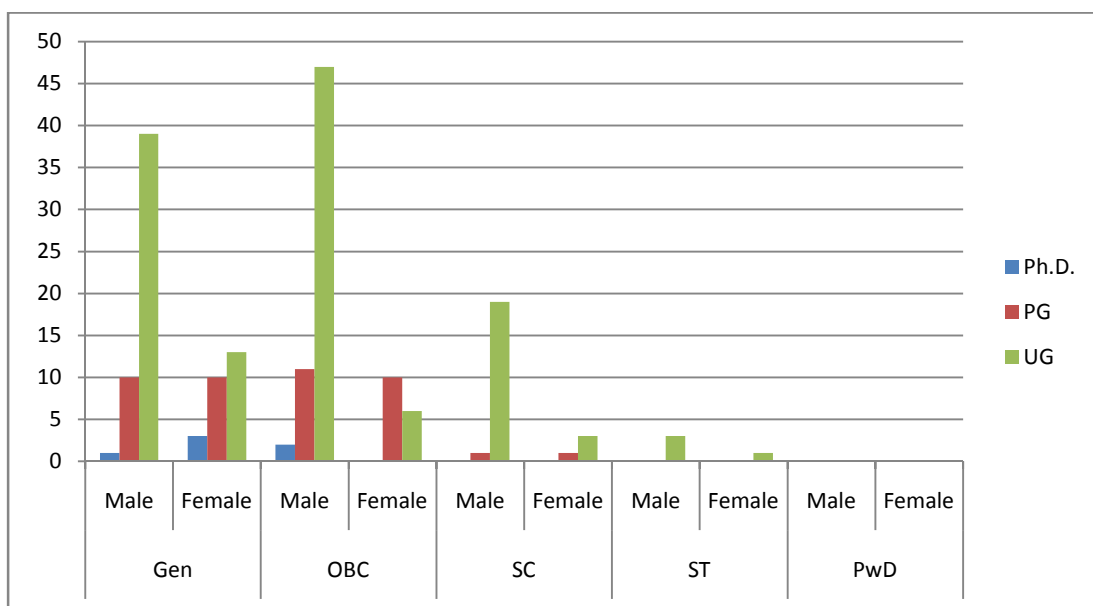

Student Enrollment for the Department

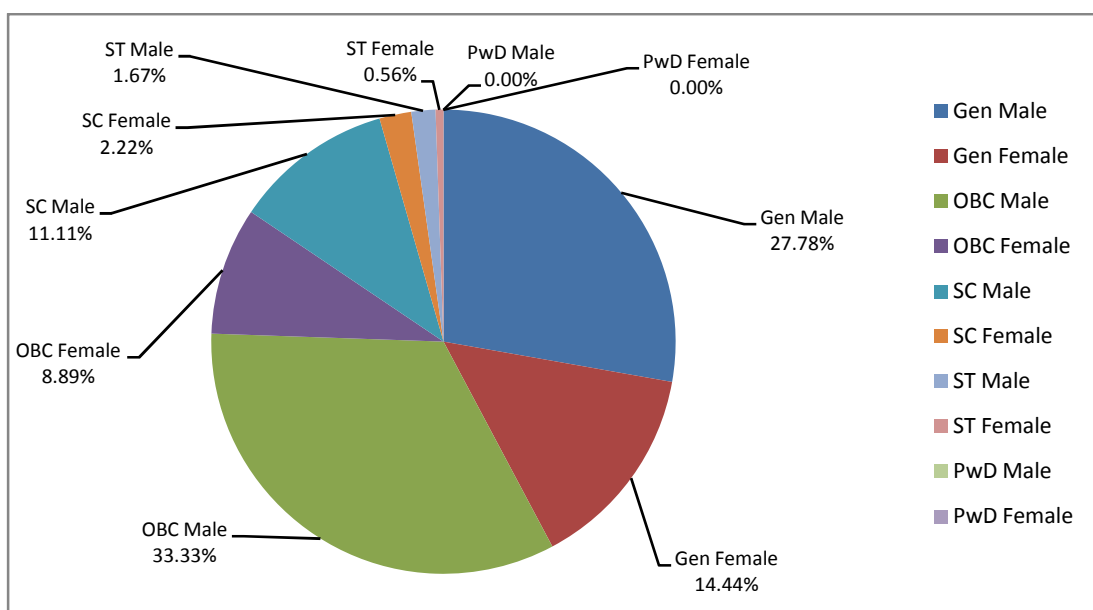

Gender wise distribution of Students

Other publications by the Department/Centre

S.No.	Title	Type	Author(s)	Publication	ISBN
1.	Reliability Estimation in Load-Sharing System Model with Application to Real Data	Research Paper	Pramendra Singh Pundir and Puneet Kumar Gupta	Annals of Data Science	2198-5812
2.	Stochastic outlook of two non-identical unit parallel system with priority in repair	„	Pramendra Singh Pundir, Rohit Patawa and Puneet Kumar Gupta	Cogent Mathematics & Statistics	2574-2558

S.No.	Title	Type	Author(s)	Publication	ISBN
3.	Analysis of Hybrid Censored Competing Risks Model with Bathtub-Shaped Failure Time	„	Pramendra Singh Pundir and Puneet Kumar Gupta	Journal of Statistics Applications & Probability Letters	2090-8458
4.	Modelling and Forecasting Age-Specific Mortality Rates in India	„	Pramendra Singh Pundir, Abhinav Singh, Gyan Prakash Singh and Anurag Verma	World Wide Journal of Multidisciplinary Research and Development	2454-6615
5.	Stress-Strength Reliability of Two-Parameter Bathtub-Shaped Lifetime Model Based on Hybrid Censored Samples	„	Pramendra Singh Pundir and Puneet Kumar Gupta	Journal of Statistics & Management Systems	2169-0014
6.	Robust linear static panel data models using ϵ -contamination	„	Badi H. Baltagia, Georges Bresson, Anoop Chaturvedi and Guy Lacroix	Journal of Econometrics	0304-4076
7.	Bayesian analysis of unit root testing for panel data time series model in the presence of time effec	„	Jitendra Kumar, UmmeAfifi and Anoop Chaturvedi	Pakistan Journal of Statistics	1012-9367

Outreach activities:

S.N.	Name of Faculty Member/Student/Researcher	Title of the paper presented	Title of Conference/Seminar etc	Duration of the conference/assignment	Organized by
1.	Mr. Abhinav Singh	Application of Bayesian Hierrarichal model in probabilistic population projection	4 th Asian population Association Conference, Shanghai, China.	11/07/2018-14/07/2018	Shanghai University , Shanghai, China.

DEPARTMENT OF ZOOLOGY

Introduction:

The Department of Zoology is one of the oldest Departments of University of Allahabad. The Department came into existence in the year 1906 with Prof. F.M. Howlett in the chair. He was succeeded by the world renowned entomologist, Prof. A.D. Imms. The Department not only flourished but reached the zenith of glory under the able stewardship of Prof. W.N.F. Woodland, Prof. D. R. Bhattacharya, Prof. M.D.L. Srivastava and Prof. U.S. Srivastava.

Apart from quality teaching the Department has been in the forefront in scientific research. The faculty members are actively involved in research, publishing high quality research papers in national and international journals with high impact factor like Springer, Elsevier, Wileys, Taylor & Francis and Cambridge journals. A lot of contribution has been made in the field of neurobiology as well as Fish and Fisheries under the supervision of Prof. Anita Gopesh. Entomology is another thrust area of research being pursued under the supervision of Prof. Krishna Kumar to explore the effect of hormones/juvenoids for insect pest management. Prof R. S. Pandey is associated with the research in Biochemistry. Prof Banalata Mohanty is actively engaged in the fields of neuroendocrinology and endocrine pharmacology. Prof. K. P. Singh has made important contributions in the field of Neurobiology specially on neuropsychopharmacology and neurobehaviour of rodents.

Thrust Areas:

- Entomology
- Neurobiology
- Fish and Fisheries
- Biochemistry
- Cell Biology

Programmes of Study:

S.No.	Programme of Study	Duration	No. of Seats	Specialization(s)
1.	Ph.D.	5 years (includes course work)		Entomology, Neurobiology, Neuroendocrinology, Fish and Fisheries, Biochemistry
2.	M. Sc.	Zoology (I-IV Sem CBCS)	62	Entomology, Fish & Fisheries, Cell Biology
3.	M.Sc. Ag.	Agricultural Zoology & Entomology (I-IV Sem CBCS)	15	--
4.	B. Sc.	3 years (annual pattern)	308	--

Faculty members and their Area of Research:

S.No.	Name of Faculty	Designation	Area of Specialization
1.	Dr. Anita Gopesh	Professor & Head	Fish & Fisheries
2.	Dr. Banalata Mohanty	Professor	Endocrinology
3.	Dr. K. P. Singh	Professor	Neurobiology
4.	Dr. Krishna Kumar	Professor	Entomology, Insect Endocrinology
5.	Dr. R.S.Pandey	Professor	Biochemistry

Support Staff:

S.No.	Name	Gender	Category	Designation	Work assigned
1.	Mr. Ajay Kumar Asthana	Male	GEN	Sr. Technical Assistant	M.Sc. labs (02)
2.	Mr. M.M. Bhatt	Male	GEN	Technical Assistant	B.Sc. Lab (01)
3.	Mr. Ramesh Chandra Ojha	Male	GEN	Jr. Office Assistant	Office
4.	Mr. Anand Kumar	Male	OBC	Carpenter	

Class- IV Employees

S.No.	Name	Gender	Category	Designation
1	Mr. Sheshbal Mishra	Male	GEN	Lab Attendant
2	Mr. Raj Kumar	Male	SC	Lab Attendant
3	Mr. Harish Chandra	Male	SC	Lab Attendant

S.No.	Name	Gender	Category	Designation
4	Mr. Pradeep Kumar	Male	SC	Lab Attendant
5	Mr. Dileep Kumar	Male	SC	Lab Attendant
6	Mr. Surender Singh Bisht	Male	GEN	Lab Attendant
7	Mr. Ashok Kumar	Male	OBC	Lab Attendant
8	Mr. Basant Lal	Male	OBC	Lab Attendant
9	Mr. Raju	Male	SC	Sweeper

Details of Students, Year wise and Reservation wise (2018-2019):

Course	Gen			OBC			SC			ST			PwD			TOTAL		
	Male	Female	Total	Male	Female	Total	Male	Female	Total	Male	Female	Total	Male	Female	Total	Male	Female	Total
Ph.D.	06	11	17	03	02	05	02	02	04	00	00	00	00	00	00	11	15	26
PG	29	20	49	28	28	56	16	10	26	02	07	09	00	01	01	75	65	140
UG	62	126	188	86	121	207	66	47	113	08	10	18	00	00	00	222	304	526
Total	97	157	254	117	151	268	84	59	143	10	17	27	00	01	01	308	384	692

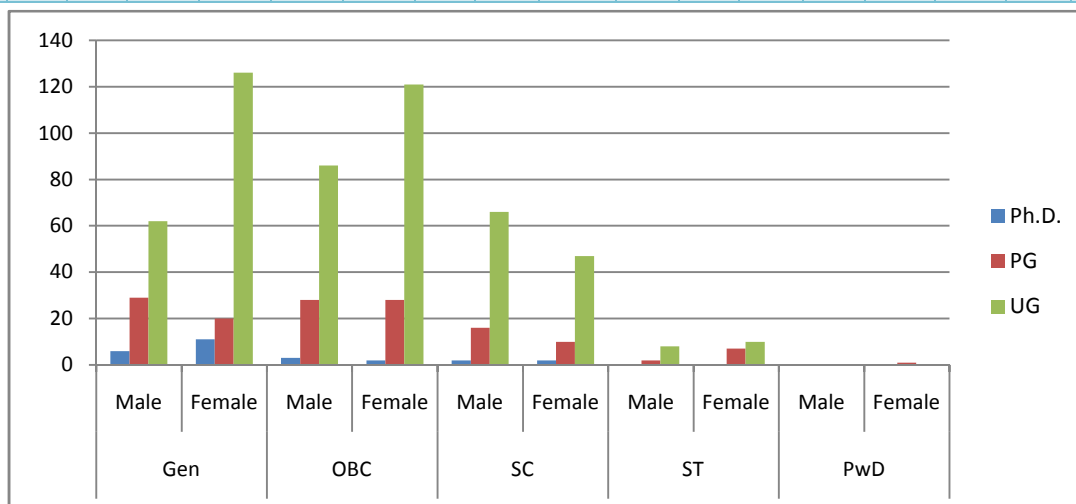

Student Enrollment for the Department

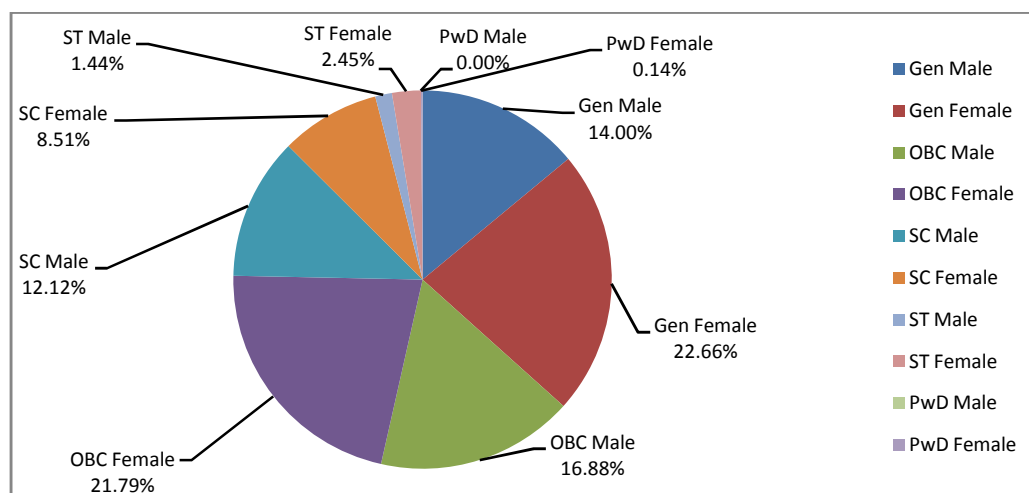

Gender wise distribution of Students

Awards/Honours/Fellowship received:

S. No.	Name of Faculty Member/ Student who received award	Name of the award	Organization conferring award
1.	Prof. K. Kumar	Fellowship of the Society- 2018	Royal Entomological Society of London
2.	Prof. Ravi S. Pandey	FBRS	Bioved Research Society
3.	Prof. K. P. Singh	Award of Excellence- 2018	University of Allahabad
4.	Prof. K. P. Singh	Distinguished Service Award-2019	Society of Biological Sciences and Rural Development

Funding received during the period (amount/purpose/agency) to the Department

S. No.	Agency	Purpose	Amount
1.	Allahabad University Zoology Lab grant 2018-19	Chemicals/consumables	Rs 4,00,000=00 (Rs four lakhs only)
2.	Allahabad University Agricultural Zoology & Entomology Lab grant 2018-19	Equipments/consumables for Ag.Zoology & Entomology	Rs 1.50 lakhs only

Outreach activities:

S.N	Name of Faculty Member/Student/ Researcher	Title of the paper presented	Title of Conference /Seminar etc	Duration of the conference/ assignment	Organized by
1.	A. Gopesh & Sonal Tripathi	Invited talk on Paraneuronal gill NE cells in fishes: Probable bio-indicators	13 th World Conference on Neurology and Neuromuscular Disorders	1-2 October, 2018	Frankfurt, Germany
2.	K. P. Singh, K. Gupta, M. K. Singh & N. Verma	Maternal exposure to novel atypical psychotropic drugs: Impact on fetal brain development, apoptotic neurodegeneration and psychopathological sequelae in young offspring	13 th World Conference on Neurology and Neuromuscular Disorders	1-2 October, 2018	Frankfurt, Germany
3.	Banalata Mohanty	Invited talk on "Exploring the gut brain axis in mice model of psychosis"	International Conference on Emerging trend in Research in Bioscience (ICERB)	28-30 Oct 2018	Bilaspur, India
4.	Banalata Mohanty	Invited talk	Humboldt Kolleg on Comparative Endocrinology & Physiology	7-9 Jan, 2019	RTM University Nagpur Maharashtra
5.	Kiran Gupta and K. P. Singh	Effect of prenatal exposure to pregabalin induced neuronal apoptosis in the developing rat brain and its long-lasting effects on young offspring.	National seminar on Future India: Science and Technology (NSFIST)	February 22-24, 2019	ISCA, Allahabad Chapter Allahabad
6.	Niharika Verma and K. P. Singh	Prenatal exposure to Eslicarbazepine acetate: Impact on maternal, reproductive and fetal toxicity.	National seminar on Future India: Science and Technology (NSFIST)	February 22-24, 2019	ISCA, Allahabad Chapter Allahabad
7.	Manoj Kr. Singh and K. P. Singh	Effect of prenatal exposure to iloperidone on maternal body weight gain and reproductive toxicity in albino rats	National seminar on Future India: Science and Technology (NSFIST)	February 22-24, 2019	ISCA, Allahabad Chapter Allahabad
8.	Niharika Verma and K.P. Singh	Impact of a novel anticonvulsant on developing fetal brain and associated neurobehavioural changes in offspring	International Conference on Advances in Zoological Research (ICAZR) & Workshop on Real-Time PCR	9 th -10 th March, 2019	Department of Zoology, A.M.U., Aligarh
9.	Ajeet Kr. Mishra, K. P. Singh & Anita Gopesh	Effects of acute toxicity of chlorpyrifos on cerebellum, pseudobranchial neurosecretory cells and locomotor behavior of air breathing catfish <i>Heteropneustes fossilis</i>	National conference in Recent advancement in neurophysiology and neuropharmacology	02-03 Nov, 2018	Indian academy of neurosciences (IAN) & GLA University, Mathura
10.	Ajeet Kr. Mishra, K. P. Singh & Anita Gopesh	Effect of sub-chronic toxicity of chlorpyrifos on brain and behaviour of an air-breathing catfish, <i>Heteropneustes fossilis</i>	88 th Annual session and Symposium of National Academy of Sciences, India	6-7 December, 2018	Mahatma Gandhi Gramodaya vishwavidyalaya, Chitrakoot

S.N	Name of Faculty Member/Student/ Researcher	Title of the paper presented	Title of Conference /Seminar etc	Duration of the conference/ assignment	Organized by
11.	Ajeet Kr. Mishra, K. P. Singh & Anita Gopesh	Effect of sub-chronic toxicity of chlorpyrifos on optic tectum, pseudobranchial neurosecretory system and locomotory performances of an air-breathing catfish, <i>H.fossilis</i>	National Seminar on Future India: Science and technology		Indian science congress association, local chapter Allahabad, Prayagraj
12.	Kirti Ojha	Neuronal plasticity in Parahippocampal area (APH) during non-breeding period of <i>Coracias benghalensis</i> (Linnaeus, 1758)	International Conference on Neuroscience and XXXVI Annual Meeting of Indian Academy of Neuroscience	October 29-31, 2018	Banaras Hindu University, Varanasi
13.	Kirti Ojha and K P Singh	Seasonal plasticity in spine density of multipolar neurons of Parahippocampal area of Indian roller, <i>Coracias benghalensis</i> " in)	National seminar on Future India: Science and Technology (NSFIST)	February 22-24, 2019	ISCA, Allahabad Chapter Allahabad
14.	Sonal Tripathi and Anita Gopesh	Paraneuronal pseudobranchial neurosecretory system in certain non-catfish teleosts	International conference on Neurosciences and XXXVI Annual meeting of Indian Academy of Neurosciences	29-31 October, 2018	Banaras Hindu University, Varanasi
10.	Nidhi and Anita Gopesh	Changing scenario of fish catch in the Ganga river at Allahabad: need of sustainable fishery	National Seminar on Sustainable development in India: Issues and Challenges	27-28 Nov, 2018	S.S. Khanna Girls Degree College, Allahabad
11.	Sonal Tripathi and Anita Gopesh	Paraneuronal pseudobranchial neurosecretory system in certain teleosts	88 th Annual session and symposium of National Academy of Sciences, India	6-7 December, 2018	M.G. Chitakoot Gramodaya Vishwavidyalaya, Chitrakoot, Satna, M.P
12.	Sonal Tripathi and Anita Gopesh	Paraneurons in the gill region of fishes: The Pseudobranchial neurosecretory System	National Symposium on Innovations in Agriculture, Environment and Technology for Inclusive Development	17-18, march, 2019	Allahabad
13.	Gaur, S.K. and Kumar, K.	Insect growth regulatory effects of a medicinal plant, <i>Withania somnifera</i> L. (Dunal), on two polyphagous pests, <i>Spodoptera litura</i> and <i>Pericallia ricini</i> .	National seminar on future India: science and technology	February 22-24, 2019	Indian Science Congress Association
14.	Gaur, S.K. and Kumar, K.	Evaluation of root extracts of <i>Withania somnifera</i> (Family: Solanaceae) for insect growth regulatory activity against <i>Chrysomya megacephala</i> (Diptera: Calliphoridae).	National seminar on sustainable development in India: issues and challenges	November 27-28, 2018	S S Khanna Girl's Degree College, Allahabad in collaboration with NASI Allahabad,
15.	Gaur, S.K. and Kumar, K.	Insect growth regulating effects of <i>Withania somnifera</i> on a polyphagous pest, <i>Pericallia ricini</i> (Lepidoptera: Arctiidae)	International symposium on recent trends in agriculture, biodiversity and social sustainability	Sep, 30 & Oct 01, 2018	Blue Planet Society, Allahabad, Botanical Survey of India, Allahabad
16.	Gaur, S.K. and Kumar, K.	Effect of a medicinal plant, <i>Withania somnifera</i> , on the metamorphosis of tobacco caterpillar, <i>Spodoptera litura</i> (Lepidoptera: Noctuidae).	International symposium on indiscriminate development: current scenario & socio-environmental challenges	March 18-19, 2018	Blue Planet Society, Allahabad, U.P., India, Botanical Survey of India, CRC, Allahabad
17.	Tiwari RK and Pandey RS	Acute toxicity Assessment for chlorpyrifos and cypermethrin in combination to a fresh water fish, <i>Heteropneustes fossilis</i> and its impact on AChE activity	106 th Indian Science Congress	2019	Lovely Professional University
18.	Singh S and Pandey RS	Studies on the impact of triazophos and deltamethrin on some biochemical parameters of earthworm, <i>Eudrilus eugeniae</i>	106 th Indian Science Congress	2019	Lovely Professional University
19.	Singh U and Pandey RS	Assessment of stress parameters as biomarker of water pollution in industrial effluent treated Indian major carp, <i>Labeo rohita</i> .	106 th Indian Science Congress	2019	Lovely Professional University

S.N	Name of Faculty Member/Student/ Researcher	Title of the paper presented	Title of Conference /Seminar etc	Duration of the conference/ assignment	Organized by
20.	Tiwari RK, Singh S and Pandey RS	Haematological and histopathological studies on cypermethrin exposed fresh water teleost, <i>Heteropneustes fossilis</i>	In National conference on Impact of environmental xenobiotics on human health and biodiversity organised	2018	Department of Zoology, Lucknow University
21.	Singh S, Tiwari RK and Pandey RS	Haematological and histopathological alterations in fresh water teleost, <i>Channa punctatus</i> exposed to deltamethrin.	National conference on Impact of environmental xenobiotics on human health and biodiversity	2018	Department of Zoology, Lucknow University
22.	Singh U and Pandey RS	Toxicological Assessment of Fertilizer Industry Effluent and its impact on hematological parameters and Acetylcholinestrace (AChE) Activity in a Fresh Water Teleost, <i>Labeo rohita</i> .	National conference on the impact of Environmental Xenobiotics on Human Health and Biodiversity	2018	Department of Zoology, Lucknow University

Other nformation

1. Prof. B. Mohanty acted as a resource person in Odisha Education Services I, Induction Programme for University/College Teacher, Berhampur University, Odisha, India.
2. Prof. B. Mohanty acted as a resource person in World Bank assisted Odisha Higher Education Programme for Educational Excellence: Refresher course for University/ College Teachers, 03-23 Dec, 2018.
3. Prof. Anita Gopesh, chaired the session on “Translationel Research in Improving Mental Health” at International conference on Neurosciences and XXXVI Annual meeting of Indian Academy of Neurosciences, BHU, Varanasi on 29-31 Oct , 2018.
4. Prof. Anita Gopesh, chaired the Biological Session at National seminar on Future India: Science and Technology (NSFIST), organised by Indian science congress association, local chapter Allahabad, Prayagraj on February 22-24, 2019.
5. Prof. K. P. Singh, chaired the Biological Session at National seminar on Future India: Science and Technology (NSFIST), organised by Indian science congress association, local chapter Allahabad, Prayagraj on February 22-24, 2019.
6. Mr. Ajeet Kr. Mishra awarded Certificate of Appreciation award in National conference in Recent advancement in neurophysiology and neuropharmacology from IAN organized by GLA University in oct.2018.
7. Mr. Ajeet Kr. Mishra awarded Best Oral presentation award in National Seminar on Future India: Science and Technology Indian Science Congress Association, local chapter Allahabad, Feb.2019.

INSTITUTE OF INTERDISCIPLINARY STUDIES

CENTRE OF BIOTECHNOLOGY

Introduction:

The Centre of Biotechnology at University of Allahabad came into existence in the year 1999 and it was inaugurated by Nobel laureate Prof Richard R Ernst. It offers Masters (4 semesters) and Ph.D. programme in Biotechnology. For Masters programme students are admitted through all India Combined Entrance Examination conducted by Jawaharlal Nehru University, New Delhi. For Ph.D. Programme University holds combined research entrance test (CRET) every year and provides scholarship to the successful candidates. At present centre has strength of 4 faculties

Highlights:

- Prof. M.P. Singh became Vice-President, AMI (Association of Microbiologist of India) local unit, Allahabad. The unit was inaugurated by General Secretary, AMI on 23rd April 2018 at SHUATS, Naini, Allahabad. (http://www.amiindia.info/ami_unit.php)
- CBT (Centre of Biotechnology) Organized Mushroom Production Training Programme for Farmers on 31st January 2019.
- CBT Organized DBT Sponsored Short term training program (STTP) for UG/PG Teachers on “Hands on Techniques used in Biotechnology” from 17 December 2018 -1st January 2019.
- Dr. Manish Arora, BHU delivered Lecture on “Design Based Innovation Opportunity for UG PG Students in the university system” on 11th January 2019.
- Prof. M.P. Singh awarded ‘Fellow’ AEB (Academy of Environmental Biology) on 3rd October 2018.
- DST SERB has sanctioned ITS (International Travel Grant) to Prof. M.P. Singh to session a Chair and give Invited Oral Talk in the International Conference "Smart Biomedical and Physiological Sensor Technology XVI" at Baltimore Convention Center, Maryland, USA during 14-18 April 2019
- Prof. D.R. Modi, BBAU, Lucknow delivered Lecture on “**Probiotics- An overview of beneficial effects on health and nutritional properties**” on 21st August 2018.
- Prof. M.P. Singh reviewed a Research Project for financial assistance on request of Czech Science Foundation, the mail funding agency of Czech Republic in July 2018.

Thrust Areas:

The Centre of Biotechnology has a vision to develop a "Centre for Excellence" to create a Biotech hub and Entrepreneur Park. Centre has identified the following nine research areas as priority areas:

- Cyanobacterial Biotechnology
- Microbial & Mushroom Biotechnology
- Nanobiotechnology
- Stem Cells biology

These areas have been identified keeping in mind the current and future burning issues that have direct bearing on the health, nutrition, environment and agriculture of the world in general and India in particular. Priority areas in individual sectors would be assessed from time to time to ensure optimal utilization of existing resources for biotechnology applications.

Programmes of Study:

S. No.	Programme of Study	Duration	No. of Seats	Specialization(s)
1.	Ph.D.	3- 5 years (includes course work)	08	As in thrust area
2.	M. A./M. Sc.	02 Years (04 Semester)	19	

Faculty members and their Area of Research:

S. No.	Name of Faculty	Gender	Designation	Area of Specialization
1.	Dr. Awadh Bihari Yadav	M	Assistant Professor	Nanobiotechnology, Infectious Diseases, siRNA/shRNA and targeted drug delivery
2.	Prof. Mohan Prasad Singh	M	Professor	Molecular Biology; Microbial & Mushroom Biotechnology
3.	Prof. Shanthi Sundaram	F	Professor	Algal & Plant Biotechnology, Immunology of Kala Azar
4.	Dr. Vinod Verma	M	Assistant Professor	Stem Cell Cancer Biology

Support Staff:

S. No.	Name	Gender	Category	Designation	Work assigned
1.	Ramesh Dwivedi	M	General	Junior Office assistant	Official work
2.	Nidhi Pandey	Female	General	MTS	Supporting office
3	Ram Niranjana	Male	General	Peon	Supporting office
4	Kamla Devi	Female	SC	Block Servant	Supporting office

Details of Students, Year wise and Reservation wise (2018-2019):

Course	Gen			OBC			SC			ST			PwD			TOTAL		
	Male	Female	Total	Male	Female	Total	Male	Female	Total	Male	Female	Total	Male	Female	Total	Male	Female	Total
Ph D.	-	-	-	-	01	01	-	-	-	-	-	-	-	-	-	0	01	01
PG	04	05	09	02	02	04	01	02	03	01	01	02	0	0	00	08	10	18
Total	04	05	09	02	03	05	01	02	03	01	01	02	0	0	00	08	11	19

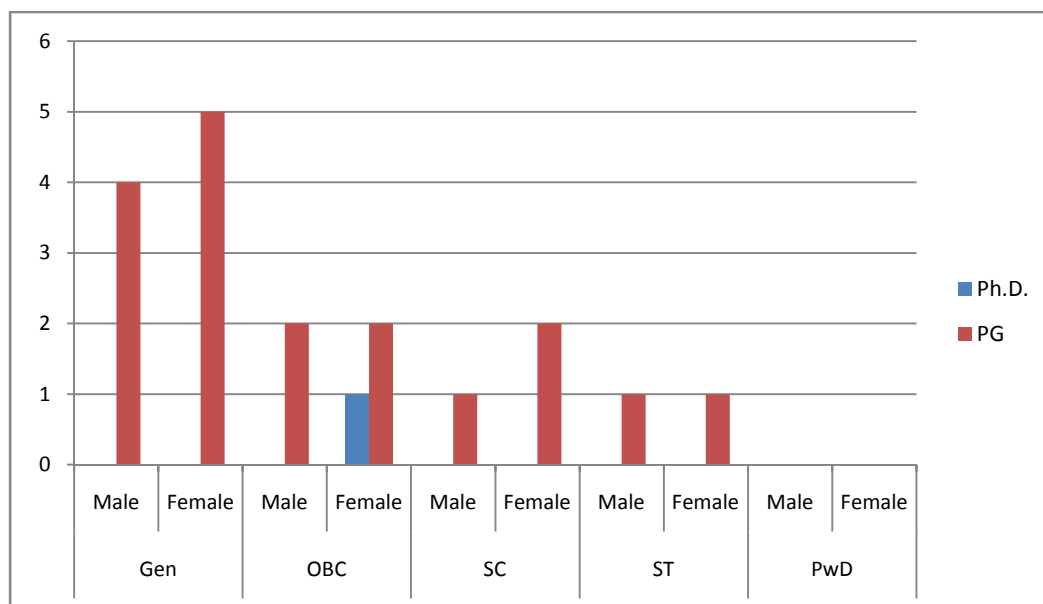

Student Enrollment for the Department

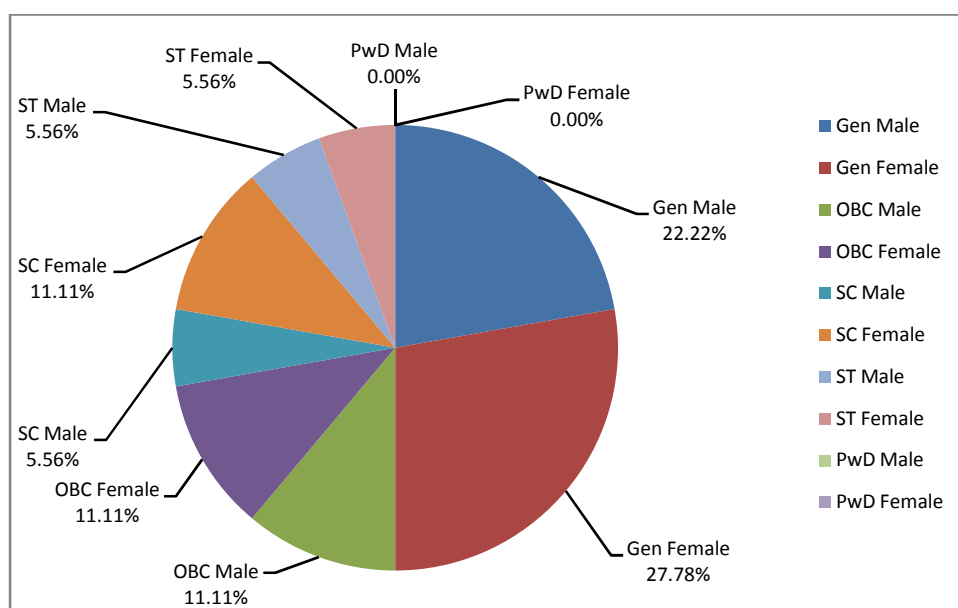

Gender wise distribution of Students

Seminars/Workshops/Conferences conducted by the Department/Centre:

S. No.	Name of the Seminar/workshop/conference	National / International	Duration and dates	Funding/sponsor Agency (ies)	No. of Participants	No. of Papers presented
1.	“Hands on Techniques used in Biotechnology”	National	17/12/2018 to 1/1/2019	DBT, New Delhi	21	NA

Training/orientation/refresher courses/special lectures conducted by the Department:

S. No.	Name of the course	Duration and dates	Funding/sponsor	Speakers
1.	Mushroom Production Training Programme for Farmers	31/1/ 2019	DBT	Prof. M.P. Singh, CBT, UoA
2.	Special Lecture on “Design Based Innovation Opportunity for UG PG Students in the university system”	11 th January 2019	DIC, UoA	Dr. Manish Arora, BHU
3.	Special Lecture on “Probiotics- An overview of beneficial effects on health and nutritional properties”	21 st August 2018	UOA	Prof. D.R. Modi, BBAU, Lucknow

Awards/Honours/Fellowship received:

S. No.	Name of Faculty Member/ Student who received award	Name of the award	Organization conferring award
1.	Prof. MP Singh	Fellow	AEB (Academy of Environmental Biology) on 3 rd October 2018
2.	Prof. M. P. Singh	International Travel Grant for attending conference in USA	SERB,DST, New Delhi

Funding received during the period (amount/purpose/agency) to the Department

S. No.	Agency	Purpose	Amount
1.	DBT	Scholarship, chemicals, maintenance and contingency	18.23 lakh
2.	UGC	lab grant	2.5 lakh

Proposed Projects/SAP Grants etc.

S. No.	Type of Project/grant	Title/Name	Duration	Proposed amount	Proposed or In process	Remarks
1.	Multi Institutional Research Project	Consortium for Pulmonary Delivery of Anti-Biofilm Agents and anti-TB Drugs for Concomitant MDR Mycobacterium tuberculosis Biofilm Disruption and Bactericidal Activity" LoI No:[1618]	3 Years	183 lakh	In Process	Final Presentation completed and Result awaited

Outreach activities:

S. N.	Name of Faculty Member/Student/ Researcher	Title of the paper presented	Title of Conference/Seminar etc	Duration of the conference/assignment	Organized by
1.	Prof. M.P. Singh	Chair the Session	Current Issues on Environmental Health, Climate change & its Management	3-4 October 2018	RML Awadh University, Faizabad
2.	Prof. M.P. Singh	Addressing malnutrition and environmental pollution through mushroom biotechnology	Current Issues on Environmental Health, Climate change & its Management	3-4 October 2018	RML Awadh University, Faizabad
3.	Prof. M.P. Singh	"Mushroom Biotechnology: From Fringe to Front	Orientation Course	9th October 2018.	HRDC, UoA
4.	Prof. M.P. Singh	Mushroom Biotechnology: the rise of fallen	AMI (Association of Microbiologists of India) Special Lecture	19th September, 2018	St. Joseph's College, Allahabad
5.	Prof. M.P. Singh	Mushroom: Best from Waste	AMI (Association of Microbiologists of India) Special Lecture	10th August, 2018,	Maha Prabhu Public School (MPPS), Allahabad
6.	Prof. M.P. Singh	Guest in valedictory function	119th Orientation Course	26th April 2018.	HRDC, University of Allahabad
7..	Dr. Awadh Bihari Yadav	As a discussant in Panelist Discussion	NanoMed-2018	16th April 2018	IIT Delhi and DBT New Delhi
8.	Dr. Awadh Bihari Yadav	As a discussant in Panelist Discussion	NANOBIOTECK - 2018	24th - 27th October 2018	AIIMS, IIT Delhi and DBT New Delhi
9.	Krishna Kumar Gupta	Heavy Metals remediation by Pleurotus Species	Recent Issues of Environmental Helath, climate Change and Its Managements (NCECM) & The Academy of Environmenal Sciences	Oct. 03-04th 2018	Dr. RML Avadh University Faizabad, India
10	Shweta Maurya	Biosynthesis of Silver Nanoparticles and its effect on Laccases activity (Poster presentation)	Recent Issues of Environmental Helath, climate Change and Its Managements (NCECM) & The Academy of Environmenal Sciences	Oct. 03-04th 2018	Dr. RML Avadh University Faizabad, India
11	Vivek Kumar Chaturvedi	Fungal Decolorization of Azo Dye by Extracellular Enzymes of Pleurotus Species (Poster presentation)	Yong Scientist Conference (YSC), IISF, Indira Pratishthan, Lucknow, 2018	Oct. 05-06th 2018	Ministry of Science and Technology, Ministry of Earth Sciences, New Delhi
12	Vivek Kumar Chaturvedi	Role of Intracellular Calcium in Microparticle Generation From Platelets (Poster presentation)	Recent Issues of Environmental Helath, climate Change and Its Managements (NCECM) & The Academy of Environmenal Sciences	Oct. 03-04th 2018	Dr. RML Avadh University Faizabad, India
13	Vivek Kumar Chaturvedi	workshop	Contaminated Sites: Assesment, Remediation and Risk	Nov 19th-23rd, 2018	GIAN-MHRD, MNNIT, Allahabad.
14	Aprajita Tiwari	The role of air pollutants in respiratory tract associated diseases and their antibiogram (Oral presentation)	Recent Issues of Environmental Helath, climate Change and Its Managements (NCECM) & The Academy of Environmenal Sciences	Oct. 03-04th 2018	Dr. RML Avadh University Faizabad, India
15	Sushil Dubey	Comparative study of antioxidant activity of Butea monosperma (Awarded Best Poster Presentation)	Recent Issues of Environmental Helath, climate Change and Its Managements (NCECM) & The Academy of Environmenal Sciences	Oct. 03-04th 2018	Dr. RML Avadh University Faizabad, India
16	Rupali Kaur	Poster Present. Phycobilioproteins: Potential	Prospects of rural prosperity and income security of farmers on the	16th-17th FEB 2019	BIOVED, Prayagraj BEST POSTER

S. N.	Name of Faculty Member/Student/Researcher	Title of the paper presented	Title of Conference/Seminar etc	Duration of the conference/assignment	Organized by
		Biomedical Applications to Drugs	occasion of kumbh mela A important step towards making India		PRESENTATION
17	Rupali Kaur	Poster Present: Phycobiliproteins : A Novel Source to Drugs	Current Trends In Drug Discovery Research	20th-22nd FEB 2019	CDRI, Lucknow
18	Rupali Kaur	Oral Present. Cyanobacteria: A Source Of secondary metabolites	NSFIST-2019	22th-24th FEB 2019	UNIVERSITY OF ALLAHABAD
19	Manjita Mishra	Oral Present. :Molecular Characterization of fungal root endophytes for saline stress (Bhuj, Gujarat)	NSFIST -2019	22th-24th FEB 2019	UNIVERSITY OF ALLAHABAD
20	Preeti Yadav	Preparation and Evaluation of antibacterial activity of Levofloxacin loaded chitosan-alginate composite nanoparticles against mastitis causing bacteria	NANOBIOTECK - 2018	24th - 27th October 2018	AIIMS, IIT Delhi and DBT New Delhi
21	Manish Gaur		Characterization of Nanomaterials	Feb 20-22, 2019	IITR Lucknow



Prof. M.P. Singh awarded 'FELLOW' by Director, NIPER, Raebareli, Vice-Chancellor, RML Awadh University, Faizabad and Director, IITR, Lucknow



AMI (Association of Microbiologist of India) local unit, Allahabad was inaugurated on 23rd April 2018 and Prof. M.P. Singh was nominated as Vice-President of AMI, local Unit.



Mushroom Production Training Programme for Farmers was organized on 31st January 2019.





DBT Sponsored Short term training program (STTP) for UG/PG Teachers on “Hands on techniques used in biotechnology” organised by Centre of Biotechnology



Special Lecture on “Design Based Innovation Opportunity for UG PG Students in the university system” organized by Centre of Biotechnology, Department of Biochemistry and Botany and talk delivered by Dr. Manish Arora, BHU on 11th January 2019.

CENTRE OF BIOINFORMATICS

Introduction:

The Centre of Bioinformatics was inaugurated in 2002. The Centre offers 4-semester (2 years) M.Sc. Program in Bioinformatics. Master in Bioinformatics program is quite unique; it is rigorous with its credit-based courses covering latest areas in Bioinformatics and Computational Biology. Specifically beneficial to the students from both Mathematics and Biological sciences streams, it is aimed at transforming students into trained Bioinformaticians with adequate theoretical and practical knowledge for investigating and addressing a number of key biological questions.

Thrust Areas:

- **Biological Physics:** Non-linear methods in the analysis of biological sequences.
- **Evolutionary Bioinformatics:** Molecular phylogeny, phylogenomics and phylogenetics incongruence.
- **Integrative Bioinformatics:** Integration, visualization and analysis of differential gene expression data.
- **Network Biology:** Prediction, modeling, and analysis of complex biological networks.
- **Pharmacogenomics:** Identification, characterization, and distribution pattern analysis of Single Nucleotide Polymorphism (SNPs) of pharmacogenomic importance. Structural and Functional effects of SNPs on drug metabolizer and transporter proteins.
- **Transcriptomics:** Genome-wide gene expression studies for characterization of Host-Pathogen interaction and drug target identification.

Programmes of Study :

S.No.	Programme of Study	Duration	No. of Seats	Specialization(s)
1.	Ph.D.	3-5 years (includes course work)	3	Bioinformatics
2.	M. Sc.	2 years	20	Bioinformatics

Faculty members and their Area of Research:

S.No.	Name of Faculty	Gender	Designation	Area of Specialization
1.	Dr. Anup Som	M	Assistant Professor	Network Biology, Evolutionary Bioinformatics & Computational Genomics
2.	Dr. M.P. Singh	M	Coordinator Prof., Biotech	Molecular Biology Mush. Biotechnology
3.	Dr. Pramod Katara	M	Assistant Professor	Computational Genomics and Transcriptomics

Support Staff:

S. No.	Name	Gender	Category	Designation	Work assigned
1.	Mr. Gyan Chandra	M	SC	Lab attendant	Lab attendant
2.	Mr. Bal Krishna Shukla	M	GEN	Peon	Attendant

Details of Students, Programme wise and Reservation wise (2018-2019):

Course	Gen			OBC			SC			ST			PwD			TOTAL			
	Male	Female	Total	Male	Female	Total	Male	Female	Total	Male	Female	Total	Male	Female	Total	Male	Female	Total	
Ph.D.	0	01	01	0	0	0	0	0	0	0	0	0	0	0	0	0	0	0	01
PG	3	4	0	0	0	0	0	1	0	0	0	0	0	0	0	0	0	0	08
Total	3	5	1	0	0	0	0	1	0	0	0	0	0	0	0	0	0	0	09

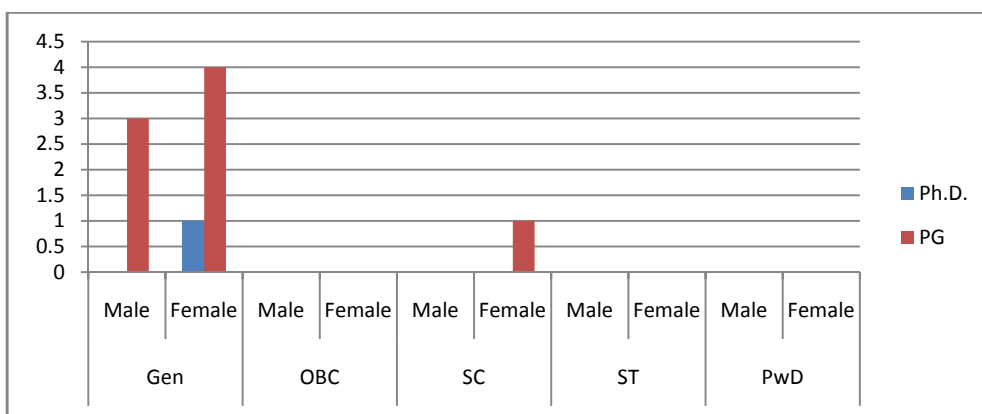

Student Enrollment for the Department

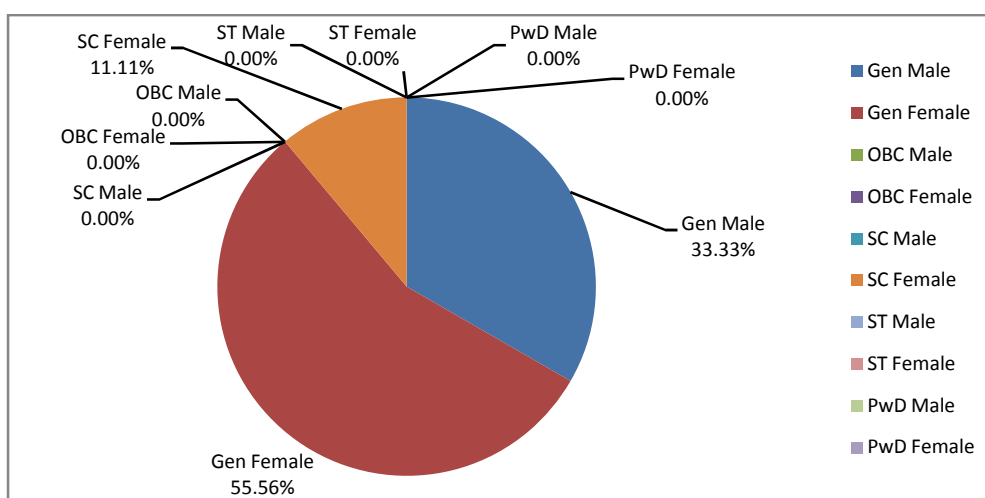

Gender wise distribution of Students

Training/orientation/refresher courses/special lectures conducted by the Department:

S. No.	Name of the course	Duration and dates	Funding/sponsor	Speakers
1.	Special Lecture on “Probiotics- An overview of beneficial effects on health and nutritional properties”	21st August 2018	University of Allahabad	Prof. D.R. Modi, BBAU, Lucknow

Awards/Honours/Fellowship received:

S. No.	Name of Faculty Member/ Student who received award	Name of the award	Organization conferring award
1.	Prof. MP Singh	Fellow	AEB (Academy of Environmental Biology) on 3 rd October 2018
2.	Prof. M. P. Singh	International Travel Grant for attending conference in USA	SERB,DST, New Delhi
3.	Prof. M.P. Singh	Vice-President, Association of Microbiologist of India, Allahabad Unit	AMI
4.	Ms. Anamika	Best Paper Award in ‘Genomics and Proteomics’	International conference on bioinformatics and system biology.Organiation: IIIT-A

Outreach activities:

S. N.	Name of Faculty Member/Student/Researcher	Title of the paper presented	Title of Conference/Seminar etc	Duration of the conference/ assignment	Organized by
1.	Prof. M.P. Singh	Chair the Session	Current Issues on Environmental Health, Climate change & its Management	3-4 October 2018	RML Awadh University, Faizabad
2.	Prof. M.P. Singh	Addressing malnutrition and environmental pollution through mushroom biotechnology	Current Issues on Environmental Health, Climate change & its Management	3-4 October 2018	RML Awadh University, Faizabad
3.	Prof. M.P. Singh	"Mushroom Biotechnology: From Fringe to Front	Orientation Course	9th October 2018.	HRDC, UoA
4.	Prof. M.P. Singh	Mushroom Biotechnology: the rise of fallen	AMI (Association of Microbiologists of India) Special Lecture	19th September, 2018	St. Joseph's College, Allahabad
5.	Prof. M.P. Singh	Mushroom: Best from Waste	AMI (Association of Microbiologists of India) Special Lecture	10th August, 2018,	MPP School (MPPS), Allahabad
6.	Prof. M.P. Singh	Guest in valedictory function	119th Orientation Course	26th April 2018.	HRDC, UoA
7.	Dr. PramodKatara	Session Chair "Genomics and Proteomics"	<i>International conference on 'bioinformatics and system biology'</i>	3 days (26-28th October, 2018)	IIIT-Allahabad
8.	Dr. PramodKatara	RNA-seq Data analysis for transcriptome profiling	Short term course on Next generation sequencing data analysis	7 days (17-23 rd , December, 2018)	MNIT-Allahabad
9.	Dr. PramodKatara	<i>In-silico</i> primer designing demonstration	Short term training course on " Hands on technique used in biotechnology"	15 days (17 Dec., 2018 to 1 st Jan, 2019)	University of Allahabad
10	Dr. PramodKatara	Protein-Protein Interaction to protein-interactome: Network approach	National symposium cum workshop on " Biomolecular Recognition and Dynamics"	3 days (11-13, Jan, 2019)	Banasthali University
11	Divya Mishra	In silico approach for mycoremediation of environmental toxicity	Current Issues on Environmental Health, Climate change & its Management	3-4 October 2018	RML Awadh University, Faizabad



Lecture Delivered by Prof. D.R. Modi



National Conference on Current Issues on Environmental Health, Climate change & its Management



AMI (Association of Microbiologist of India) local unit, Allahabad was inaugurated on 23rd April 2018 and Prof. M.P. Singh was nominated as Vice-President of AMI, local Unit

CENTRE FOR THEATRE & FILM

Introduction:

The department of Film and Theatre was established on 14th August 2010 as first Pan Asian Institute of this stream. It was inaugurated by Hon’ble Vice-chancellor Prof. RajanHarshe and co-coordinator Prof. SachinTewari, the founder members were Prof. SachinTewari, Prof. M. C. Chattopadhyaya and Prof. Lalit Joshi. The center has 10 seats for M.A. in Theatre and Film stream.

It caters to the students opting for Theatre and Film and has shown good promise in the past. Though there is no permanent faculty in the center, still it has performed up to mark and going from strength to strength. The center is rich with all professional equipment’s of film making and Theatre performance.

Thrust Areas:

- **Film stream**

Programmes of Study:

S. No.	Programme of Study	Duration	No. of Seats
1.	M.A. in Theatre and Film	2 years	10

Support Staff:

S.No.	Name	Gender	Category	Designation	Work assigned
1.	Sukeshkumar Tripathi	M	General	Jr. Office asst.	Office work
2.	Jai Prakash	M	ST	Technical asst.(Contract Basis)	Technical work
3.	ArjunLalYadav	M	OBC	Peon	Office work

Details of Students, Programme wise and Reservation wise (2018-2019):

Course	Gen			OBC			SC			ST			PwD			TOTAL		
	Male	Female	Total	Male	Female	Total	Male	Female	Total	Male	Female	Total	Male	Female	Total	Male	Female	Total
M.A. in Theatre and Film	06	00	06	00	01	01	01	00	01	00	00	00	00	00	00	07	01	08

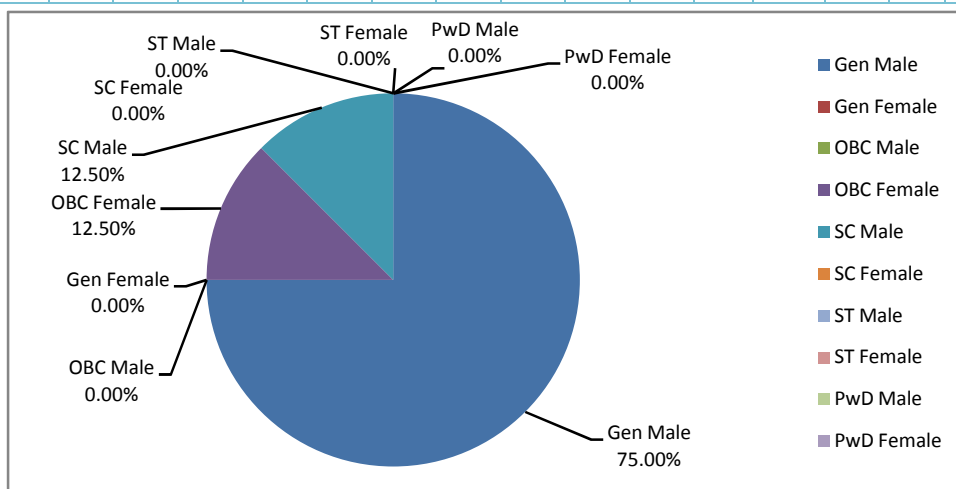

Gender wise distribution of Students

CENTRE FOR WOMEN'S STUDIES

Introduction:

The Centre for Women's Studies was sanctioned by the UGC in February, 2010. It was inaugurated on 6th of August, 2010 and soon after its establishment, a Finance Committee, a Steering Committee and a Board of Studies were constituted and a tentative plan regarding the activities of Centre was drawn up. The Centre offers a 3 months certificate course on Understanding Gender in Gender Studies and Masters Programme in Women's Studies.

Thrust Areas:

- Gender Studies
- Women & Society
- Women's Health & Development
- Women & Literature
- Gender Sensitization

Apart from these research and teaching activities, the Centre thrives in organizing various outreach programmes and projects in the abovementioned areas.

Programmes of Study:

S.No.	Programme of Study	Duration	No. of Seats
1.	Ph.D.	5 years(includes course work)	
2.	M. A.	2 YEARS	16
3.	3 Months Certificate Course on Understanding Gender	3 MONTHS	27

Faculty members and their Area of Research:

S.No.	Name of Faculty	Designation	Area of Specialization
1.	Dr. Anshu	Guest Faculty	Modern History & Extension of Women's Education in the Universities of the United Provinces 1919-1920.
2.	Gurpinder Kumar	Asst. Professor	Women's Studies, Gandhian Thoughts
3.	Smita Agarwal	Professor	Modern Poetry & Women's Studies

Support Staff:

S.No.	Name	Gender	Category	Designation
1.	Mr. Sudheer Kumar Gupta	M	OBC	Junior Office Assistant
2.	Mr. Dheeraj Gaud	M	OBC	Peon
3.	Bal Krishna	M	GEN	Professional Assistant
4.	Mr. Farhan Javed	M	OBC	Data Entry Operator

Details of Students, Programme wise and Reservation wise (2018-2019):

Course	Gen			OBC			SC			ST			PwD			TOTAL		
	Male	Female	Total	Male	Female	Total	Male	Female	Total	Male	Female	Total	Male	Female	Total	Male	Female	Total
PG	5	3	8	1	3	4	1	0	1	0	0	0	1	0	1	8	6	14
3 Months Certificate Course	2	5	7	3	5	8	6	3	9	0	1	0	0	0	0	11	14	25

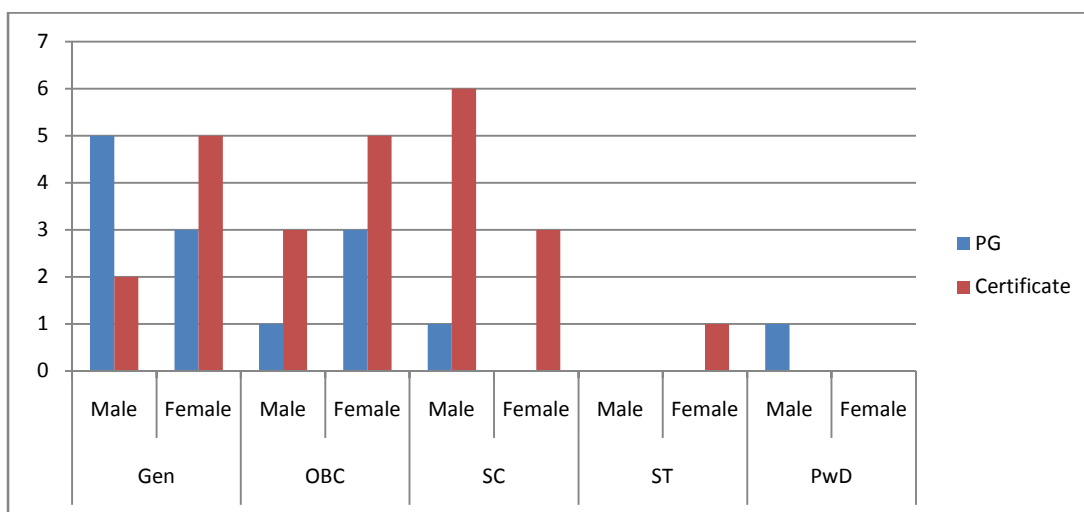

Student Enrollment for the Department

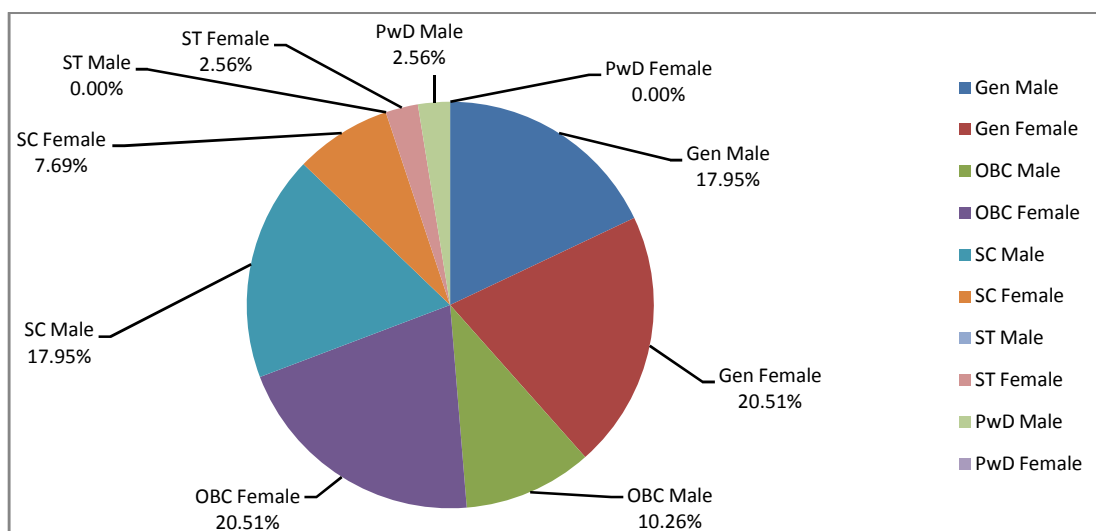

Gender wise distribution of Students

Seminars/Workshops/Conferences conducted by the Centre:

S. No.	Name of the Seminar/ workshop/conference	Duration and dates	No. of Participants
1.	Gender, Sexuality and Mental Health	One Day, 11 June 2018	30

Training/orientation/refresher courses/special lectures conducted by the Centre:

S.No.	Name of the course	Duration and dates	Speakers
1.	PG	One Day, 1 Nov. 2018	Prof. L.R. Sharma
2.	PG, Understanding Gender Course	One Day, 8 March 2019	Dr. Shilpi Mehrotra

Other publications by the Department/Centre

S.No.	Title	Type	Author(s)	Publication
1.	POSCO ACT	NEWSLETTER	C.W.S. AU	JULY 2018
2.	"#MeToo"	NEWSLETTER	C.W.S. AU	NOV. 2018
3.	WOMEN AND LAW	NEWSLETTER	C.W.S. AU	MARCH 2019

Other Activities:

S.No.	Title of Project	Duration	Principal Investigator
1.	A Survey Of Demonitization & Its Impact On Women Managing Households & Small Businesses In The Unorganised Sector	2018	PROF. SMITA AGARWAL

Proposed Courses

S. No.	Name of Programme	Nature	Duration	Proposed or In process
1.	B.A.	Bachelor Degree	3 Years	In process
2.	Pg Diploma	Diploma	1 Year	In process
3.	M.Phil.	Master Of Philosophy	2 Years	In process
4.	Ph.D.	Doctor Of Philosophy (Degree)	5 Years (Includes Course Work)	In process

Outreach activities:

S.N.	Name of Faculty Member/ Student/ Researcher	Title of the paper presented	Title of Conference/ Seminar etc	Duration of the conference/ assignment	Organized by
1.	Prof. Smita Agarwal	Changes reflected in the women of Uttar Pradesh.	Colloquium on the Changes Glimpsed in Asian women over the past decade	2 March, 2019	The Asia Research Project of the India International Centre, New Delhi
2.	Prof. Smita Agarwal	Woman-Centric Poems in English and Hindi	Life Time Achievement Award (International Women's Day)	7 March 2019	Hamidia Girls Degree College' Prayagraj
3.	Prof. Smita Agarwal	Women in conflict zones	International Women's Day. Emancipation: Issues and challenges	8 March 2019	ECC, Prayagraj
4.	Asst. Prof. Gurpinder Kumar	Understanding Gender and Sexual Harassment	Understanding Gender	01 February 2019	Gender Sensitization cell CMP Degree College, Prayagraj
5.	Dr. Anshu	Bhartiy Jati Vevastha me Stri Prashn (Dalit Stri ke Vishesh Sandarbh Me)	Problem of Caste in India: Investigating History and Historiography (National Seminar)	Two Days, 29 Nov. 2018	Department of Med./Mod. History
6.	Dr. Anshu	Kumbh Evm Nari Smutkarsh	Prayag Kumbha: Cultural Heritage of the World (Internation Seminar)	Two Days, 30 Nov. 2018	Samrat Harshvardhan Shodh Sansthan, Prayagraj
7	Dr. Anshu	Talk on women related survey reports. (Participated)	Engendering Budgets & Gender Inculsive Urban Development (Workshop)	Three days, 23-25 February 2019	AMU, Aligarh



1st Batch MA in Women's Studies Start in July, 2018



Hon'ble VC Distributing Certificates To 7th Batch "Understanding Gender Course" 26 Jan., 2019

Other information (about the Center)

- The Centre wishes to develop into a full fledged dept. of Women's Studies with undergraduate, postgraduate programmes as well as Ph.D in Women's Studies.

CENTRE FOR DEVELOPMENT STUDIES

Introduction:

Centre for Globalization and Development Studies is a pioneering centre to study and research phenomena and processes of globalization and development with inter-disciplinary approaches. Globalization is being viewed with varieties of perspectives ranging from epistemological, analytical and critical to grassroots civil society and public action across the world. Sometimes, it is simply viewed as polemic and semantic. Of late, this phenomenon has assumed enormous significance, which necessitates its critical examination from multi-disciplinarian perspectives as it tends to influence each and every domain of our life either in a minor or major way. This is also seen as a shaping factor of the world in the twenty-first century as it could lead to restructuring of the global order, economies and societies having implications on the overall development discourse/s, especially since the end of the cold war.

At the same time, contemporary ideas of development are also undergoing process of redefinitions in all fields of intellectual enquiry as well as leading to debates and dissents. These processes affect not only economic development of the countries through integration of capital but also bear implications for human development, discourses of rights and entitlements and boundaries of nation-states.

Furthermore, it is equally important to get engaged from the point of the developing societies like india and others. Currently, these societies are undergoing various processes of transformation that require in-depth enquiry so as to understand its relevance not only for academicians, researchers and policy makers but also for general people at large.

Thrust Areas:

- Globalization as a historical process across the world
- Socio-eco-political and regional linkages of globalization and development, especially in the developing societies
- Planning (Rural and Urban) vis-à-vis globalization and development
- Tribal societies, globalization and development
- State, Civil Society, Globalization and Development
- Democracy, Globalization and Development
- Social Movements, Globalization and Development
- Gender, Globalization and Development
- International Finance, Trade and Transport
- Regional Integration and Development
- Area Studies in Asia, Africa and Latin America
- Labor and Migration
- Human Development
- Rights and Entitlements
- Environment, Ecology and Climate Change
- Poverty and Inequality
- Identity and Conflict
- Corporate, Globalization and Development
- Multi-culturalism
- Cosmopolitanism and Nation-states

Programmes of Study:

S.No.	Programme of Study	Duration	No. of Seats	Specialization(s)
1.	Ph.D.	5 years (includes course work)	As per UGC rules/ guidelines	Inter-disciplinary thrust on Development Studies
2.	Master in Development Studies (Integrated)	Four Semesters	Twenty	None
3.	Masters in Development Studies	Four Semesters	Twenty	Development Studies

Faculty members and their Area of Research:

S.No.	Name of Faculty	Designation	Area of Specialization
1.	Dr. Angira Sen Sarma	Assistant Professor	Indian Foreign Policy, Energy Politics, Global Governance, Public Policy
2.	Dr. Pradeep Kumar Sharma	Associate Professor & Coordinator	Democracy, Decentralization, Social Movements, Agrarian Studies, Land Reforms, National and International Policies on Trade and Agriculture, Tribal Studies, Social Development, Civil

S.No.	Name of Faculty	Designation	Area of Specialization
			Society, State Politics, Governance and public action
3.	Dr. Santosh Kumar	Assistant Professor	Health, Ethnicity, Conflict, Population, Regional Economics and Environment
4.	Dr. Subhash Shukla	Assistant Professor	Indian Foreign Policy, International Relations and Indian Political System
5.	Dr. Sumit Saurabh Srivastava	Assistant Professor	Gender Studies, Sociology of Development, Political Sociology
6.	Dr. V.P. Singh	Professor	RuralDevelopment, Globalization, Tribal Development, Media

Support Staff:

S.No.	Name	Gender	Category	Designation	Work assigned
1.	Rajendra Kumar Yadav	Male	OBC	Office Assistant	Performing all duties assigned to Office along with maintenance of Computer Lab and Library of the Centre & Day-to-day administrative activities
2.	Pankaj Kumar	Male	OBC	Peon	Support Staff

Details of Students, Year wise and Reservation wise (2018-2019):

Course	Gen			OBC			SC			ST			PwD			TOTAL		
	Male	Female	Total	Male	Female	Total	Male	Female	Total	Male	Female	Total	Male	Female	Total	Male	Female	Total
Ph.D.	4	9	13	5	1	6	2	0	2	0	0	0	0	0	0	11	10	21
PG (MDS)	3	2	5	5	1	6	5	0	5	0	0	0	0	0	0	13	3	16
MDS (Int.)	1	1	2	0	0	0	0	0	0	0	0	0	0	0	0	1	1	2
Total	8	12	20	10	2	12	7	0	7	0	0	0	0	0	0	25	14	39

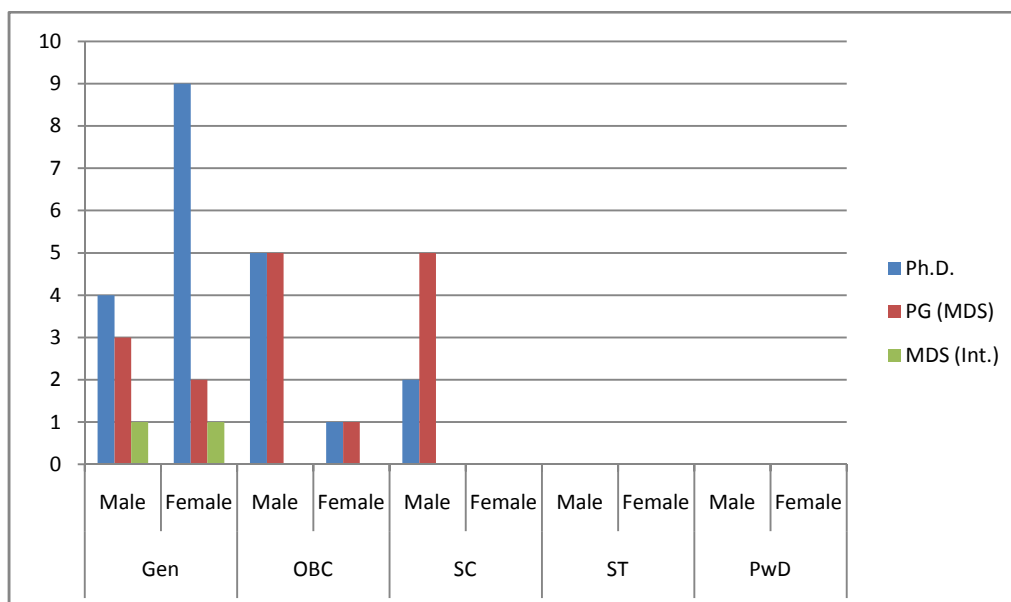

Student Enrollment for the Department

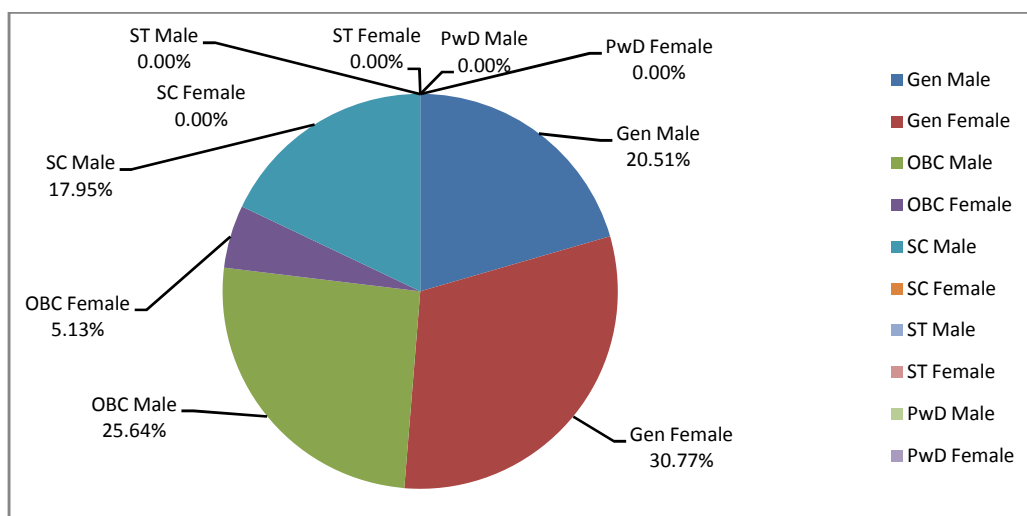

Gender wise distribution of Students

Awards/Honours/Fellowship received:

S.No.	Name of Faculty Member/ Student who received award	Name of the award	Organization conferring award
1.	Dr Pradeep K Sharma	Certificate of Appreciation in ‘Innovations and Good Practices in Institutional Governance of Higher Education’	NUEPA, New Delhi in March 2019

Outreach activities:

S. N.	Name of Faculty Member/Student/ Researcher	Title of the paper presented	Title of Conference/Seminar etc.	Duration of the Assignment	Organized by
1.	Prof. V.P. Singh	Globalization, Social Media and Cultural change in India	International Conference on Social Change and Challenges in the Era of Globalization	September 27-29, 2018	Department of Sociology, Ranchi University, Ranchi
2.	Prof. V.P. Singh	Globalization and Culture: Conceptual Issues	RC 14 Globalization and Culture at 44th All-India Sociological Conference, Mysore	December 27-29, 2018	St. Philomena’s College, Mysuru
3.	Prof. V.P. Singh	Globalization, Climate Change and Sustainable Development	National Seminar on “Environment, Technology and Sustainable Development: Issues and Challenges”	Feb. 22-23, 2019	Department of Sociology, DeenDayal Upadhyaya Gorakhpur University, Gorakhpur, Uttar Pradesh
4.	Dr. Subhash Shukla	Role of caste in Indian Politics: An Overview (Lecture)	National Seminar on Caste, Democratic Politics and Nation Building: Issues, Challenges and Possibilities	21-22 February 2019	Iswar Saran Post Graduate College, University of Allahabad, Prayagraj
5.	Dr. Subhash Shukla	Emerging trends in Indian Politics since Independence (Lecture)	National Seminar on Emerging Trends of Indian Politics: Issues, Challenges and Possibilities	30-31 March 2019	Institute of Gandhian Thought and Peace Studies & Department of Political Science, UoA
6.	Dr. Sumit Saurabh Srivastava	Mapping the intersectionality: caste, gender and violence in India	Problems of caste in India: Investigating history and historiography	29-30 November 2018	Department of Medieval & Modern History, University of Allahabad
7.	Dr. Sumit Saurabh Srivastava	Interlinkages between Sanitation, Appropriate technology and Sustainable Development	Environment, technology and Sustainable Development: Issues and Challenges	22-23 February 2019	Department of Sociology, DDU Gorakhpur University, Gorakhpur, Uttar Pradesh
8.	Kriti Mishra (ICSSR Doctoral Fellow)	Sustainable Development Goals (SDG) and Sanitation: An overview and Assessment with Special Reference to India.	National Seminar on ‘Sociology of Sanitation’	25-27 June 2018	-do

S. N.	Name of Faculty Member/Student/ Researcher	Title of the paper presented	Title of Conference/Seminar etc.	Duration of the Assignment	Organized by
10.	Dr. Angira Sen Sarma	India and the Shanghai Cooperation Organization	National Seminar on Post-Cold War Grand Strategies in Eurasia: Implications for Central Asia and India	27-28 February 2019	MMAJ Academy of International Studies, Jamia Millia Islamia, New Delhi
11.	Dr. Angira Sen Sarma	Regional Cooperation for Afghanistan: Opportunities and Challenges	International Conference on Ganga to Volga: India's Connectivity with Inner Asia	6-7 March 2019	Centre for Inner Asian Studies, School of International Studies, Jawaharlal Nehru University, New Delhi
12.	Neha Singh (Ph.D. Scholar)	An Introduction to Social Media and Its Socio-cultural Impacts on the Society	National Conference on 'Impact of Social Change and Technology on Family and Community' (ICSSR sponsored)	11-12 th March, 2019	Department of Home Science, Mahila Mahavidyalaya, Banaras Hindu University, Varanasi
13.	Neha Singh (Ph.D. Scholar)	"New Communication Technologies, Social Media and its Impacts on Indian Politics"	National Seminar on "Emerging Trends of Indian Politics-Issues, Challenges and Possibilities" (ICSSR sponsored)	30-31 st March, 2019	Institute of Gandhian Thought and Peace studies and Department of Political Science, UoA, Prayagraj
14.	Kriti Mishra (ICSSR Doctoral Fellow)	--	Research Methodology Course: Focus on Computer Applications	October 24 to November 02 2018	Babasaheb Bhimrao Ambedkar University, Lucknow and Association of the Socio-Economic Development Studies (ASEDS)
15.	Kriti Mishra (ICSSR Doctoral Fellow)	--	Two Day Workshop on How to Write Social Stories	November 19-20, 2018	G.B. Pant Social Science Institute, Jhusi, Prayagraj
16.	Neda Fatima (Research Scholar)	--	Research Methodology Course: Focus on Computer Applications	October 24 to November 02 2018	Babasaheb Bhimrao Ambedkar University, Lucknow and Association of the Socio-Economic Development Studies
17.	Neda Fatima (Research Scholar)	--	Two Day Workshop on How to Write Social Stories	November 19-20, 2018	G.B. Pant Social Science Institute, Jhusi, Prayagraj

Invited Lectures:

S. No.	Name of Faculty Member/ Student/ Researcher	Title of Lecture / Academic Session	Title of Conference / Seminar etc.	Organized by
1.	Dr. Sumit Saurabh Srivastava	Understanding new dimensions of gender & sexuality & LGBT (August, 2018)	Understanding Gender	Centre for Women's Studies, University of Allahabad, Allahabad, Uttar Pradesh
2.	Dr. Sumit Saurabh Srivastava	Understanding development: Dynamics and trajectory [15 February 2019]	Invited Lecture	Department of Sociology, Maulana Azad National Urdu University, Hyderabad in collaboration with RC-26: Minority Studies, Indian Sociological Society (ISS)

K. BANERJEE CENTRE OF ATMOSPHERIC AND OCEAN STUDIES

Introduction:

Research in the area of climate dynamics and mathematical modeling has started in the kbcaos and mnscoss in the year 2000 with the generous support from the ncaor, goa/moes, and isro, goi.in 2009, KBCAOS was established by the ugc as the centre with potential of research excellence with 7 permanent teaching positions. The teaching course (M.Tech. in ESS) and research programme (Ph.D.) Of the centre are designed in such a way so that it develops a deep understanding of the fundamental principles of atmospheric and ocean sciences alongwith creating innovative ability to solve new and challenging problems. Successful implementation of research projects based on observational and modeling studies with funding of more than rs. 10.00 crores has been carried out. The centre has received the dst-fist grant of Rs. 1.17 crores for procurement of instruments related to land-atmosphere interaction and hydrological research and for infrastructural development.

Thrust Areas:

- Quality Teaching and Research (M.Tech., Ph.D., Outreach)
- Atmosphere-Land-Ocean Modeling
- Indian Monsoon Prediction And Predictability
- Chaos and Nonlinear Dynamics
- Data Assimilation
- Remote Sensing and GIS
- Support to IMD/MOES in Lightning Prediction

Programmes of Study:

S. No.	Programme of Study	Duration	No. of Seats	Specialization(s)
1.	Ph.D. (Atmospheric and Ocean Sciences)	5 years (including course work)	12	Atmospheric and Ocean Science, Remote Sensing, Water Resources, Land use change dynamics
2.	M.Tech. (Earth System Sciences)	2 years (04 Semester)	15	Atmospheric and Ocean Science

Faculty members and their Area of Research:

S. No.	Name of Faculty	Gender	Designation	Area of Specialization
1.	Dr. A.C.Pandey	Male	Professor	Ocean Circulation Modeling, Non Linear dynamics, data diagnostic studies for climate research, climate change
2.	Dr. Shailendra Rai	Male	Associate Professor	Ocean Circulation Modeling, Predictability of Coupled Models
3.	Dr. Subhadeep Halder	Male	Assistant Professor	Land-Climate Interactions, Variability and Predictability of Monsoon, Climate Modeling
4.	Dr. Sudhir Kumar Singh	Male	Assistant Professor	Remote Sensing & GIS Applications in Water Resources and Environmental Pollution
5.	Dr. Suneet Dwivedi	Male	Professor	Predictability of Atmosphere and Ocean, Atmosphere-Ocean Circulation Modeling & Data Assimilation, Chaos and Non-Linear Dynamics
6.	Dr. Vivek Kumar Pandey	Male	Assistant Professor	Ocean Modeling and Dynamics of Indo- Pacific Ocean

Support Staff:

S. No.	Name	Gender	Category	Designation	Work assigned
1.	Mr. Vibhuti Pandey	Male	GEN	Clerk	Office work (Administrative)

S. No.	Name	Gender	Category	Designation	Work assigned
2.	Mr. Harikesh Singh	Male	GEN	Peon	Office work
3.	Mr. Akash	Male	GEN	Peon	Office work

Details of Students, Programme wise and Reservation wise (2018-2019)

Course	Gen			OBC			SC			ST			PwD			TOTAL		
	Male	Female	Total	Male	Female	Total	Male	Female	Total	Male	Female	Total	Male	Female	Total	Male	Female	Total
Ph.D.	03	03	06	02	01	03	02	00	02	00	00	00	00	00	00	07	04	11
PG	02	00	02	07	02	09	00	00	00	00	00	00	00	00	00	09	02	11
Total	05	03	08	09	03	12	02	00	02	00	00	00	00	00	00	16	06	22

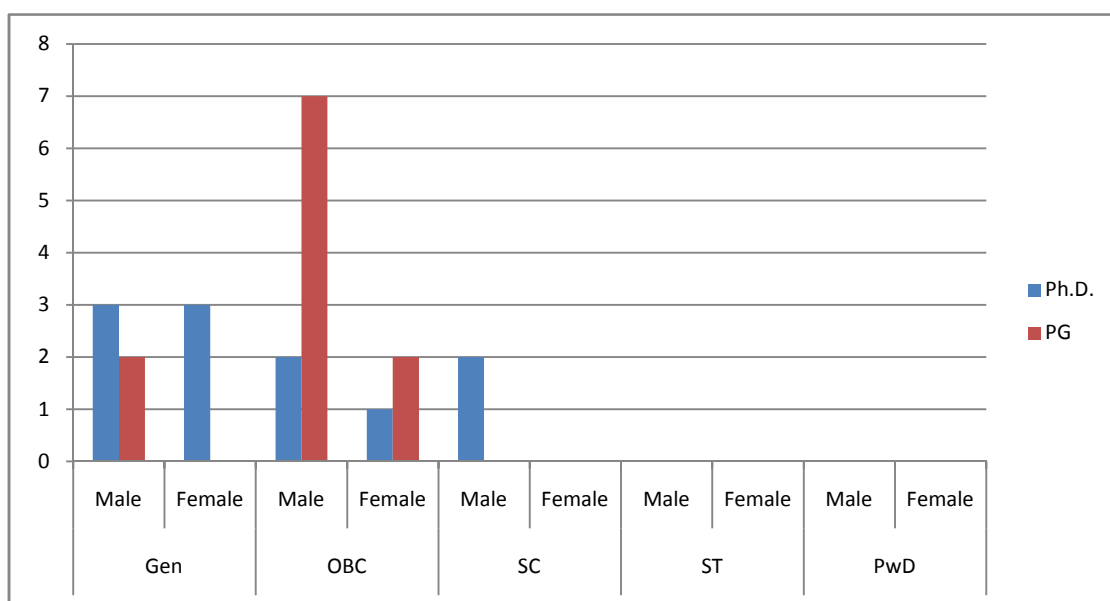

Student Enrollment for the Department

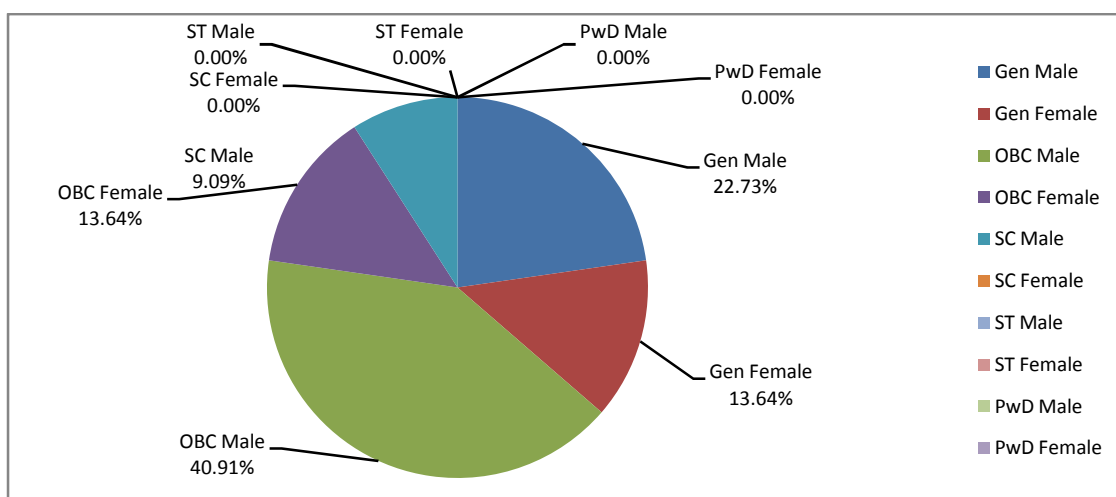

Gender wise distribution of Students

Training/orientation/refresher courses/special lectures conducted by the Centre:

S.No.	Name of the course	Duration and dates	Speakers
1.	Invited talk on 'Opportunities in Atmosphere-Ocean Research'	05 July 2018	Prof. P. C.Pandey
2.	Invited talk on 'Climate Services in India'	13 Feb 2019	Prof. AjitTyagi

Awards/Honours/Fellowship received:

S.No.	Name of Faculty Member/Student who received award	Name of the award	Organization conferring award
1.	Prof. A. C.Pandey	Director, Inter University Accelerator Centre (IUAC), New Delhi	UGC
2.	Prof. Suneet Dwivedi	Humboldt Fellowship for Experienced Researchers, Max Planck	Alexander von Humboldt (AvH) Foundation, Germany
3.	Prof. Suneet Dwivedi	INSA-DFG Visiting Professor, University of Hamburg, Germany	INSA, India and DFG, Germany
4.	Prof. Suneet Dwivedi	Visitor's Nominee in the Court of NEHU, Central University	Hon'ble President of India
5.	Dr. Shailendra Rai	Fulbright Fellowship for Academic and Professional Excellence to visit Lamont Doherty Earth Observatory, Columbia University, USA	USIEF, USA
6.	Dr. Shailendra Rai	Regular Associate, ICTP, Italy	ICTP, Italy
7.	Dr. Subhadeep Halder	Selected among global participants to develop a MOOC for the <i>Open Education for a Better World mentoring program</i> on the topic "Climate Change: Adaptation and Mitigation strategies for a better future"	The UNESCO and the UNSECO Chair at the Jozef Stefan Institute, Ljubljana, Slovenia.
8.	Dr. Subhadeep Halder	Mentor for the Indian Science Academies' Summer Research Fellowship program, 2019	Indian Academy of Science, Bangalore

Funding received during the period (amount/purpose/agency) to the Centre

S. No.	Agency	Purpose	Amount
1.	DST-FIST	Equipment/Infrastructure upgradation	Rs. 1.37 Crores
2.	University of Allahabad	Equipment/Lab Grant	Rs. 1.00 lakh

Future Projections

- ❖ To carry out the hydrological impacts investigation of land use/land cover change and climate variability in headwater region of a typical humid subtropical inland river basin.
- ❖ To combine land use models (Markov chain, Dyna-CLUE) with hydrological model (SWAT, VIC) to understand the water availability
- ❖ To perform model based sensitivity experiments to understand sources of errors in the simulation of monsoon and to develop land surface/boundary layer/shallow convection/convective triggering schemes using observations/modeling to reduce such errors.
- ❖ To explore potential impacts of climate change using land use patterns and hypothetical climate scenarios established on the basis of analyzing long-term climatic observations.
- ❖ To develop stochastic climate model for the prediction of extreme rainfall events.
- ❖ To configure regional earth system model (atmosphere-ocean-land-biosphere) over the Indian sub-continent region for improved seasonal prediction of Indian monsoon rainfall.
- ❖ To configure malaria model over the Indian region for assessment of impact of climate change in the malaria transmission in the next 4-5 decades.
- ❖ To develop ocean sea-ice biogeochemical modeling and assimilation setup

Outreach activities:

S.N.	Name of Faculty Member/Student/Researcher	Title of the paper presented	Title of Conference/Seminar etc	Duration of the conference/assignment	Organized by
1.	Suneet Dwivedi	Indian Summer Monsoon Rainfall in a Warming Environment	UGC-HRDC Orientation Course	28 Feb 2019	University of Allahabad, Allahabad
2.	Suneet Dwivedi	Energetically consistent Stochastic and Deterministic Kinetic Energy Backscattering in an Atmospheric Model	University of Hamburg Weekly Seminar	11 Dec 2018	Theoretical Meteorology Group, University of Hamburg, Hamburg, Germany
3.	Vivek Kumar Pandey	Volume transport of Indian Ocean and Indonesian throughflow region in a fine resolution ocean model of 1/12 degree	International Conference of International Academy of Physical Sciences, (CONIAPS-XXII)	13-15 Apr 2018	Dr. R. M. L. Avadh University, Faizabad
4.	Vivek Kumar Pandey	Volume and heat transport of Indonesian throughflow using a fine resolution ocean model	National Symposium on Understanding Weather and Climate Variability	24-27 Oct 2018	Banaras Hindu University
5.	Vivek Kumar Pandey	Evaluation of regional climate model in simulating the Indian Summer Monsoon over India	International Seminar on Environmental issues and Challenges in the 21st Century	20-22 Jan 2019	Department of Environmental Science, Bareilly College, Bareilly
6.	Vivek Kumar Pandey	Historical simulation of Indian summer Monsoon rainfall, : Emphasis on India and neighbourhood(CCIVA)	International Conference on Climate Change Impacts, Vulnerabilities, and Adaptation	26 Feb - 2 Mar 2019	IIT Kharagpur, India
7.	Sudhir Kumar Singh	Academia Meet	Annual Feedback session of IIRS Outreach Networked Institutions-Govt. of India Indian Space Research Organization	14-15 Mar 2019	Indian Institute of Remote Sensing, Dehradun, Uttarakhand, India
8.	Subhadeep Halder	Role of land surface initialization in sub-seasonal to seasonal scale forecasts	TROPMET Symposium at the Banaras Hindu University, Varanasi, UP	24-27 Oct 2018	Indian Meteorological Society
9.	Devanshu Kanaujia and Subhadeep Halder	Role of land-atmosphere interactions in convection and precipitation	TROPMET Symposium at the Banaras Hindu University, Varanasi, UP	24-27 Oct 2018	Indian Meteorological Society
10.	Ajay Kumar and Subhadeep Halder	Cloud-radiation interactions over the Indian region	TROPMET Symposium at the Banaras Hindu University, Varanasi, UP	24-27 Oct 2018	Indian Meteorological Society
11.	Dr. Subhadeep Halder, D. Kanaujia and M. Halder	On the role of land-atmosphere interaction in the simulation of Thunderstorms	International Conference on Thunderstorm and Lightning in Tropics, 2019	17-19 Jan 2019	Odisha State Disaster Management Authority, Centre for Env. & Clim., Dept. of Civil Eng., Siksha 'O' Anusandhan, Odisha
12.	M. Halder, Subhadeep Halder, S.D. Pawar, P. Mukhopadhyay, R. Kanase and A. C. Pandey	An Approach to predict Lightning using WRF Cloud Resolving Simulation	-do	17-19 Jan 2019	-do-
13.	P. Mukhopadhyay, M. Halder, Subhadeep Halder, A.C. Pandey et. al.	Latest approaches of Thunderstorm/Lightning and severe weather forecasting using highresolution numerical model	-do-	17-19 Jan 2019	-do
14.	Alok Kumar Mishra	Simulation of Contrasting Progression Phase of Indian Summer Monsoon During June 2013 and 2014 in RegCM4.5	CONIAPS XXII on Emerging Trends in Physical Sciences	13-15 April 2018	Dr. Ram Manohar Lohia Avadh University, Faizabad
15.	Alok Kumar Mishra	Ninth ICTP Workshop on the Theory and Use of Regional Climate Model	ICTP Italy	May 23- June 8, 2018	ICTP, Trieste, Italy
16.	Lokesh Kumar Pandey	Analyzing the role of different vertical parameterization schemes over the Tropical Indian Ocean	International Conference of International Academy of Physical Sciences (CONIAPS XXII) on Emerging Trends in Physical Sciences	13-15 Apr 2018	R. M. L. University, Faizabad

S.N.	Name of Faculty Member/Student/ Researcher	Title of the paper presented	Title of Conference/Seminar etc	Duration of the conference/ assignment	Organized by
17.	Lokesh Kumar Pandey	Participation	International Workshop on "Cloud Dynamics, Micro physics and Small-Scale Simulation"	13-17 Aug 2018	Indian Institute of Tropical Meteorology (IITM), Pune
18.	Lokesh Kumar Pandey	Simulation of Tropical Indian Ocean using the High Resolution Regional Ocean Model	Young Scientist Conference	5-8 Oct 2018	India International Science Festival (IISF)-2018, Lucknow
19.	Lokesh Kumar Pandey	Participation	Science and Training Workshop on Climate Change over the High Mountains of Asia (HMA)	8-12 Oct 2018	Indian Institute of Tropical Meteorology (IITM), Pune
20.	Lokesh Kumar Pandey	Estimating the Role of Mixed Layer Eddies in the Tropical Indian Ocean using High Resolution Ocean Model	TROPMET-2018 National Symposium on "Understanding Weather and Climate Variability: Research for Society"	24-27 Oct 2018	Banaras Hindu University, Varanasi
21.	Lokesh Kumar Pandey	Participation	Workshop on Best Practice in Scientific Publishing	20 Dec 2018	JK Institute of Applied Physics & Technology, UoA
22.	Pushpa Pandey	Visiting Fellow	International Centre for Theoretical Physics (ICTP), Trieste, Italy	15 Sept 2018 - 30 Nov 2018	International Centre for Theoretical Physics (ICTP), Trieste, Italy
23.	Pushpa Pandey	Variability in the Indian Summer Monsoon Rainfall and changes in the Tropospheric Temperature in a Global Warming Scenario	International Conference of International Academy of Physical Sciences (CONIAPS XXII) On Emerging Trends in Physical Sciences	13-15 Apr 2018	Dr. Ram ManoharLohiaAvadh University, Faizabad, India
24.	Shweta Chaturvedi	Effect of Changing Environment on Malaria Outbreak over the Indian Subcontinent	-do-	13-15 Apr 2018	Dr. Ram ManoharLohiaAvadh University, Faizabad
25.	Shweta Chaturvedi	Participation	International Workshop on Cloud Dynamics, Micro physics and Small-Scale Simulation	13-17 Aug 2018	Indian Institute of Tropical Meteorology (IITM) Pune
26.	Shweta Chaturvedi	Malaria Variability over the Indian Subcontinent using the Dynamical Disease Model	Young Scientist Conference	5-8 Oct 2018	India international Science Festival (IISF)-2018, Lucknow
27.	Shweta Chaturvedi	Participation	Science and Training Workshop on "Climate Change over the High Mountains of Asia (HMA)	8-12 Oct 2018	Indian Institute of Tropical Meteorology (IITM) Pune
28.	Shweta Chaturvedi	Investigating the Effect of ENSO Events on the Malaria Transmission over India	TROPMET-2018 National Symposium on Understanding Weather and Climate Variability: Research for Society	24-27 Oct 2018	Banaras Hindu University, Varanasi
29.	Shweta Chaturvedi	Participation	Workshop on "Best Practice in Scientific Publishing"	20 Dec 2018	JK Institute of Applied Physics & Technology, UoA
30.	Amita Singh	Quantifying Chlorofluoro Carbon (CFC-11, CFC-12) over the Indian Ocean using the ocean biogeochemical modeling	International Conference of International Academy of Physical Sciences (CONIAPS XXII)	13-15 Apr 2018	Dr. Ram ManoharLohiaAvadh University, Faizabad
31.	Amita Singh	Estimating Dissolved Oxygen in the Indian Ocean using Ocean Biogeochemical modeling in contrasting monsoon years	International Conference of International Academy of Physical Sciences (CONIAPS XXIII)	16-18 Nov 2018	Kathmandu, Nepal
32.	Shailendra Rai		WCRP Grand Challenges on Clouds, Circulation and Climate Sensitivity: 2nd Meeting on Monsoon and Tropical Rain Belts	2-5 July 2018	ICTP, Italy

S.N.	Name of Faculty Member/Student/Researcher	Title of the paper presented	Title of Conference/Seminar etc	Duration of the conference/assignment	Organized by
		South Asian summer monsoon predictability: An assessment of key teleconnections, their reproduction, and possible improvements	Ocean and Climate Physics, LDEO, Columbia University Seminar	11-05-2018	LDEO, Columbia University
33	Priya Patil and Shailendra Rai	Role of Indian and Pacific Ocean in subsurface variability in Southern Indian Ocean (SIO)	TROPMET-2018 National Symposium on Understanding Weather and Climate Variability: Research for Society	24-27 October 2018	Indian Meteorological Society at BHU Varanasi
34	N K Shahi and Shailendra Rai	Changing relationship of Southern Oscillation with Indian summer monsoon rainfall	TROPMET-2018 National Symposium on Understanding Weather and Climate Variability: Research for Society	24-27 October 2018	Indian Meteorological Society at BHU Varanasi

Other information (about the Center)

S. N.	Instrumentation, Computing and Networking facilities	Year of purchase (present status)
1.	Land-atmosphere interaction and Hydrological studies Test-bed (Funded Rs. 1.2 Crores under DST-FIST scheme 2018-2023) (i) Eddy-Covariance Flux Tower with data acquisition system (ii) Micrometeorological Sensors with Data acquisition system (iii) Soil moisture probe (COSMOS instrument for large-scale analysis as well as in-situ soil moisture probe) (iv) Hydra Probe (hand-held soil moisture measuring instrument) (v) Hydro Lab (vi) Atomic Absorption Photometer (vii) Portable Leaf Area Meter	Procurement is in process (2019)
2.	Measuring Instruments: Vaisala WXT520- 01 No., Rion NL42EX- 01 No., Graywolf Particle Counter PC-GW3016A- 01 No.	2014 (Working)
3.	Weather in a Tank Experimental set-up (from MIT, USA) for better understanding of the theory of general circulation	2015 (Working)
4.	Automatic Weather Station (measuring at 15 mins. interval) valuable for atmospheric research and model validation	2012 (Working)
5.	Linux High Performance Computing Clusters (4 in number) Several nodes (IBM/DELL/SGI machines), 100 processors (Intel), Red Hat Enterprise/Cent OS Linux, Infiniband switch	2010 (Working)
6.	SGI servers and workstations (64 bits RISC systems, IRIX 6.5 64 bit OS) Silicon Graphics (SGI) 2100 SMP server 4 X R12000 @350MHz MIPS, 4MB Sec CACHE, 8 GB RAM ext. to 16GB. SGI OCTANE II Workstation MIPS R12000A 360MHz, 1.5 GB RAM, ext. to 8GB, 2MB of sec. CACHE. SGI Tezro workstation Onyx3, Infinite performance fuel; 2 GB RAM	2003 (Limited Use)
7.	HP Workstations (i) C-3700: 750 MHz 8700 Processor/8 GB Ram/146 GB HDD/CD-RW/Fx10 (128 V MB RAM)/19 " Monitor/C++, Fortran Compilers (ii) C-3650: 650 MHz 8700 Processor / 2 GB Ram / 146 GB (iii) HP ZX 6000 Itanium: 2 x 1.3 GHz Itanium processors / 2 GB RAM / 73 GB HDD (iv) HCL core-2 duo personal computers (v) HP Proliant ML350: E5-2620 V4 8 Core 2.10 GHz Processor/16 GB RAM/ 3.6 TB HDD/C++ and Fortran Compilers	2006 (Limited Use) " " " 2017 (Working)
8.	Dell Workstations (2 Nos.) Dell Power Edge Server: E5-2695 v4 2.1 GHz Processor/ 640 GB RAM/ 120 TB HDD/ Microsoft Windows Server 2008 R2, 2012; Microsoft Windows HPC Server, Novell SUSE Linux Enterprise Server, Red Hat Enterprise Linux Vmware ESX/ Rocks Cluster with Open MPI, Fortran, GCC and SGE Compilers	2018 (Working)
9.	Campus is connected by LAN. Wi-Fi facility is also given by the University on a shared bandwidth of 1GBPS; in addition a Computer lab is being set-up in the Department and existing facilities being upgraded with support of DST-FIST funds	

CENTRE OF MATERIAL SCIENCES

Introduction:

Centre of Materials Sciences came into the existence in 2009. Centre is running M.Sc. in Materials Science and Ph.D. (Ph.D.) Programmes. Centre works in the interdisciplinary areas of physics, chemistry and engineering of materials (including bio-materials).

Thrust Areas:

- Soft Materials including Liquid Crystals and Bio Materials,
- Energy Materials,
- Multi Functional and Nano Materials

Programmes of Study:

S.No.	Programme of Study	Duration	No. of Seats	Specialization(s)
1.	Ph.D.	5 years (including course work)	35	Soft Materials including Liquid Crystals, Energy Materials, Multi Functional & Nano Materials
2.	M. Sc.	2 years (4 semesters)	15	1. Multifunctional Materials and Devices 2. Nanomaterials and Carbon Nanostructure 3. Liquid Crystal Materials for Displays 4. Magneto Resistive and Battery Materials

Faculty members and their Area of Research:

S.No	Name of Faculty	Designation	Area of Specialization
1.	Dr. Brajendra Singh	Assistant Professor	Materials Chemistry
2.	Dr. M. K. Singh	Assistant Professor	Multifunctional Multiferroic Materials, High K Materials, Raman Spectroscopy
3.	Dr. Prashant Dubey	Assistant Professor	Chemistry of Carbon and other Nanostructures
4.	Dr. Rajiv Giri	Assistant Professor	Superconductivity and Electron Microscopy
5.	Dr. RavindraDhar	Professor and Coordinator	Condensed Matter, Liquid Crystalline Materials, Nano Materials and Photovoltaic Materials

Support Staff:

S.No	Name	Gender	Category	Designation	Work assigned
1.	Mr. Ranjeet Singh Yadav	Male	OBC	Jr. Office Assistant	Office Work
2.	Mr. Pram Chandra	Male	OBC	Lab Attendant	Up keeping of the laboratory

Details of Students, Year wise and Reservation wise (2018-2019):

Course	Gen			OBC			SC			ST			PwD			TOTAL		
	Male	Female	Total	Male	Female	Total	Male	Female	Total	Male	Female	Total	Male	Female	Total	Male	Female	Total
Ph.D.	8	5	13	4	4	8	1	0	1	0	0	0	0	0	0	12	8	22
PG	11	5	16	3	3	6	0	1	1	0	0	0	0	0	0	13	9	23
Total	17	10	27	7	6	13	1	1	2	0	0	0	0	0	0	25	17	45

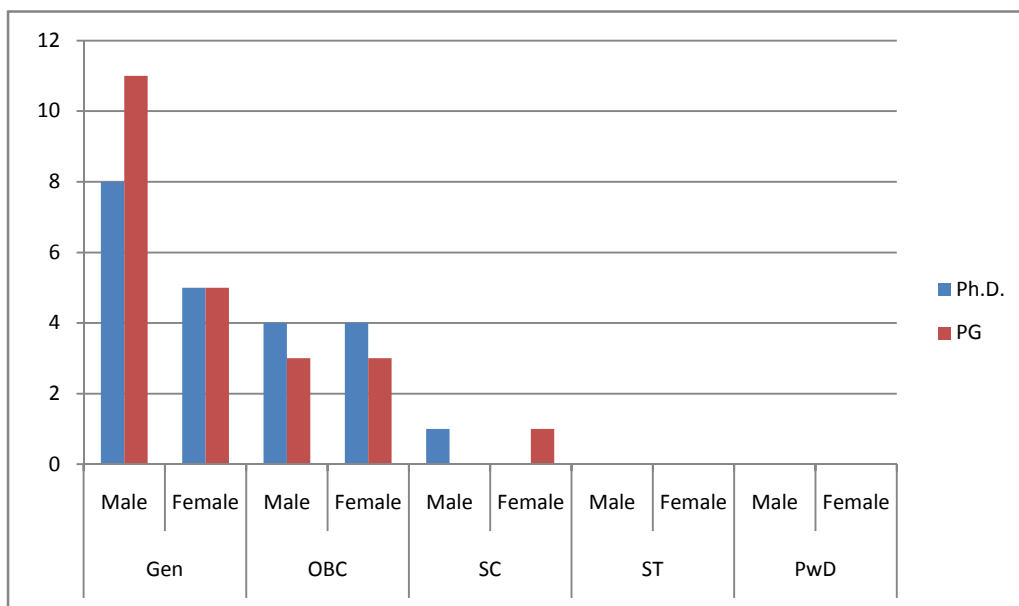

Student Enrollment for the Department

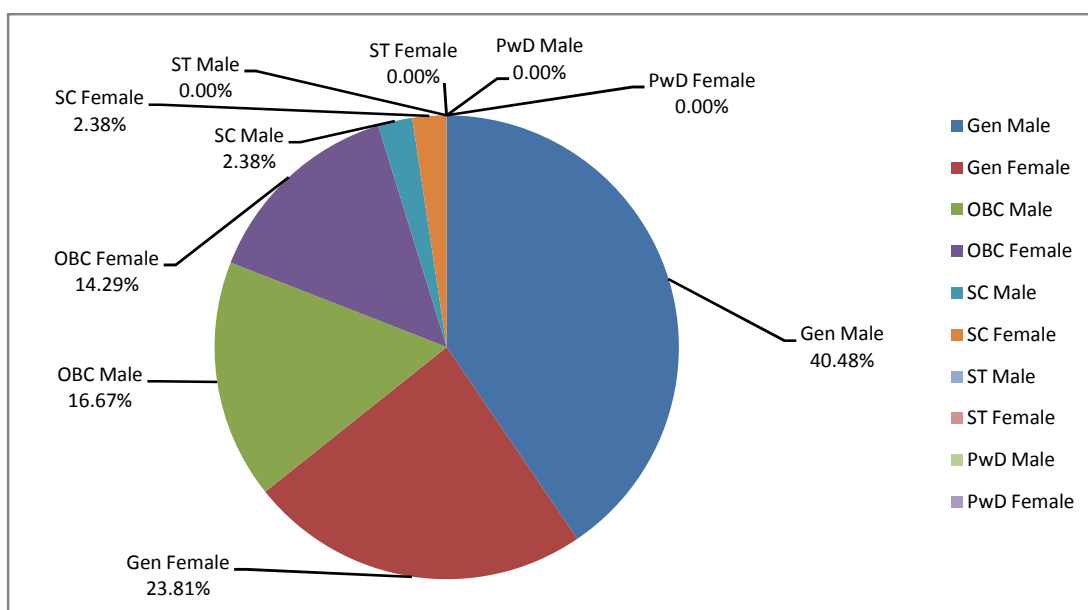

Gender wise distribution of Students

Seminars/Workshops/Conferences conducted by the Department/Centre:

S. No.	Name of the Seminar/workshop/conference	National / International	Duration and dates	Funding/sponsor Agenc(y/ies)	No. of Participants	No. of Papers presented
3.	25 th National Conference on Liquid Crystals	National	19-21 Dec 2018	DST, DBT, BRNS, CSIR and Indian Liquid Crystal Society	256	123

Training/orientation/refresher courses/special lectures conducted by the Centre:

S. No.	Name of the course	Duration and dates	Funding/sponsor	Speakers
1.	Nickel OctabutoxyPhthalocyanine and Nickel Octabutoxy Phthalocyanine/ Graphene Oxide Ultrathin Films: Enhancement of Negative Differential Resistance (Special Lecture)	Dec 22, 2018	University	Prof K A Suresh, CeNS, Bangalore

Awards/Honours/Fellowship received:

S.No.	Name of Faculty Member/ Student who received award	Name of the award	Organization conferring award
1.	Prof. Ravindra Dhar	Associate Fellowship	International Academy of Physical Sciences
		Fellowship	<u>Institution of Electronics and Telecommunication Engineers (IETE)</u> , New Delhi

Funding received during the period (amount/purpose/agency) to the Centre

S.No.	Agency	Purpose	Amount
1.	DST-FIST (Continued Programme)	Equipments etc	Rs. 1,15,000,00
2.	Department of Science & Technology (DST)	For 25th National Conference on Liquid Crystals	Rs. 2,00,000
3.	Department of Bio Technology (DBT)	For 25th National Conference on Liquid Crystals	Rs. 1,00,000
4.	Board of Research in Nuclear Science (BRNS)	For 25th National Conference on Liquid Crystals	Rs. 50,000
5.	Council of Scientific and Industrial Research (CSIR)	For 25th National Conference on Liquid Crystals	Rs. 50,000
6.	Lab Grant	From UGC/University	Rs. 1,00,000

Proposed Courses

S. No.	Name of Programme	Nature	Duration	Proposed or In process	Intake of Students	Remarks
1.	M. Tech.	Degree	2 years (4 Semesters)	Passed through various statutory bodies	15	To be run with the completion of necessary Infrastructure

Proposed Projects/SAP Grants etc.

S. No.	Type of Project/grant	Title/Name	Duration	Proposed amount (Rs)	Proposed or In process	Remarks
1.	SAP-UGC	SAP-UGC	5 years	1,20,000,00	In process	With UGC

Outreach activities:

S.N.	Name of Faculty Member/Student/Researcher	Title of the paper presented	Title of Conference/ Seminar etc	Duration of the conference/ assignment	Organized by
1.	RavindraDhar (Invited Talk)	Anti-ferroelectric liquid crystalline materials of mixed R-S enantiomers for high definition display application	XXIII Conference of International Academy of Physical Sciences, Kathmandu	16-18 Nov 2018	National Academy of Science and Technology, Nepal
2.	Brajendra Singh and AdityaTandon	Evidence of structural reorganization and change in dielectric constant by Fe doping at Ca site in hydroxyapatite	One Day National Seminar On New Materials & Applications (NSNMA -18)	October 13, 2018	Materials Research Society of India-Allahabad Chapter, University of Allahabad, Prayagraj-211002

S.N.	Name of Faculty Member/Student/Researcher	Title of the paper presented	Title of Conference/Seminar etc	Duration of the conference/assignment	Organized by
3.	Priyanka Singh and Brajendra Singh	Study of valence state of Fe in Zn _{0.95} Fe _{0.05} O by X-ray absorption spectroscopy	-do-	-do-	-do-
3.	Priyanka Singh and Brajendra Singh	Magnetic field dependent dielectric and magnetic field sensitivity behavior of Zn _{0.95} Fe _{0.05} O	Indus Synchrotrons Users' Meeting (ISUM-19)	March 27-29, 2019	Devi Ahilya Vishwavidyalaya, Indore; Raja Ramanna Centre for Advanced Technology, Indore and UGC-DAE Consortium for Scientific Research (CSR), Indore
4.	RavindraDhar (Invited Talk)	Liquid crystalline materials doped of nano particles nano tubes and quantum dots for various technological applications	22 nd International conference of International Academy of Physical Sciences (CONIAPS XXII)	April 13-15,2018	Faculty of Science Dr. Ram ManoharLohiaAvadh University, Faizabad.
5.	Deepa Singh and RavindraDhar	Effect of multi walled carbon nanotubes on electro-optical parameters of nematic liquid crystalline materials	-do-	-do-	-do-
6.	UpendraBahadur Singh and RavindraDhar	Influence of SWCNTs on electrical and electro-optical parameters of nematic liquid crystalline material	-do-	-do-	-do-
7.	NeelamYadavand RavindraDhar	Novel de Vries liquid crystals-dielectric and infrared spectroscopy	-do-	-do-	-do-
8	A. Khareand RavindraDhar	Application of liquid crystal and their nano-composites in organic photovoltaics	-do-	-do-	-do-
9.	PratibhaTripathi and RavindraDhar	Synthesis of silver nanoparticles by chemical methods and its effect on thermal and dielectrics behaviors of nematic liquid crystalline materials	-do-	-do-	-do-
10.	Rahul Uttam and RavindraDhar	Review on plasmonic nanoparticles	-do-	-do-	-do-
11.	RavindraDhar	Liquid crystals: Advance materials for devices and Bio-medical applications	25 th National Conference On Liquid Crystals	December 19-21,2018	Centre of Materials Sciences University of Allahabad
12.	NeelamYadavand RavindraDhar	de Vries characteristics in chiral Smectic A and C phases	-do-	-do-	-do-
13.	Abhay S. Pandeyand RavindraDhar	Functionalized single-walled carbon nanotubes dispersed in Liquid crystal: Interplay with molecular dynamics	-do-	-do-	-do-
14.	Mukesh Mishra and RavindraDhar	High concentration (3 wt %) of colloidal gold nanoparticles dispersed with discotic liquid crystalline material for Photovoltaic applications	-do-	-do-	-do-
15.	Amir Iqbaland RavindraDhar	Thermodynamic, optical and switching parameters of a ferroelectric liquid crystalline material having SmA*-SmC*-SmBh* phase sequence	-do-	-do-	-do-
16.	UpendraBahadur Singh and RavindraDhar	Dielectric and display parameters of liquid crystalline material dispersed with SWCNTs under bias electric field	-do-	-do-	-do-
17.	Deepa Singh and RavindraDhar	Enhancement in Orientational order of Nematic liquid crystal dispersed with multi -walled carbon nanotubes	-do-	-do-	-do-
18.	PratibhaTripathi and RavindraDhar	Effect of gold nano-particles on dielectric parameters and phase transition of room temperature nematic liquid crystals	-do-	-do-	-do-
19.	Praveen Kumar Singh and RavindraDhar	Effect of functionalization of multi walled carbon nanotubes on thermal, optical and textural properties dispersed in nematic liquid crystals (8CB)	-do-	-do-	-do-
20.	Rahul Uttam and RavindraDhar	Thermodynamical and UV-Visible study of a room temperature Discotics liquid Crystal doped with Ferroelectric nanoparticles.	-do-	-do-	-do-

S.N.	Name of Faculty Member/Student/Researcher	Title of the paper presented	Title of Conference/Seminar etc	Duration of the conference/assignment	Organized by
21.	A. Khare and RavindraDhar	Thermodynamical, electro-optical and dielectrics study of Gold Nanoparticles (GNP) Doped TriphenyleneDiscotic liquid crystal (DLC)	-do-	-do-	-do-
22.	Hajer H.M. Elkhali and RavindraDhar	Effect of dispersion of gold nano particles on phase transition, dielectric and electro-optical parameters of room temperature 4-(trans-4'-n-hexylcyclohexyl) isothiocyanatobenzoate (6 CHBT) liquid crystal.	-do-	-do-	-do-
23.	Dheeraj Kumar Pandey and RavindraDhar	Electrical and electro-optical properties Of Nematic Liquid Crystalline material and silver nano-particles composites	-do-	-do-	-do-
24.	SaikumarChirra and RavindraDhar	Thermodynamic characterization of a ferroelectric liquid crystalline material having ferroelectric SmC* Phase	-do-	-do-	-do-
25.	Rahul Uttam and K N Uttam	Label free mapping of the biochemicals in tomato fruit by confocal ramanmicrospectroscopy	-do-	-do-	-do-
26.	AartiJaiswal and K N Uttam	Synthesis of silver nanoparticles by green approach using rhizome of zingiberofficinale and its interactions with pomegranate juice	-do-	-do-	-do-
27.	PrashantDubey	Hydrothermally synthesized water-soluble carbon dots from natural source for imaging application	-do-	-do-	-do-
28.	Achal Singh Keshari and RavindraDhar	Synthesis and characterization of MnO ₂ nanomaterial as energy storage material via green approach	-do-	-do-	-do-
29.	Manoj K. Singh	Multiferroic properties, Strain and Temperature Induced Phonon shifts in Multiferroic and Ferromagnetic Heterostructured thin films	-do-	-do-	-do-
30.	Gulab Singh and Manoj K. Singh	Magneto-dielectric and Multiferroic properties of Bi _(1-x) Y _x FeO ₃ powder synthesized using sol-gel method	-do-	-do-	-do-
31.	Bushra Khan and Manoj K. Singh	Structural and dielectric Characteristic of 0.9BiFeO ₃ -0.1CaTiO ₃ Multiferroic composite synthesized by sol-gel method	-do-	-do-	-do-
32.	Anshu Kumar Singh and Rajiv Giri	Synthesis of graphene Based transparent conducting film for their use In optoelectronics device	-do-	-do-	-do-
33.	Aarti Jaiswal and K N Uttam	Green synthesis and optical Characterization of the silver nano particle and its application.	National Seminar on Future India: Science and Technology (NSFIST)	February 22-24, 2019	Allahabad Chapter Indian Science Congress Association
34.	Upendra Bahadur Singh and RavindraDhar	Electo-optic and Dielectric behavior of nematic liquid crystal with SWCNTs nanocomposites	-do-		
35.	A. Khare and RavindraDhar	Dielectric, optical and thermodynamics of high temperature discotic liquid crystal doped with capped gold nanoparticles	-do-	-do-	-do-
36.	Deepa Singh and RavindraDhar	Enhancement in Orientational order of Nematic liquid crystal dispersed with multi-walled carbon nanotubes	-do-	-do-	-do-
37.	Pratibha Tripathi and RavindraDhar	Effect of gold nano-particles on dielectric parameters and phase transition of room temperature nematic liquid crystals	-do-	-do-	-do-
38.	Praveen Kumar Singh and RavindraDhar	Dielectric, thermal, optical and textural study of nematic liquid crystal (NLCs) dispersed with pristine multi walled carbon nanotube (mWCNTs) and Functionalized MWCNTs	-do-	-do-	-do-
39.	Rahul Uttam and RavindraDhar	Discotic liquid crystal as apolymeric matrix for ferroelectric nanoparticles	-do-	-do-	-do-

S.N.	Name of Faculty Member/Student/Researcher	Title of the paper presented	Title of Conference/Seminar etc	Duration of the conference/assignment	Organized by
40.	Amir Iqbal and RavindraDhar	Switching, optical and Thermodynamical parameters of a ferroelectric liquid crystalline material having SmA*-SmC*-SmBh* phase sequence	-do-	-do-	-do-
41.	Dr. Rajiv Giri Invited talk	Surface modification of stainless steels for energy applications	National Conference on Advanced Nanomaterials and their Application	21-23 December 2018	Department of Physics, MNIT Allahabad, Prayagraj
42.	Anshu Kumar Singh, Raghvendra Prasad Singh and Rajiv Giri	Synthesis of P-type Graphene using common dopant FeCl ₃ /SnCl ₂ and N-type Graphene using hydrazine using novel synthesis route.	-do-	-do-	-do-
43.	Raghvendra Prasad Singh, Anshu Kumar Singh and Rajiv Giri	Investigation on Synthesis of Hybrid Film of Graphene With 2D SWNT/ MWNT Carbon Nanotube	-do-	-do-	-do-
44.	Anshu Kumar Singh, Raghvendra Prasad Singh and Rajiv Giri	Synthesis of Graphene based Transparent Conducting film for their use in Optoelectronic Device	25 th National Conference on Liquid Crystals	19-21 December 2018	Centre of Material Sciences, University of Allahabad, Prayagraj
45.	Prashant Dubey	<i>Chemical Functionalization of Carbon Nanostructures towards Water Solubilization for their possible Application</i>	National Seminar on New Materials & Applications	October 13, 2018	Materials Research Society of India-Allahabad Chapter, Allahabad
46.	Prashant Dubey	Hydrothermally synthesized water-soluble carbon dots from natural source for imaging application	25 th National Conference on Liquid Crystal	December 19-21, 2018	Centre of Material Sciences, University of Allahabad, Allahabad
47.	Gulab Singh	Effect on structural and multiferroic properties of (La, Co) co-substituted Bismuth Ferrite (best poster awards)	National Seminar on New Material and Application	October 13, 2018	Materials Research Society of India, University of Allahabad
48.	Aditya Kumar	Structural and dielectric characteristic of Ti doped SrSnO ₃	-do-	-do-	-do-
49.	Aditya Kumar	Structural, Raman and Dielectric Characteristic of CaSn _{0.95} Ti _{0.05} O ₃	National Conference on Liquid Crystal	21-23, December 2018	Centre of Material Sciences, University of Allahabad
50.	Manoj K Singh	Multiferroic properties, Strain and Temperature Induced Phonon Shift in Multiferroic and Ferromagnetic Heterostructured Thin Films	-do-	-do-	-do-
51.	Manoj K Singh	Multiferroic properties in Li _{0.1} Bi _{0.9} MnO ₃	National Seminar on New Material and Applications	October 13, 2018	Materials Research Society of India, University of Allahabad
52.	Bushra Khan	Dielectric and Impedance Characteristic of 0.9BiFeO ₃ -0.1CaTiO ₃ Multiferroic composite synthesized by sol-gel method	-do-	-do-	-do-
53.	Bushra Khan	Magnetodielectric and Multiferroic Properties of Bi _(1-x) Y _x FeO ₃ powder synthesized using sol-gel method	National Conference on Liquid Crystal	21-23, December 2018	Centre of Material Sciences, University of Allahabad

Other information (about the Department/Center)

Dr. Brajendra Singh

- Active collaboration with Raja Ramanna Centre of advanced Technology (RRCAT) Indore, India to utilize synchrotron radiation for electronic structure determinations and diffraction experiments.

Prof. RavindraDhar

- Member, Editorial Board, Phase Transitions, a Multinational Journal from Taylor & Francis, UK.
- Member Board of Studies Physics and Electronics, GGV Central University, Bilaspur.
- External Advisory Member SAP (UGC) to Applied Physics, Aligarh Muslim University, Aligarh.
- Science Popularization Programmes of the National Academy of Sciences (NASc), India.
- Lectures and Assessments as Mentor under DST INSPIRE programme in various institutions.
- Mentor and Judges to various scientific events of NASc, India and several other institutions.

- Active collaboration with, Military University of Technology, Warswa, Poland; Trinity College, University of Dublin, Ireland; Raman Research Institute, Bangalore and BHU, Varanasi India.



25th National Conference on Liquid Crystals during Dec 19-21, 2018: Release of souvenir.



Valedictory session of 25th National Conference on Liquid Crystals on Dec 21, 2018

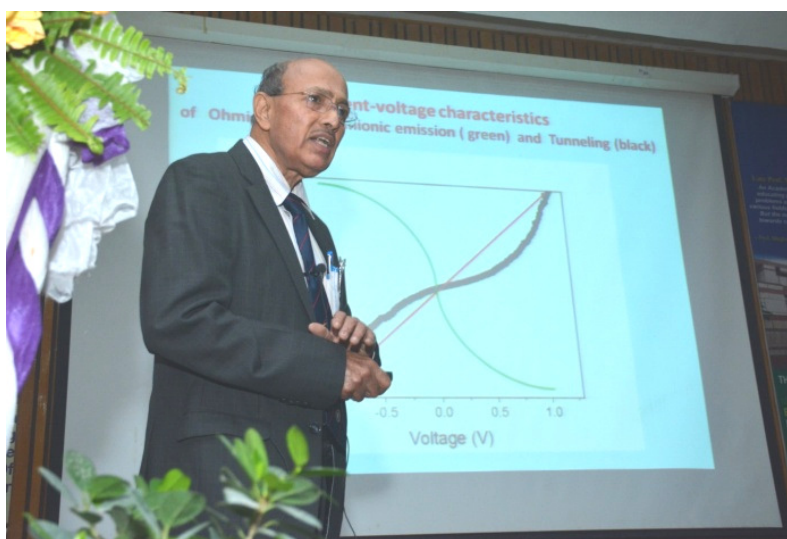

Prof. K. A. Suresh from Centre for Nano and Soft Matter Research, Bangalore while delivering a talk on Nickel OctabutoxyPhthalocyanine and Nickel OctabutoxyPhthalocyanine/Graphene Oxide Ultrathin Films: Enhancement of Negative Differential Resistance

NANO TECHNOLOGY APPLICATION CENTER**High Fluence Ion Beam Facility: Accelerator Center made functional****Introduction:**

The high fluence ion beam facility at University of Allahabad is fully operational and user experiments as well as in-house experiments by one PhD student were performed. The analyses of the experiments are in the process by users. Department of Science and Technology, New Delhi has sanctioned a project titled "Utilization of HIGH FLUENCE ION BEAM FACILITY (UHFIBF) vide letter no. SR/MF/PS-04/2017/G" worth a fund of INR ~4 Crore to run the facility.

Thrust Areas:

- The objective is to run the accelerator based research facility in Allahabad University using ECR ion source to create an environment for pursuing experimental work in interdisciplinary areas.
- Accelerator based laboratory will provide best possible environment for training human resource as it encompasses latest technologies such as data analysis, computer control, analog and digital instrumentation, Ultra high vacuum, etc.
- It will be gradually developed for providing opportunity to younger generation to get involved in projects involving state of the art technologies.
- An in-house facility of this type in the university will most certainly help in attracting students towards experimental sciences.

Faculty Members and their area of Research

S. No.	Name of the Faculty	Designation	Area of research
1.	Prof. Avinash C Pandey	Principal Investigator, NAC & HFIBF Adjunct Professor, Currently Director, Inter University Accelerator Centre, New Delhi	Theory, method development, and modeling of photonic, and nanoenergetic materials; theory and experimental studies of functional nanomaterials, nano-bio interface for molecular nanoelectronics and sensors applications besides understanding the effect of oceanic system memory having implications for weather, climate, and cryosphere

Support Staff

S.No.	Name	Designation	Gender/Categ.	Work assigned
1.	Dr. Vikas Baranwal	Scientist D	M (GEN)	User support for execution of experiments and planning of proposals
2.	Mrs. Jyotsna Das	Radiological Safety Officer/Project Assistant	F (GEN)	Radiation monitoring
3.	Mr. Sohan Lal Pradhan	Project Assistant	M (GEN)	Accelerator support
4.	Ms. Jigyasa Kumar	Project Assistant	F (GEN)	Accelerator support
5.	Mr. Rajkumar Dwivedi	Secretarial Assistant	M (GEN)	Administrative support
6.	Mr. Himanshu Mishra	Support Staff	M (GEN)	Administrative support

Summary of progress:**Research work done with the facility so far:**

1. Polymer and composites of Au-C₆₀, Au-Ag-C₆₀ deposited on glass, quartz and TEM grid was implanted with Ar⁸⁺ ions with 2.6 MeV energy and varying fluences from 1x10¹⁶ ions/cm² to 5x10¹⁶ ions/cm². The experiment was performed by the group of Dr. Rahul Singhal from MNIT, Jaipur. Total 21 samples were implanted during the experiment.
2. In-house experiment was performed for investigating the ion irradiation induced mutation on rice seeds. The experiment was carried out with Ar⁸⁺ ions with energy of 2.6 MeV and fluence of 5x10¹⁶ ions/cm². There are a number of chemical, biological, physical processes are available to induce mutation but recently ion beam technology emerged as a new form of physical mutagen for the induction of mutation in plants, to produce

new varieties of various plants, in place of X-rays, Y-rays, and neutrons. The main aim of ion beam induced mutation in plant breeding is to modify and develop Novel mutants (such as drought resistance, high productivity, high nutrient use efficiency etc.) and their related genes. This process is made possible due to high RBE (Relative Biological Effectiveness) of ion beams of growth inhibition, fatality etc. Most effective LET value for inducing mutant sectors without causing severe damage of genetic material is lies between (30-110 KeV/ μm). Results suggested that ion beam generate high mutation frequency (mutation causes deletion of several base pair long genetic material which results in irreparable DNA damage) as well as wide mutation spectrum.

The result of present experiment is yet to be analyzed.

3. Au/Si, Au/SiO₂, Ag/Si, Ag/glass, Polymer/Si, Au & Pd alloy/Si samples were implanted with Ar¹⁺, 120 keV; Xe⁸⁺ (~1.4 MeV) ions with varying fluences of 1×10^{14} , 1×10^{15} , 3.3×10^{15} , 1×10^{16} , 1×10^{17} ions/cm². The experiment was performed by the students of Prof. D K Avasthi, Amity University, Noida.

Conference presentations:

1. Oral presentation by Vikas Baranwal on XANES and XAFS studies of Ge ion implanted SiO₂ matrix: **Vikas Baranwal**, Parasmani Rajput, Manvendra Kumar, A. C. Pandey, at 23rd International Conference of International Academy of Physical Sciences, (CONIAPS-XXIII), 16-18 November 2018, NAST, Kathmandu, Nepal.
2. Poster presentation of the facility, "High Fluence Ion Beam Facility: A User Facility, **Vikas Baranwal**, Avinash C Pandey, at Indo-French Seminar on Radiation Damage in nuclear materials, Amity University, Noida, 18th-20th February 2019.

Main features

a) ECR source (Supernanogan)

1. Large area scanning: The beam can be raster scan for the large target area of 30 mmx 30 mm (± 15 mm x ± 15 mm)
2. High flux and high current: Because of high current from the ion source high flux of ions can be implanted in very short time period.
3. Switchability: The switching time between metal ions and gaseous ions is ~2-3 hours.
4. Range of ions: We can produce the metal ions by heating and sputtering techniques depending on element's melting point. Elements with higher melting points can be produced by using sputtering methods.

Below table indicates typical intensities for selected charge states. Beam intensity for various charge states given in μA .

Ion	Charge state	Current (μA)
He	2+	600
C	4+	160
O	6+	160
Ar	8+	140
Xe	20+	12
Ta	20+	10
Bi	20+	3

b) Vacuum System:

The pumping system is the set of equipments that produce and manage the vacuum required to produce a beam with good characteristics such as intensity and profile.

This pumping system is composed of: *Primary pumping (Dry scroll pump)*, *Secondary pumping (Turbo molecular pump)*, *Vacuum measurement (Penning and Pirani gauges)* and *valves*.

The facility is divided in to four different areas, separated by 4 *gate valves*:

- **AREA 1 (Vacuum System 1.1):** From the ECR Supernanogan source to the exit of the dipole
- **AREA 2 (Vacuum System 1.2):** From the end of the dipole to the acceleration column.
- **AREA 3 (Vacuum System 2):** From the start of the acceleration column to the exit of the switching magnet.
- **AREA 4 (Vacuum System 3):** From the exit of the switching magnet to the exit of the diagnostic system 3.

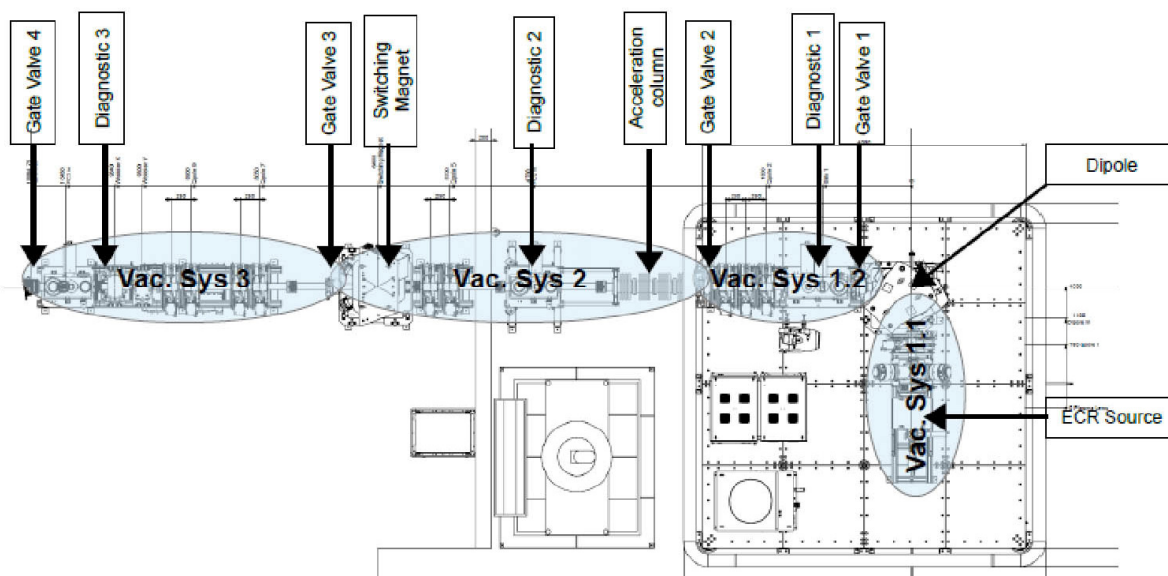

Block diagram of Vacuum system@ HFIBF

Operation:

Each area can be put in-vacuum or vented independently. Gate valves are managed by safety process, the pressure of each side of them must be equivalent to allow the opening of the aperture.

The primary pumping automatically start with the system power on. Secondary pumping starts when set points are activated.

The pumping system is separated in 3 sub-systems :

- 1st : Vacuum System 1.1 + Vacuum System 1.2
- 2nd : Vacuum System 2
- 3rd : Vacuum System 3

c) Beam Diagnostic:

Overview: There are three beam diagnostic systems installed in the high fluence ion beam (HFIB) facility. First one is installed immediately after the dipole, second one is installed after the acceleration tube and last one is installed just before the experimental chamber. The beam diagnostic system consists of following components:

1. The faraday cup: monitoring the beam current
2. Beam profile monitor: Beam profile in x and y direction
3. Slits: To cut the beam size
4. Quadrupole and steerer control: Focusing and alignment of the ion beam with steering in horizontal as well as vertical direction.
5. Wobbling system: Scanning the beam in X and Y direction

The Faraday cup:

The Faraday Cup is a device for measuring charged particle beam currents and charges in real-time. The measurement electrode is electrically insulated inside the cup housing and has to be connected to an electrical vacuum feedthrough by a Kapton insulated wire. The cup housing itself can also be mounted onto an electrically insulating holder in case the current on the housing is supposed to be recorded. Furthermore, the cup setup includes a suppressor electrode to compensate secondary electron emission from the cup surfaces. The cup is made exclusively from materials suitable for ultra-high vacuum conditions down to 1×10^{-10} mbar.

Here, the equipment is designed to monitor the intensity of the ion beam (in terms of current) with a maximum power of 60 Watts.

Before entering the copper block, the beam is going through a grounded disk and a biasable disk. The biased disk is for the secondary electron suppression. This can be used with a DC voltage power supply depending of the feature of the measured beam.

The copper block is equipped with two permanent magnets which create a magnetic field that acts as secondary electron suppressor. This is sufficient in most of the measured beam. If needed the effect can be improved by applying a DC bias voltage on the biased disk.

The linear motion is sealed using a stainless steel high vacuum bellow.

Only metal gaskets on CF 100 flanges are used for an optimum vacuum.

The Faraday cup and its actuator are fully removable for a simple maintenance and parts replacement.

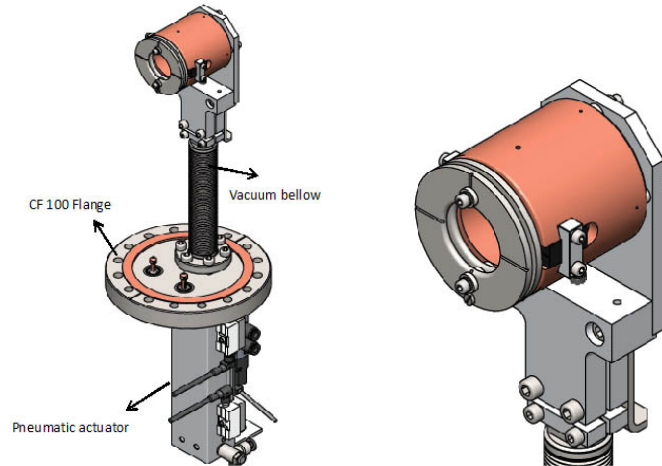

Description of Faraday cup

Beam profile monitor:

This equipment is designed to acquire the beam profile of a 500 watts ion beam maximum. Only metal gaskets on CF 100 flanges are used for an optimum vacuum. The wire is made of tungsten material and the profile range is 80 mm.

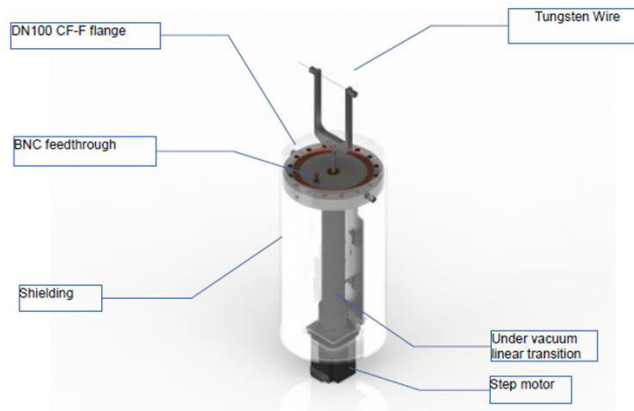

General description of beam profile monitor

Slits: Two double slits allows the reduction of the beam size and the measurement of the emittance. The slits are installed in the first beam diagnostic box after the dipole magnet.

Quadrupoles & steerer : This equipment is an optical equipment for ion beam. It includes a Quadrupole and a Steering magnet which are used to increase the transport efficiency of an ion beam. The quadrupole has 2 Alignment Fiducials Diam 6H7 accurately machined on the mounting plates. Use of spherically mounted retroreflector (SMR) with a laser tracking system allows accurate positioning and alignment of the Magnets. It is recommended that the quadrupoles be positioned within $\pm 1\text{mm}$ of their nominal positions along the beam axis, and within $\pm 0.25\text{mm}$ perpendicular to the beam axis.

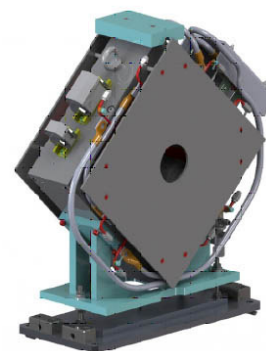

Technical details:

G	8T/m
GL	1,1T
Leff	140mm
Bore diameter	84 mm
Grade homogeneity dG/G	5.10^{-4}
Auxiliary dipole field	30G
Maximum Length	210mm
Dimension (L x W x H)	510 mm x 240 mm x 665 mm
Mass	313 kg

Wobbler System:

This equipment is a double AC magnetic dipole to raster scan the beam in X and Y direction in order to get a homogeneous irradiation on samples.

Technical description:

B/I	12.5 Gauss/Amp
Inductance	5.13 mH
Coil resistance	76 mΩ (DC)
Magnet gap	97 mm
Effective length	212 mm
Field flatness, transverse	± 20 mm off axis : 98% of B _{max}
Thermal protection	Resettable thermal switches, one per coil
Dimension (L x W x H)	310 mm x 340 mm x 383 mm
Mass	230 kg

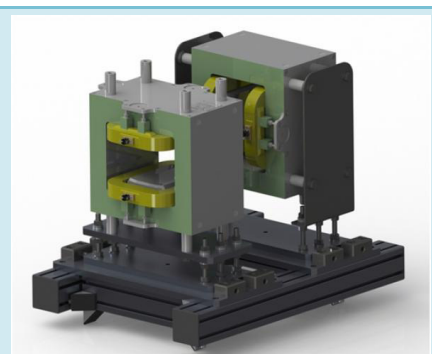

View of wobbler magnet

Images during experiment

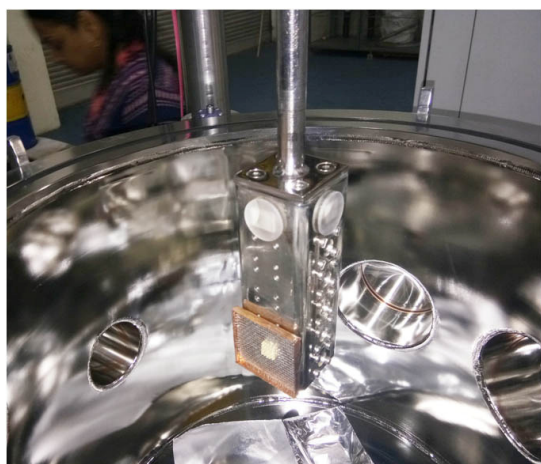

(a)

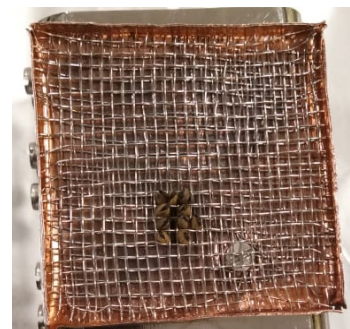

(b)

Sample ladder/holder mounted in the chamber: (a) Pre-implanted rice seeds (b) Seeds after implantation



Mounting the sample ladder/holder mounted in the chamber

CENTRE OF SCIENCE AND SOCIETY (Rural Technology and Development)

Introduction

With the approval of Academic Council vide Resolution No. 43/22dt.19.5.2015 and Executive Council Resolution No. 03/32 dt.2.6.15 and subsequent office Memorandum No. Comm. Sec./5243/2015 dt. 22.08.2015, the green signal was provided to start the M.Sc. IV semester CBCS based course in Rural Technology and Development under Institute of Inter Disciplinary Studies (IIDS) by the University of Allahabad with intake of 15 seats.

The University took lead to translate the PURA (Providing Urban Amminities in Rurarl Area) of Dr APJ Kalam and its execution by PM Modi's Sansad Adarsh Gram Yojana by adopting Ramapur Village of Bahadurpur block in Phulpur Tehsil of Allahabad District. In 1st phase chakzhaura Moja purely SC populated with high percentage of Females have been selected by the University for their Upliftment. Centre has again adopted five (05) Villages of Koraon Block, Allahabad as an initiative of Unnat Bharat Abhiyan and MHRD, New Delhi. Moreover the Centre has got the responsibility of Post project Evaluation study of Saansad Adarsh Gram Yojna of 104 of Uttar Pradesh.

In campus selection 18 interested candidates have been selected and well placed from two successful batch of 15 students each. It is also worth to mention that University of Allahabad has been identified as spoke partner of Design and Innovation Centre of IIT-BHU getting funds from MHRD. Further, the university approved the change of nomenclature from M.Sc. Rural Technology and Development to M.Sc. Design and Innovation in Rural Technology.

The centre is working towards the ideas for doubling India's Rural GDP, Facilitating affordable technology development appropriate to the rural context and Focusing on the sectors include Agriculture, Health, Finance, Education, Vocational Training, Business Processing technologies etc. for rural India. At Centre of Science and Society, we try and welcome innovative ways of agro based rural industries/Industrial technologies such as Vermicomposting, Biofertilizers, Candle making, Dairy activities, Mushroom cultivation, floriculture, paper bag making, medicinal plant cultivation, apiculture etc.

Vision

ORIGIN-To begin with a course dedicated towards overall development of rural technology, the Centre of Rural Technology and Development {M.Sc. (Four Semesters) Programme} under the Coordinator-ship/ Directorship (Honorarium basis) in Department of Botany, University of Allahabad, efforts will made to retrieve funds under **CSR** (Corporate- Social Responsibility) from Coal India, NTPC, IFFCO, and Private Industry viz., Kirloskar, Mahindra Tractors, Monsanto etc. In addition to this, the Ministry of Rural Technology and Ministry of Small and Medium Scale Industries, Govt. will also render support in establishing an independent centre of Rural Technology and Development which will incorporate advancement of technological and social aspect of rural development.

Objectives

- Assessment of rural area and people.
- Rural Entrepreneurships (self-employment through sericulture, lac farming, flower farming, mushroom culture, bee keeping, preparation of natural dyes, bio composting, E-waste management, Biofertilizers etc.).
- Safe and eco-friendly technologies promotion and their compatibility amongst villagers.
- Conservation and promotion of indigenous knowledge.
- Socio-nutritional-economic development of indigenous peoples through appropriate integrated technology and awareness.
- Generating awareness regarding government policies (monitoring and documentation).
- Rural planning and implementation of rural development projects.
- To develop skill in students to for aforementioned tasks.

Programmes of Study:

S. No.	Programme of Study	Duration	No. of Seats	Specialization(s)
1.	Ph.D.	As per UGC norms	06	Design and Innovation in Rural Technology
2.	M. Sc. Design and Innovation in Rural technology	2 years	15	Rural Entrepreneurship, IT in Rural Development, Commercial Production Technology Rural Health Management

Faculty Members and their area of Research:

S.No.	Name	Designation	Permanent/Guest Faculty/ Ad hoc/ Temporary	Area of Specialization
1.	Dr. Anupam Dikshit, <i>FNASc</i>	Coordinator	Director, faculty Recruitment Cell, Professor and Ex-Head, Botany Department, University of Allahabad	Rural Development, Microbiology, Plant Pathology, IPR, Biotechnology, Plant resource utilization, Biological Product for human as well as agricultural health
2.	Dr. Arpana Pandey	Assistant Professor	Permanent	Rural tech. and dev. Natural resource management, Production and post- harvest management, Rural health management, Information technology in rural development
3.	Dr. Rohit Kumar Mishra	Associate Professor	Permanent	Rural technologies for sustainable development; Herbal Antimicrobials, Organic farming; Nanotoxicity, Heritage agricultural; Bio-instrumentation; Microbes & its uses, Environmental microbiology
4.	Dr. Shashi Kant Shukla	Assistant Professor	Permanent	Commercial technologies, Basic Botany, Agriculture, Information technology, Rural development and its management

Details of Students, Year wise and Reservation wise (2018-2019):

Course	Gen			OBC			SC			ST			TOTAL		
	Male	Female	Total	Male	Female	Total	Male	Female	Total	Male	Female	Total	Male	Female	Total
Ph.D.	02	00	02	00	01	01	00	00	00	0	0	0	0	0	03
PG	10	06	16	06	02	08	04	00	04	0	0	0	0	0	28
Total	12	06	18	06	03	09	04	00	04	0	0	0	0	0	31

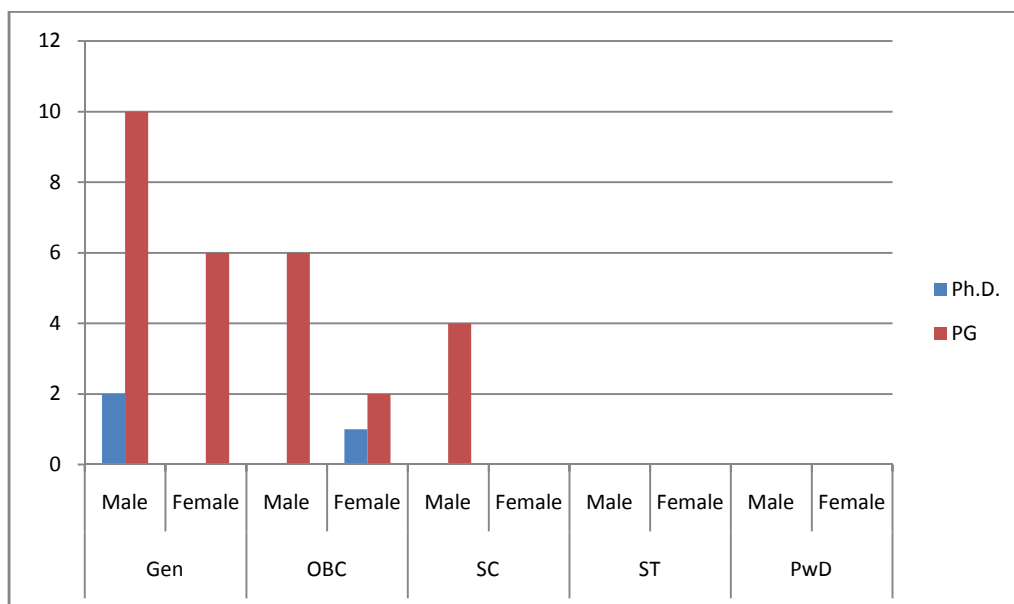

Student Enrollment for the Department

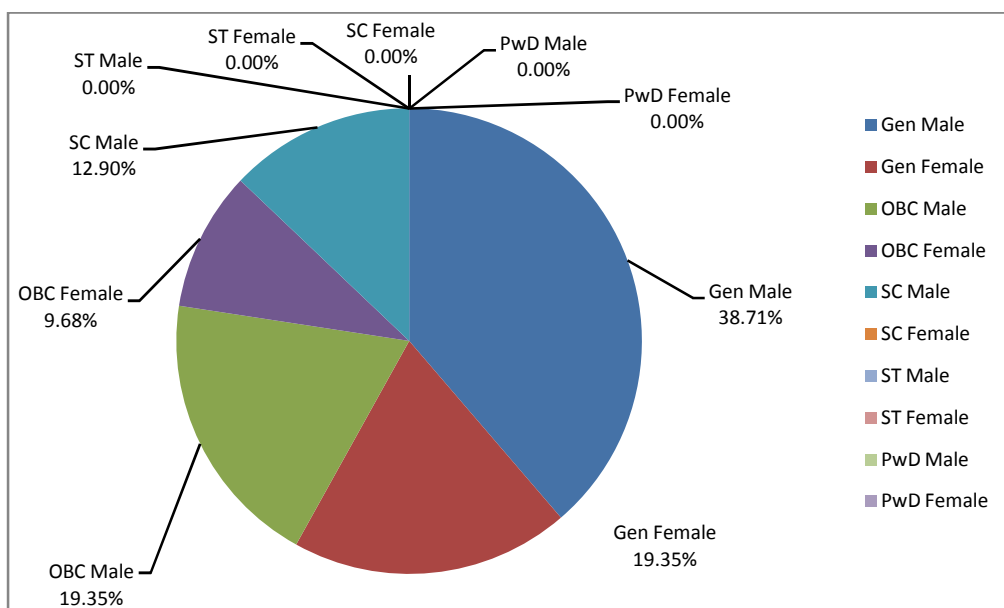

Gender wise distribution of Students

Seminars/Workshops/Conferences conducted by the Department:

S.No.	Name of the Seminar/workshop/conference	National / International	Duration and dates	Funding/sponsor Agency(y/ies)	No. of Participants
1.	Swadeshi Ki Avdharna :Gandhi hi vikalp hai	National	01 day 25.02.2019	UoA and Swadeshi Jagran Manch	200

Funding received during the period (amount/purpose/agency):

S. No.	Agency	Purpose	Amount
1.	Allahabad University annual grants	Lab Grant	1.5 Lakhs

Other publications

S. No.	Title	Type	Author(s)	Publication	ISBN
1.	Rural Development: Traditional to Modern India.	Text Book	Kumar R, Shukla SK and Dikshit A	Studera Press, New Delhi. (National)	978-93-85883-62-0.

Awards/ Achievements:

Participation of M. Sc. students of Centre of Science and Society in 7th International Seminar on “Wallop of Globalization in Engg-Medi-Sci-Pharm-Tech Research” at Swami Vivekananda University, Sagar, M.P. from 27-28 February, 2019

S.No	Name	Topic	Category	Remarks
1.	Dr. Rohit Kumar Mishra	Excellent Teacher Award-2018 by Chairman, Pvt. Regulatory Board & Vice Chancellor, Barkatullah University, Bhopal	Teacher	Excellent Teacher of the Year
2.	Dr. Rohit Kumar Mishra	American Chemical Society (ACS) grant for India International Local Chapter Local Section	Teacher	American Chemical Society
3.	Anjali Yadav	Menstrual health and management with special reference of low cost personal hygiene product	Research Scholar	2 nd Best Poster Presentation award
4.	Astha Srivastava	Yagya: health and environment	M. Sc. Student	
5.	Chanchal	Concept of an ideal village	M. Sc. Student	

S.No	Name	Topic	Category	Remarks
6.	Saraswati Yadav	Use of waste products to make handmade paper	M. Sc. Student	3 rd Best Poster Presentation award

Placement of students:

S.No.	Name of Student	Class	Hiring Firm
1.	Anvesha Ranjan	M.Sc. IV SEM	Csr And Fund Raising Section-Shehgal Foundation, Gurugram, India
2.	Nirbhay Singh	M.Sc. IV SEM	Project Officer-Dry Seeded Rice, Agriculture Devision- Corteva Agriscience, Lucknow, India
3.	Gaurav Srivastava	M.Sc. IV SEM	Sales Executive, Rural Marketing Division Dayal Industries Pvt. Ltd., Haridwar, India

Activities of Centre of Science and Society, IIDS, UoA, in chronological order

1. Plantation in adopted village Ramapur, Block-Bahadurpur, Tahsil-Phulpur, District-Prayagraj-211002



Coordinator, Prof. Anupam Dikshit, Retd. DRDO Scientist, Dr. Md. Arif, Gram Pradhan-Mr. Rammurthy Yadav, Faculty member and students participating in plantation at adopted village on 14.08.2018

2. On September 08, 2018, Coordinator, Faculty Member and students of Centre of Science and Society, IIDS, University of Allahabad visited adopted villages under Unnat Bharat Abhiyan; Kaithwal, Kihuni Kala, Kihuni Khurd and Bahraicha of Block Koraon, District-Prayagraj



3. Participation of Centre of Science and Society in Paryavaran Kumbh at Kashi Vidyapeeth, Varanasi-December, 01-02, 2018.
4. An exposure of Mahatma Gandhi Gramodaya Vishwavidyalay and Deen Dayal Upadhyay Research Institute Chitrakoot, M. P. in 88th annual session of NASI on Science, Technology and Ecosystem for Sustainable Rural Development; December 04-06, 2018



5. Collaborative International Conference with Rural Innovation Centre, Centre of Science and Society, University of Allahabad and SVN University SAGAR during 27-28 Feb. 2019



6. National seminar on Swadeshi ki Awdharna: Gandhi hi Vikalp at D.D. Pant Auditorium, Botany Department, UoA on 25.02.2018



Hon'ble Vice Chancellor presenting bouquet to Shri Harivansh Ji, Deputy Chairman, Raja Sabha

CENTRE OF BEHAVIORAL AND COGNITIVE SCIENCES

Introduction:

The Centre of Behavioural and Cognitive Sciences was established under the UGC Potential for Excellence Scheme in 2002 and was formally inaugurated by Hon'ble Union Minister Prof. MuraliManohar Joshi in Feb 2003.

Highlights

The Centre aims to achieve excellence in education and research meeting new developments and challenges. The Centre endeavours for advancement of scientific knowledge through basic and applied research and conducts outreach programmes for larger human welfare.

The Centre has been offering Masters in Cognitive Science since 2002 and PhD in Cognitive science since 2005.

The Centre has brought recognition for the discipline of Cognitive Science in India through research, National and International collaborations, International conferences and GIAN courses.

Student placements in PhD programs and post-doctoral fellowships at prestigious institutes in India including NBRC, IITs, IIITs and Universities outside India

Multiple research labs with state of the art equipment with the most recent development of the National neuroimaging facility, first of its kind in a University set up in India.

Outreach program (workshops, memory camp for elderly and consultancy services)

Thrust Areas:

- Attention and Consciousness
- Self, Agency, and Intentions
- Emotion and Attention
- Meditation
- Cognitive Development
- Cognitive Disorders
- Bilingualism and Cognitive control
- Decision Making
- Social and Cultural Cognition
- Action Planning and Control

Programmes of Study:

S. No.	Programme of Study	Duration	No. of Seats	Specialization(s)
1.	Ph.D.	5 years(includes course work)	Variable	Cognitive Science
2.	M. A./M. Sc.	2 Years	23	Cognitive Science

Faculty members and their Area of Research:

S.No.	Name of Faculty	Designation	Area of Specialization
1.	Dr. Bhoomika R. Kar	Professor & Head (joined as Head on March 12/06/18)	Developmental cognitive neuroscience
2.	Dr. Narayanan Srinivasan	Professor	Attention, Emotions, Decision Making and Consciousness
3.	Dr. Niharika Singh	Assistant Professor	Psycholinguistics
4.	Dr. Supriya Ray	Assistant Professor	Neurophysiology of Actions

Support Staff:

S.No.	Name	Gender	Category	Designation	Work assigned
1.	Puneet Kumar	Male	Gen	Senior Technical Assistant	Work of Administrative Officer, Exam, Purchase, Admission etc.
2.	Shabeeh Abbas	Male	Gen	Sr. Accounts Assistant	Accounts related work, maintenance of Generator etc.
3.	Praveen Singh	Male	Gen	Sr. Library Assistant	Library and academic related work

S.No.	Name	Gender	Category	Designation	Work assigned
4.	Nanku Ram	Male	OBC	Helper	Helper
5.	Surendra Yadav	Male	OBC	Helper	Gardener cum Helper
6.	Ramu Pal	Male	OBC	Helper	Helper in Library
7.	SohanLal	Male	SC	Safaiwala	Safaiwala

Details of Students, Year wise and Reservation wise (2018-2019):

Course	Gen			OBC			SC			ST			PwD			TOTAL		
	Male	Female	Total	Male	Female	Total	Male	Female	Total	Male	Female	Total	Male	Female	Total	Male	Female	Total
Ph.D.	5	7	12	3	1	4	-	1	1	-	-	-	-	-	-	7	10	17
PG	9	8	17	4	1	5	3	2	5	-	-	-	-	-	-	16	11	27
Total	14	15	29	7	2	9	3	3	6	-	-	-	-	-	-	23	21	44

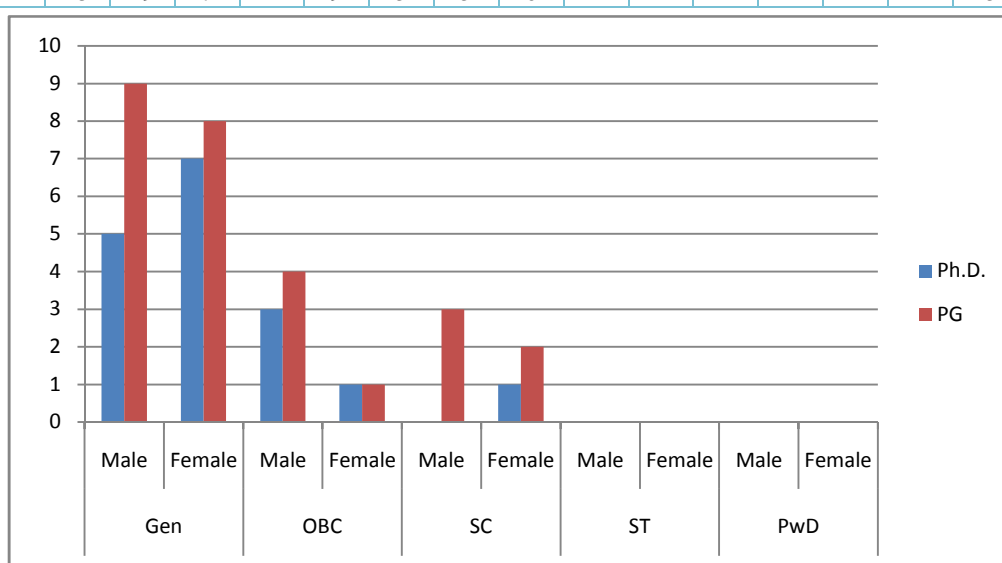

Student Enrollment for the Department

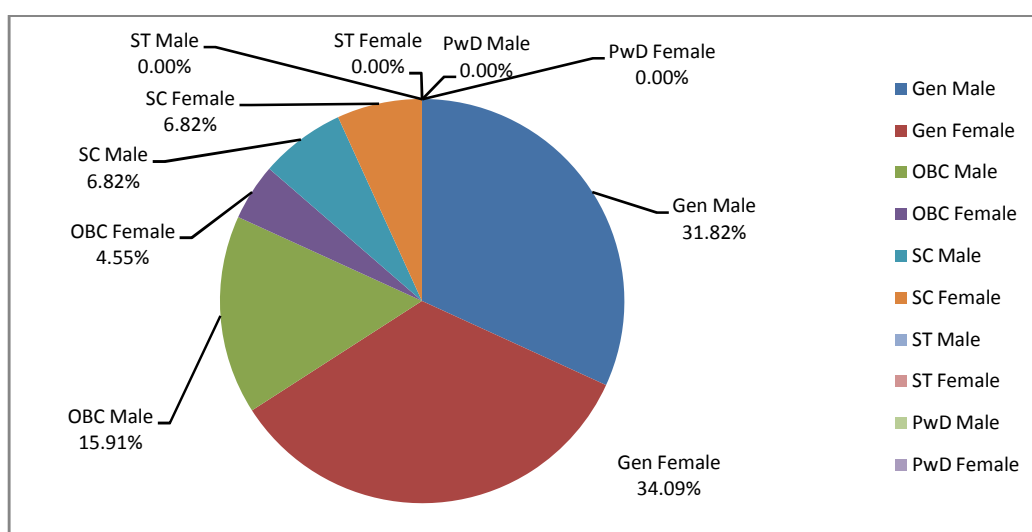

Gender wise distribution of Students

Training/orientation/refresher courses/special lectures conducted by the Centre:

S. No.	Name of the course	Duration and dates	Funding/ sponsor	Speakers
1.	GIAN 2018 course on “Developmental Cognitive Neuroscience”	December 10-22, 2018 Around 52 hrs.	MHRD Govt. of India	Prof. ChandanVaidya, Chair, Dept. of Psychology, Georgetown University, USA and Prof. Bhoomika R. Kar, CBCS, AU
2.	GAIN 2019 course on “Advances in Learning and Decision Making”	February 11-22, 2019 Around 48 hrs.	MHRD Govt. of India	Prof. Mehdi Khamassi, CNRS, ISIR, France and Prof. Narayanan Srinivasan, CBCS, AU
3.	Workshop on DALI to train teachers and professionals for dyslexia assessment	September 2018	CBCS, AU	Dr. GeetOberoi, ORKIDS, New Delhi and Prof. Bhoomika R. Kar

Awards/Honours/Fellowship received:

S.No.	Name of Faculty Member/Student who received award	Name of the award	Organization conferring award
1.	Prof. Narayanan Srinivasan	Fellow	National Academy of Psychology (India)
2.	IshanSinghal	Travel award	University of Hannover

Funding received during the period (amount/purpose/agency) to the

S. No.	Agency	Purpose	Amount
1.	DST	Research project	Rs. 2. 86 lakhs
2.	UGC (CPEPA)	Remaining grant under the CPEPA scheme	1.46 Crore
3.	DST	Neuro Imaging Facility	1.35 Crore
4.	DST FIST grant	Infrastructure and training	1.30 Crore

Proposed Courses

S. No.	Name of Programme	Nature	Duration	Proposed or In process	Intake	Remarks
1.	M.Sc. in Human Computer Interaction	Degree	2 years	Proposed and approved by the Academic Council, AU	15	Would be offered once the Centre has adequate number of faculty
2.	M.Sc. in Clinical and Cognitive neuropsychology	Degree	2 years	To be proposed	15	Clinical research, assessment and rehabilitation of individuals with neurological/ neurosurgical and neuropsychiatric disorders.

Proposed Projects/SAP Grants etc.

S. No.	Type of Project / grant	Title/Name	Duration	Proposed amount	Remarks
1.	Research	Meditation, Mind wandering, Cognition and Affect A comprehensive study of multiple processes	3 years	6589000 /-	Submitted to DST
2.	Research	Assessing the feasibility of large-sample, multi-time-scale measurement of situated human cognition	3 years	45432000 /-	Submitted to DST

Outreach activities:

S.N.	Name of Faculty Member/ Student/ Researcher	Title of the paper presented	Title of Conference/Seminar etc	Duration of the conference/assignment	Organized by
1.	Prof. Bhoomika R. Kar	Introduction to dyslexia and DALI	Workshop on Dyslexia assessment for languages of India for teachers and professionals	September 7-8, 2018	CBCS in collaboration with NBRC, Manesar

	Prof. Bhoomika R. Kar	Bilingualism, Proficiency, and temporal dynamics of proactive control (Keynote)	International symposium on Bilingualism and Cognition	October 1-3, 2018	BITS, Pilani, GOA campus
	Prof. Bhoomika R. Kar	Neuro-cognitive mechanisms of affect dependent cognitive control: Implications for studies on emotion regulation (Keynote)	International Conference of Indian Academy of Health Psychology	November 14-15, 2018	MSG CollegeNasik
	Prof. Bhoomika R. Kar	Experimental methods in Cognitive Science (Invited talk)	Capacity building program	November 17, 2018	Lucknow University
2.	Prof. Narayanan Srinivasan	Scope of Attention (Invited Talk)	Workshop on Mind, Brains & technology	March 30, 2019	IIT Delhi
	Prof. Narayanan Srinivasan	Intentional and control effects on sense of agency and perception (Keynote)	Symposium on Self: As a Pivotal Concept Across Philosophy, Psychology, & Neuroscience	February 25, 2019	IIT Kanpur
	Prof. Narayanan Srinivasan	Attention and Awareness (Invited Talk)	National Science Day Symposium	February 26, 2019	IIT Kanpur
	Prof. Narayanan Srinivasan	Effect of meditation on perception and attention (Keynote)	Dialogue Between Ancient Indian and Modern Science Contemporary Studies On Meditation	November 2-3, 2018	Sera Jey Monastic University, Bylakuppe
	Prof. Narayanan Srinivasan	Concepts in Indian philosophy and scientific study of mind (Invited Talk)	Mind, Meditation and Innovation Conference	September 3-5, 2018	Copenhagen, Denmark
	Prof. Narayanan Srinivasan	Effects of Meditation (Invited Talk)	The State of SEL assessment, Second Futures' Workshop	July 19-21, 2018	UNESCO's MGIEPSP, Paris, France
	Prof. Narayanan Srinivasan	Attention, emotions, and awareness (Invited Talk)	IBRO-APRC School on Cognitive Neuroscience: The 5th Bangalore Cognition Workshop	June 22, 2018	Indian Institute of ScienceBengaluru
	Prof. Narayanan Srinivasan	Emotion perception in the context of temporal attention	Symposium on Relations between Emotion, Attention, Psychopathology and the Brain, Consortium on European Researchers on Emotion Conference	April 4-5, 2018	University of Glasgow, Scotland, UK
	Prof. Narayanan Srinivasan	Interactions between emotion and attention (Invited Talk)	Department of Psychology	April 3, 2018	University of Dundee, Scotland, UK
3.	Dr. Supriya Ray	Saccadic Chronostasis During Sequential Eye Movements	The Scandinavian Workshop on Applied Eye Tracking	AUGUST 23 – 24, 2018	Copenhagen Business School Denmark
	Dr. Supriya Ray	The Interplay Between Perception And Action In The Oculomotor Domain	Annual Meeting of The Indian Eye Research Group And Arvo (India)	JULY 28 – 29, 2018	L V Prasad Eye Institute Hyderabad
	Dr. Supriya Ray	A Neurally Viable Model Of Sequential Eye-Movements	International Workshop On Computation And Networking For Internet Of Things And Beyond, Icdcn	JANUARY 4, 2018	Iit- Bhu, Varanasi



Inauguration of National Neuroimaging Facility at CBCS



Global Initiative of Academic Networks (GIAN): Course on Developmental Cognitive Neuroscience - 10th -22nd December, 2018 and Course on Advances in Learning and Decision on 11-22 February 2019



Allahabad Regional Brain Bee Competition, 2019: Memory Camp for the elderly for detailed cognitive profiling and memory assessment

INSTITUTE OF PROFESSIONAL STUDIES

CENTRE OF FOOD TECHNOLOGY

Introduction:

The creation of Centre of Food Technology was done with a vision to encompass food science, food production, food processing, food technology, food safety, food management, entrepreneurship development, food processing and rural development; agriculture and industry linkage through food processing, quality assurance for safe food, research and development on functional foods. M.Sc. Nutritional Sciences was started in year 2000. M.Sc. Food Technology programme was initiated in July 2002 as per the guidelines of UGC and ICAR. This was facilitated by a grant from Ministry of Food processing Industries, Govt. of India under its "Manpower Development Programme".

The Centre is currently offering M.Sc. and Ph.D. degree programmes. In 2015, UGC has also sanctioned about Rs. 90 lakh for offering B.Voc. Food Processing and Technology in linkage with Sector Skill Council which has been started from the year 2015. The Centre has been sanctioned nearly Rs. 1 crore by MoFPI for setting up a commercial quality control laboratory to serve the industry in surrounding areas by providing testing services for quality assurance and food safety. The Centre has established NABL accredited Food Analysis and Research Laboratory for commercial testing of food and water sample which is also given status of Nodal Lab by FSSAI in year 2015. The Centre has been granted externally funded projects from time to time through various nodal organizations such as UGC, DST, APEDA, UPCAR etc.

Thrust Areas:

- Providing education and training for creating strong human resource capacities for the food processing industry and academic institutions in the country.
- Upgrading the skills of academicians, research students and entrepreneurs in field of food science and nutrition.
- Basic, applied and adoptive research and development in post harvest processing, preservation and value addition of food groups.
- Identification of dietary and nutrition problems prevalent among different segments of the population.
- Analytical services to food industries and research institutes for testing the food and other organic samples.

Programme of Study

S.No.	Programme of Study	Duration	No. of Seats	Specialization(s)
1.	Ph.D.	5years (includes course work of 24credits)	23 students presently enrolled	Food Technology and Nutritional Sciences.
2.	M.Sc. Food Technology	2 Years	79	Food Technology
3.	M.Sc. Nutritional Sciences	2 Years	51	Nutritional Sciences
4.	B.Voc Food Processing & Technology	3 Years	65	Food processing and Technology

Faculty members and their Area of Research:

S. No.	Name of Faculty	Designation	Area of Specialization
1.	Dr. Devinder Kaur	Assistant Professor	Fruits and Vegetable Processing ,Cereal Sciences, Degradation and drying Kinetics
2.	Dr. Neelam Yadav	Professor& Coordinator	Micronutrients, Processing and Nutritive Value of Food, Grain Sciences
3.	Dr. Pinki Saini	Assistant Professor	Food Microbiology, Antioxidants, Biomass Utilization

Details of Students, Programme wise and Reservation wise 2018-2019):

Course	Gen			OBC			SC			ST			PwD			TOTAL		
	Male	Female	Total	Male	Female	Total	Male	Female	Total	Male	Female	Total	Male	Female	Total	Male	Female	Total
Ph.D.	0	0	0	0	0	0	0	0	0	0	0	0	0	0	0	0	0	0
PG	24	40	64	18	32	50	6	8	14	0	2	2	0	0	0	48	82	130
UG	17	22	39	11	10	21	2	3	5	0	0	0	0	0	0	30	35	65
Total	41	62	103	29	42	71	8	11	19	0	2	2	0	0	0	78	117	195

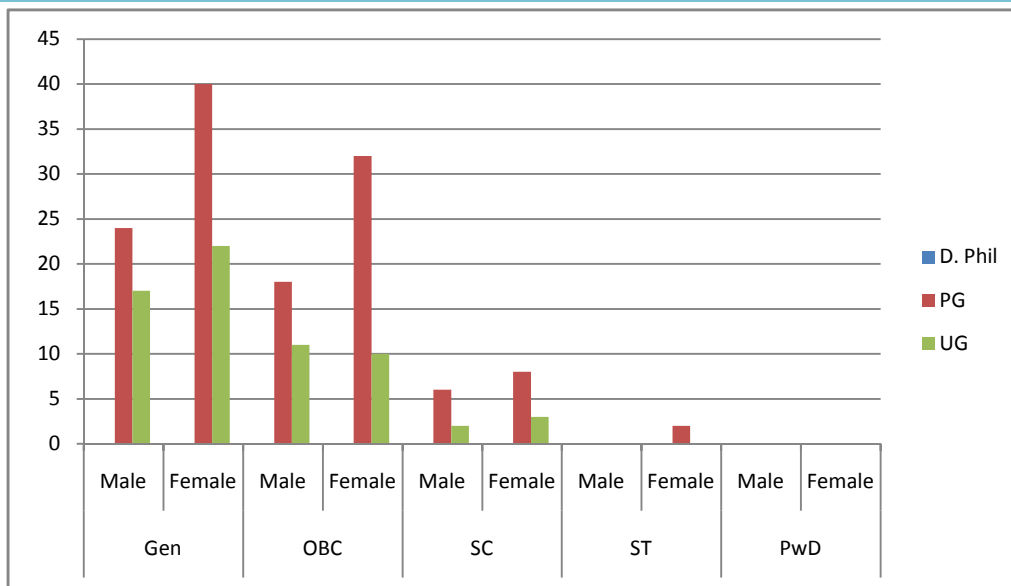

Student Enrollment for the Department

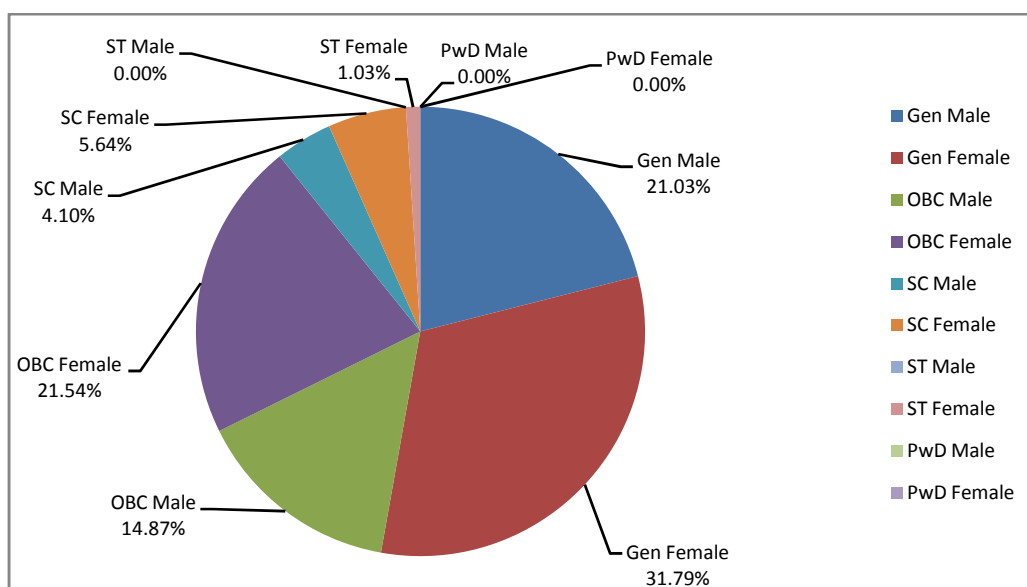

Gender wise distribution of Students

Seminar/Workshops/Conferences conducted by the Department/Centre:

S. No.	Name of the Seminar/ Workshop/Conference	National/ International	Duration and Dates	Funding/ Sponsor Agenc(y/ies)	No. of Participants	No of Paper Presented
1.	National Seminar on "Minimizing Disease Burden of Women through Awareness Programmes MDBWTAP-2019"	National	16 th Feb 2019	-	200	12-Oral 50-Poster

Training/orientation/refresher courses/special lectures conducted by the Department/ Centre:

S. No.	Name of the course	Duration and dates	Speakers
1.	Summer Training of 12 days of M.Sc. Food Technology & M.Sc. Nutritional Sciences students	15 Days (16 th to 30 th May, 2018)	<ul style="list-style-type: none"> • Dr OP Chauhan, Scientist E, DFRL, Mysore • Prof. Suresh Sharma, Dept of Statistics, Punjab University, Chandigarh • Dr. Vijay Mallik, Bureau of Indian Standards, New Delhi • Dr. TK Bansal, Lucknow, Sr. Lecturer IHM, Lucknow • Dr Shikha Khanna, Chief Dietician, RML Hospital, New Delhi. • Dr Gurdeep Kaur, Assistant Dietician, AIIMS New Delhi • Prof. C.P. Mishra, Institute of Medical Sciences, BHU, Varanasi
2.	Application of "Spectroscopy and Chromatography" in Food Analysis	13 th -14 th Sep, 2018	Prof. Baliram, Deptt. Of Chemistry, BHU, Varanasi
3.	Product Development Process & Innovation Strategy	15 th & 16 th Nov, 2018	Dr. Mudassir Malik, Dept. of Bioengineering, Integral University, Lucknow.
4.	Application of computerization and IT in Food Technology	22 nd to 24 th Jan, 2019	Dr. Mudassir Malik, Dept. of Bioengineering, Integral University, Lucknow
5.	Bakery Technology	28 th Jan – 1 st Feb, 2019	Mr. Shorya Kapoor, Director, ASSOCOM India Pvt. Ltd., New Delhi
6.	Processing of Meat and Meat Products" for M.Sc. Food Technology and B.Voc. Food Processing & Technology students	26 th – 29 th March, 2019	Prof B.D. Sharma, Former Head and Principal. Scientist IVRI, Izzatnagar, Bareilly
7.	An awareness programme on "Inhibition of adulterated Food Consumption this holi"	7 th March, 2019	Food Safety & Drug Administration, Prayagraj and Centre of Food Technology, University of Allahabad

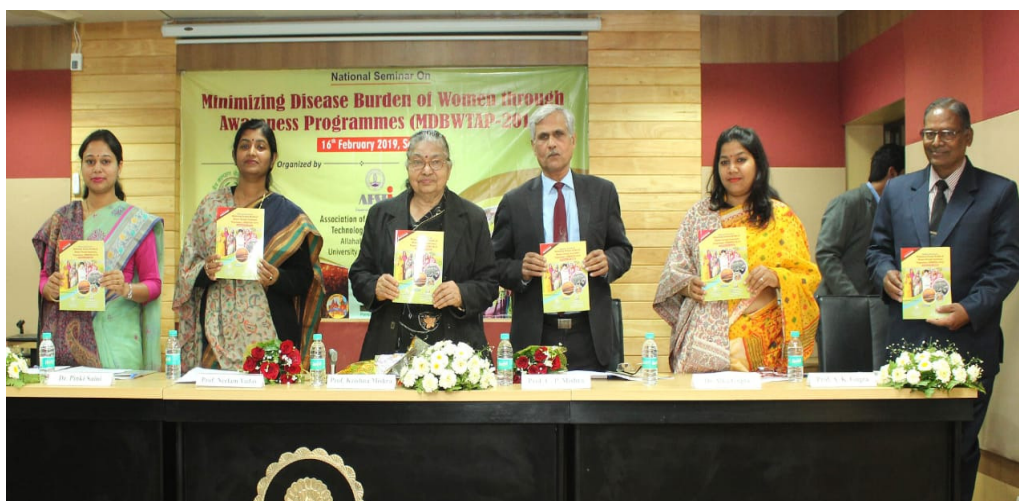

National Seminar on “Minimizing Disease Burden of Women through Awareness Programmes MDBWTAP-2019” organised on 19th February, 2019



awareness programme on “Inhibition of adulterated Food Consumption this holi” on 7th March 2019



Workshop on Bakery Technology organized by ASSOCOM India Pvt. Ltd., New Delhi on 28th January to 1st February 2019

Funding received during the period (amount/purpose/agency) to the Department/Centre

S. No.	Agency	Purpose	Amount
1.	Lab Grant (Allahabad University 12 th plan lab grant)	Consumables	50,000/-

Academic Organizations (headquartered in the department/Centre):

S.No.	Name	Nature	Objectives
1.	Association of Food Scientists and Technologist (India) AFST(I) Allahabad Chapter	National	The AFST(I) is one of the largest professional and educational organization with around 3500 members, food scientists and technologists across the globe. CFT has open AFST(I) Allahabad Chapter in Jan 2017 and it conducted National Nutrition Week on 7 th September 2018 supporting the Eat Right initiative of FSSAI, to promote safe and healthy food, through voluntarily reducing salt, sugar and saturated fat in packaged food products. The theme of the event was the tag line of the campaign “Aaj se thoda kam”.

Outreach activities:

S. No	Name of Faculty Member/ Student/ Researcher	Title of Conference/ Seminar etc	Duration of the conference/ assignment	Organized by
1.	Radha Kushwaha	International conference on Agriculture allied and Applied sciences	28-29 April 2018	Biologix Research and innovation Centre Pvt. Ltd.(BRICPL)
2.	Vinita Puranik	Recent trends in Agriculture Biodiversity and Social Sustainability	30th Sept- 1st Oct, 2018	BSI, Allahabad
3.	Devinder Kaur	International Symposium on Recent Trends in Agriculture, Biodiversity and Social Sustainability (ABSS 2018)	Sep. 30 & Oct. 01, 2018	Blue Planet Society, Allahabad - India
4.	Swati Agarwal	-do-	Sep. 30 & Oct. 01, 2018	-do-
5.	Monika Singh	-do-	Sep. 30 & Oct. 01, 2018	-do-
6.	Radha Kushwaha	-do-	Sep. 30 & Oct. 01, 2018	-do-
7.	Pinki Saini	-do-	Sep. 30 & Oct. 01, 2018	-do-
8.	Devinder Kaur	-do-	Sep. 30 & Oct. 01, 2018	-do-
9.	Rashmi Srivastava	Workshop on “Statistical Design and Analysis of Experiments”	27-8-2018 to 31-8-1018	Department of Food, Nutrition and Public health, Ethelind College of Home Science, Sam Higginbotom University of Agriculture, Technology & Sciences
10.	Vandana Verma	Workshop on “Statistical Design and Analysis of Experiments”	27-8-2018 to 31-8-1018	-do-
11.	Zoomi Singh	-do-	27-8-2018 to 31-8-1018	-do-
12.	Urvashi Srivastava	-do-	27-8-2018 to 31-8-1018	-do-
13.	Sehar Fatima	-do-	27-8-2018 to 31-8-1018	-do-
14.	Devinder Kaur	Seminar on “Recent Trends in Agriculture Biodiversity and Social Sustainability (ABSS 2018)”	30-9-2019 to 1-10-2018	Blue Plant Society, Allahabad, U.P., India, Botanical Survey of India, CRC, Allahabad, Govt. PG College, Saidabad-Allahabad, International Academy of Science and Research, Kolkata, W.B., India, Confederation of Indian Universities, New Delhi
15.	Pinki Saini	Seminar on “Recent Trends in Agriculture Biodiversity and Social Sustainability (ABSS 2018)”	30-9-2019 to 1-10-2018	-do-
16.	Vinita Puranik	-do-	30-9-2019 to 1-10-2018	-do-
17.	Rashmi Srivastava	-do-	30-9-2019 to 1-10-2018	-do-
18.	Vandana Verma	-do-	30-9-2019 to 1-10-2018	-do-
19.	Monika Singh	-do-	30-9-2019 to 1-10-2018	-do-
20.	Zoomi Singh	2 nd International Conference on “Advances in Agricultural, Biological and Applied Sciences for Sustainable Future (ABAS-2018)	20 th to 22 nd Oct, 2018	The Agricultural Technology Development Society (ATDS), Ghaziabad, Swami Vevakanand Subharti University, Meerut, and Faculty of Agriculture, Cairo University, Egypt at Sardar Patel Auditorium, Swami Vevakanand Subharti University, Meerut

Invited Lectures

S.No.	Name of the course	Duration and dates	Speakers
1.	Biodegradable Packaging Materials: Need and Scope” in National seminar on “Present Scenario of Environmental Challenges and Issues”	16 th December 2018 at CMP College, Allahabad.	Dr Pinki Saini
2.	“Valorization of Fruits and Vegetable Waste” National Seminar on “Present Scenario of Environmental Challenges & Issues	16 th December 2018 at CMP College, Allahabad.	Dr Devinder Kaur
3.	Utilization of Industrial Waste for Food Application” National Seminar on “Present Scenario of Environmental Challenges & Issues	16 th December 2018 at CMP College, Allahabad.	Dr Vinita Puranik

Awards/Achievements:

S.No.	Award	Date	Awardee
1.	Bioved Fellowship Award-2019	17 th Feb 2019	Prof. Neelam Yadav
2.	Gold Medal (Award of Merit) in M.Sc. Nutritional Sciences, 2017	15 th August 2018	Ms Sahar Fatima

CENTRE OF COMPUTER EDUCATION

Introduction:

The Centre of Computer Education established under IPS in December 2000, is offering BCA, MCA degrees, PGDCA and Ph.D. programmes in computer application. In 2006 the Centre was granted full accreditation by NIELIT (an autonomous body of Dept. Of Information Technology, Ministry of Communication & Information Technology, Govt of India, New Delhi) for a period of 6 years to conduct NIELIT 'O' level computer courses and it is continuing.

The Centre has a number of computer laboratories in a networked environment. It also lays equal emphasis on hardware training and therefore it has established digital electronics laboratory, embedded system design lab, digital communication lab and also robotics lab.

The institute regularly provides its laboratory for the conduct of on-line tests by various agencies for campus recruitment of the students by various departments of the university. Further, the institute helps in the conduct of computer practical examinations of various other courses of the university as well as 'O' level examination of NIELIT. The centre has adequate number of lecture rooms with all modern multimedia teaching aids.

The centre has a library where text books, reference books, magazines and journals are available to the students. In BCA and MCA courses the centre provides a text book each of all the courses in different semesters through the book bank facility.

Thrust Areas:

- A. To Set up Intelligent Process Control Laboratory
- B. To set up an Advanced Network Laboratory to provide proper Hands-on Training
- C. To run various IT related Entrepreneurship Development Programme/Skill Development Programme envisaged by the Central Government
- D. Wireless and Ad-Hoc Networks, Sensor networks
- E. Data Mining
- F. Computer Vision, image and video processing
- G. Secure computing
- H. Advances in e-Learning
- I. Design of Body area networks

Programmes of Study:

S. No.	Programme of Study	Duration	No. of Seats	Specialization(s)
1.	Ph.D.	5 years (includes course work)	04	
2.	M.C.A.	3 Years	40	Elective papers are there in the final two semesters
3.	B. C.A.	3 Years	80	Elective papers are there in the final two semesters
4.	Diploma Courses (PGDCA)	1 Year	60	

Faculty members and their Area of Research:

The centre doesn't have any sanctioned teaching/non-teaching positions till date. All the courses are being run in the self-financing mode. The teachers are appointed as Resource Person on contractual basis at a fixed salary and in the similar manner non-teaching positions (technical/ non-technical) are also filled-up.

The Course Coordinator of the Center is Professor of Computer Science.

Details of Students, Programme wise and Reservation wise:

Course	Gen			OBC			SC			ST			TOTAL		
	Male	Female	Total	Male	Female	Total	Male	Female	Total	Male	Female	Total	Male	Female	Total
Ph.D.	1	2	3	1	0	1	0	0	0	0	0	0	2	2	4
PG (MCA)	33	12	45	17	13	30	2	2	4	0	0	0	52	27	79
UG (BCA)	67	13	80	48	9	57	6	2	8	1	0	1	122	24	146
PGDCA	4	1	5	9	2	11	2	2	4	0	0	0	15	5	20
Total	105	28	133	75	24	99	10	6	16	1	0	1	191	58	249

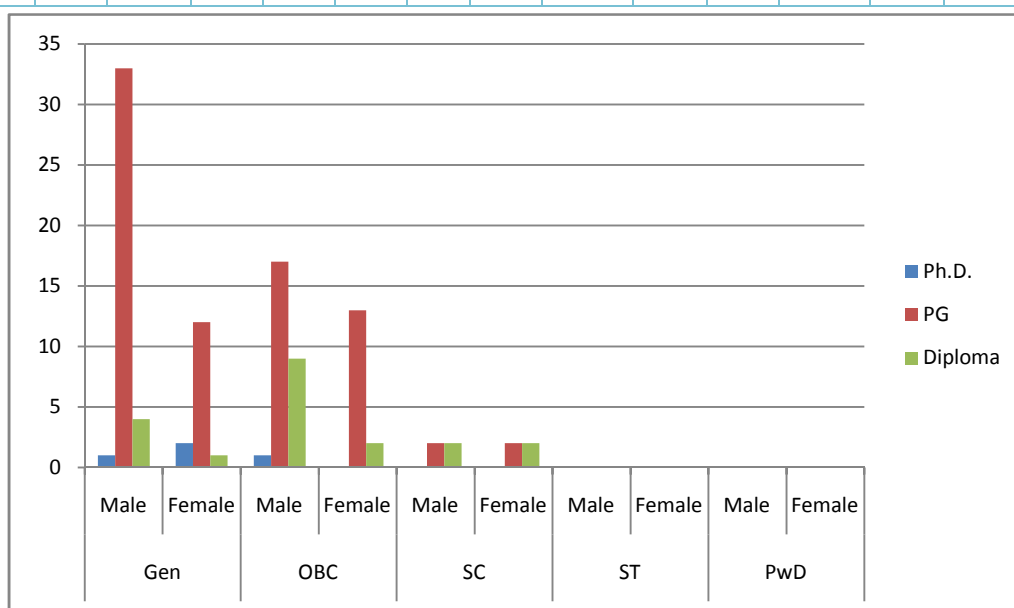

Student Enrollment for the Department

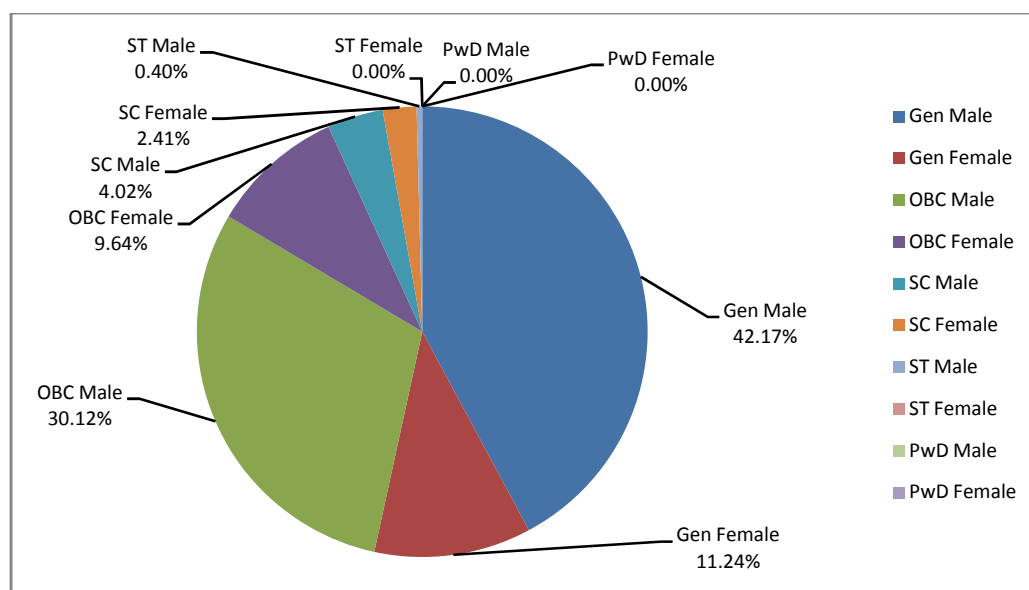

Gender wise distribution of Students

Seminars/Workshops/Conference conducted by the Department/Centre:

S. No.	Name of the Seminar/ Workshop/ Conference	National/ International	Duration and dates	Funding sponsor Agenc(y/ies)	No. of Participants	No. of Papers presented
1.	International Conference on "Advances in Computing, Control & Communication Technology (IAC3T-2018)"	International	3-days (September 21-23, 2018)	IEEE sponsored	155	24

Training/orientation/refresher courses/special lectures conducted by the Centre

S. No.	Name of the Course	Duration and dates	Funding/ sponsor	Speakers
1.	Refresher Course in the area of Computer Application	21 days (March 09-29, 2018)	UGC MHRD Cell, UoA	18 Experts from different organisations like MNNIT, IITa, UPTEC, IISER, Kolkata, Department of Electronics Communication (JK Institute), UoA.
2.	Training for MCA Final Year Students	120 hours followed by Project supervision : March-May, 2019	Conducted by M/s. GTT, Pune	Mr. Rajesh Kumar Sharma
3.	Training for BCA Final Year Students	80 hours followed by Project supervision : March-May, 2019	Conducted by M/s. GTT, Pune	Mr. Rajesh Kumar Sharma

Academic Organizations (headquartered in the Department/Centre):

S. No.	Name	Nature	Objectives
1.	NIELIT, GoI	Accreditation for O Level	Training of students
2.	NIELIT, GoI	Accreditation for CCC Programme	Training of students

Other publications by the Centre:

- The Centre publishes the Newsletter of IEEE, University of Allahabad Student Chapter.

Proposed Courses:

S. No.	Name of Programme	Nature	Duration	Proposed or In process	Intake of Students
1.	Advanced Diploma in Computer Networks and its Applications (ADCNA)	Diploma	1 Year	Already approved by the Academic Committee of IPS, UoA	30
2.	Advanced Diploma in Computer Hardware and its Maintenance (ADCHN)	Diploma	1 Year	Already approved by the Academic Committee of IPS, UoA	30

Proposed Projects/SAP Grants etc.

S. No.	Type of Project/ grant	Title/Name	Duration	Proposed amount	Proposed or In process
1.	Research Project	Criminal Intelligence analysis using Link Prediction in Criminal Networks	3 Years	Rs. 15 lacs	Proposed

Outreach activities:

S.N.	Name of Faculty Member/ Student/ Researcher	Title of the paper presented	Title of Conference/ Seminar etc	Duration of the conference/ assignment	Organized by
1.	Dr. Sarika Yadav	Redundancy Elimination during Data Aggregation in Wireless Sensor Networks for IoT Systems	International Conference on Emerging Trends in Communication, Computing and Electronics-IC3E 2018	3-days (April 13-15, 2018)	J.K. Institute, Dept. of Electronics & Communication, University of Allahabad.

Invited Lectures:

S.No.	Name of the course	Duration and dates	Speakers
1.	Invited Lecture in Faculty Development Program on “Advanced Computer Networks ” on topic ‘Issues and Challenges in wireless Sensor Networks’ at United College Of Engineering and Research.	One day (3 May 2018)	Dr. Sarika Yadav

The Faculty, under the aegis of IEEE, Allahabad Student Chapter, University of Allahabad tries to interact with the deprived students in Schools and Colleges around Allahabad.

Other information (about the Centre):

The course curriculum is regularly updated taking care of the need of the Industry. While updating the curriculum, the Institute not only looks at the standard curriculum of bodies like ACM and IEEE but also consults the Alumni at various places, experts from Industries and experts from reputed Institutions in India and abroad. This exercise helps in bridging the gap between the Academia and Industry.



Inaugural event of IEEE sponsored International Conference (IAC3T-2018) held during September 21-23, 2018



Valedictory Session of IEEE sponsored International Conference (IAC3T-2018) held during September 21-23, 2018



Cultural function organized during IEEE sponsored International Conference (IAC3T-2018) held during September 21-23, 2018



Cultural function organized during IEEE sponsored International Conference (IAC3T-2018) held during September 21-23, 2018

CENTRE OF MEDIA STUDIES

Introduction:

History of the Dept: The Centre of Media Studies was established under the Institute of Professional Studies, University of Allahabad in May 2003. It began with PG Diploma in Photojournalism & Visual Communication in August 2003. The Centre started 3-year degree course B.A. in Media Studies from the session 2009-10 and 5-year Integrated B.Voc. & M.Voc. programme in Media Studies from the session 2015-16.

In recent times, mass communication has undergone a paradigm shift and has emerged as a major area of activity greatly impacting the process of decision-making. It has rapidly acquired importance and prominence and has become a major attraction for students pursuing different academic disciplines. The information Technology Revolution has significantly contributed to the expansion and changing contours of the mass media. It has also posed major challenges for students, teachers and practitioners of the discipline. Rapidly changing technology is transforming the very complexion of the discipline in a manner unknown to any other area of academic activity. The need of the hour undoubtedly is to respond effectively to emerging challenges for maintaining and enhancing the effectiveness of mass media, while simultaneously exploring and expanding the engagement with the new media. Accordingly, the centre continuously evaluates and revises its course curricula so as to effectively meet contemporary challenges thrown up by the fast-changing environment. This enables the effectiveness of the Courses being run by the centre, even in the changed scenario.

Highlights: Centre has adequate facilities, modern class rooms, well equipped computer, Digital Photography & Video Editing Lab, library with Book Bank Facility and well updated Media Research Cell.

Thrust Areas:

The Centre prepares students for employment in the media industry. The courses have been designed for the real world of contemporary media. Students work with industry standard equipment gaining skills in media production (print, broadcast and online), research, communication, reporting and media handling. We believe that a combination of writing and production skills either in print, television, radio or Web ; a broad understanding of the media and the ability to think critically are essential for people who are planning careers in the rapidly evolving media industry.

Programmes of Study:

S. No.	Programme of Study	Duration	No. of Seats	Specialization(s)
1.	M.Voc. in Media Studies	2-year	40	Not Required
2.	B.A. in Media Studies	3-years	46	Not Required
3.	B.Voc. in Media Studies	3-years	40	Not Required

Details of Students, Programme wise and Reservation wise (2018-2019):

Course	Gen			OBC			SC			ST			PwD			TOTAL		
	Male	Female	Total	Male	Female	Total	Male	Female	Total	Male	Female	Total	Male	Female	Total	Male	Female	Total
PG	14	15	29	7	3	10	01	00	01	00	00	00	00	00	00	22	18	40
UG	72	45	117	46	28	74	13	07	20	01	00	01	00	00	00	132	80	212
Total	86	60	146	53	31	84	14	07	21	01	00	01	00	00	00	154	98	252

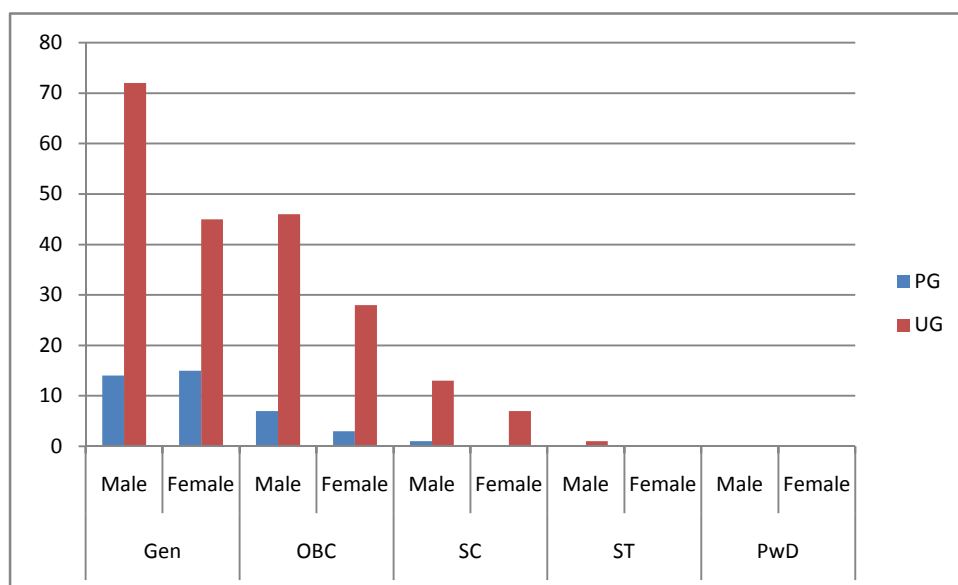

Student Enrollment for the Department

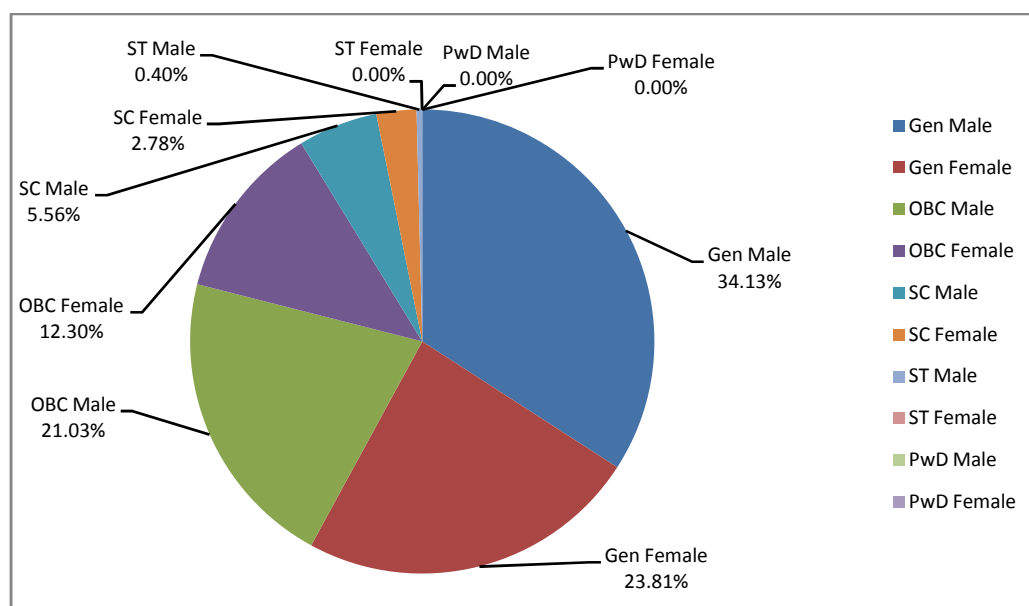

Gender wise distribution of Students

Training/orientation/Workshop/special lectures conducted by the Centre:

S. No.	Name of the course	Duration and dates	Funding/ sponsor	Speakers
1.	Summer School on Radio Production	16 days from 15 th to 30 th May, 2018	IPS	<ul style="list-style-type: none"> Mr. Rehan Fazal, Desk Editor, BBC, New Delhi Mrs. Ritu Rajpoot, Deputy Director, AIR, New Delhi Mr. Anupam Pathak, Programme Executive, AIR, Lucknow Ms. Sarita Brara, AIR, New Delhi
2.	Summer School on Video Production	16 days from 15 th to 30 th	IPS	<ul style="list-style-type: none"> Mr. Shiva Ji, Senior Reporter, Sahara Samay Mr. Sharad Awasthi, Senior Associate Producer MH1

S. No.	Name of the course	Duration and dates	Funding/ sponsor	Speakers
		May, 2018		News Channel, New Delhi • Abhinay Khoparzee Corporate Videomaker
3.	Workshop on Advance Reporting	15 th November, 2019	IPS	• Mr. Harshwardhan Tripathi, Senior Television & Web Journalist, New Delhi
4.	Workshop on Kumbh Mela Media Coverage	07 th to 12 th January, 2019	IPS	• Professor Ram Mohan Pathak, Varanasi • Dr. Ram Naresh Tripathi • Professor Heramb Chaturvedi • Professor Ashish Sexena
5.	Workshop on Digital Photography	12 th to 15 st February, 2019	IPS	• Mr. Umesh Gogna, Jaipur
6.	Workshop on Advertizing Photography	27 th , 28 th February & 1 st March, 2019	NCZCC, Prayagraj	• Mr. Shires R. Karrale
7.	Workshop on Radio Production	09 th to 16 th March, 2019	IPS	• Mr. Anil Srivastava • Ms. Roopam Pandey • Mr. Sunil Shukla
8.	Refresher Course on Media Studies and Governance	25 th March to 14 th April, 2019	UGC-HRDC, University of Allahabad	• Prof. M.P.Dube • Prof. K.B.Pandey • Prof. Ram Mohan Pathak • Prof. Ram Saran Joshi • Mr. Rajesh Badal • Prof. Govind Pandey • Prof. Mukul Srivastav • Prof. Hemant Joshi • Dr. Ram Dutt Tripathi • Prof. Govind Singh • Dr. Mukesh Garg etc. • Refresher Course Coordinator : Dr. Dhananjai Chopra

Awards/Honours/Fellowship received:

S. No.	Name of Faculty Member/ Student who received award	Name of the award	Organization conferring award
1.	Dr. Dhananjai Chopra	Academy Samman	Hindustani Academy, Allahabad
2.	Mr. S. K. Yadav	Award for Excellence	University of Allahabad

Outreach activities

S.N.	Name of Faculty Member	Title of the paper presented / Lecture	Title of Conference/ Seminar etc	Duration of the conference/ assignment	Organized by
1.	Dr. Dhananjai Chopra	Delivered Lectures on Media and Information Literacy	119 th Orientation Programme	April 10, 2018	UGC Human Resource Development Centre, UoA
		Delivered Three Lectures on Information Literacy, Information Management and Information Design	Diploma in Educational Management	May 8-18, 2018	State Institute of Educational Management and Training, Allahabad
		Delivered Lectures on Communication & Public Relation	International Seminar on	April 30 to May 01, 2017	Ayuodhya Research Institute, Ayuodhya and Vyanjana Art and Culture Society, Allahabad
		Delivered Lecture on Environment and Role of Media	Environment Week	June 12, 2018	Indian Farmers Fertilizer Cooperative Ltd. (IFFCO), Allahabad

S.N.	Name of Faculty Member	Title of the paper presented / Lecture	Title of Conference/ Seminar etc	Duration of the conference/ assignment	Organized by
		Delivered Lectures on Information Literacy, Information Management and Information Design	Special Summer School	June , 2018	UGC Human Resource Development Centre, UoA
		Delivered Lectures on Our Society and Development Communication	120 th Orientation Programme	July 26, 2018	UGC Human Resource Development Centre, UoA
		Delivered Lectures on New Trends in Visual Communication	Refresher Course on Visual and Performing Art	August 25, 2018	UGC Human Resource Development Centre, University of Allahabad
		Delivered Lectures on Media and Women	Workshop	August 27-28, 2018	Centre For Women Studies, UoA
		Delivered Two Lectures on Evolution of Print, Electronic and Social Media & Role of Social Media in Shaping Public Opinion	Training Program of Public Relation Officers	September 13, 2018	Indian Railways Institute of Transport Management, Govt. of India, Lucknow
		Delivered Lectures on Takneeki Yug me Hindi	Inauguration of Hindi Pakhwara	September 14, 2018	Rajbhasha Anubhag, University of Allahabad
		Delivered Two Lectures on Media Planning and Public Relation & Role of Social Media in Shaping Public Opinion	Training Program of Public Relation Officers	October 03, 2018	Indian Railways Institute of Transport Management, Govt. of India, Lucknow
		Delivered Lectures on New Communication Tools for Teaching	Training Programs of Co- Coordinators of Block Resource Centre, Uttar Pradesh	September 18 to November 18, 2018	State Institute of Educational Management and Training, Allahabad
		Delivered Lectures on New Medium of Communication & Hindi	121 th Orientation Programme	September 28, 2018	UGC Human Resource Development Centre, UoA
		Delivered Lectures on Media Trial & Law	National Symposium on Law & Humanities	September 22, 2018	Faculty of Law, UoA & Droit Penale : Indian Law Journal on Crime & Criminology
		Delivered Lectures on Mahatma Gandhi as a Journalist	Symposium on 150 Years of Mahatma Gandhi	October 01, 2018	Hindustani Academy, Allahabad
		Participated	International Conference on Advanced in Computing, Control & Communication Technology	September 21-23, 2018	Centre of Computer Education, IPS, UoA
		Presented Research Paper on Jan Samvad me Shiv Shakti	International Conference on Shiv Shakti in Universal Perspective	September 29-30, 2018	Kalidas Academy, MP Govt. and Vyanjana Art & Cultural Society, Allahabad
		Conducted Five day Workshop	News Writing & Editing	November 26 - 30, 2018	Jagat Taran Degree College, Allahabad
		Delivered Three Lectures on Evolution of Print, Electronic and Social Media / Role of Social Media in Shaping Public Opinion / Visual Communication	Training Program of Public Relation Officers	December 24, 2018	Indian Railways Institute of Transport Management, Govt. of India, Lucknow
		Delivered Lectures on Changing Face of Media	National Seminar on Social Responsibilities of Media in Present Scenario	December 23, 2018	Matra Sneh Foundation, Allahabad
		Delivered Lectures on Reciprocal Relationship between Media & Environment	Seminar on Present Scenario of Environment Challenges and Issues	December 16, 2018	CMP Degree Collage, University of Allahabad
		Delivered Lectures on Role of Social Media in Shaping Public Opinion	122 nd Orientation Programme	January 23, 2019	UGC Human Resource Development Centre, UoA
		Delivered Lectures on Blogging And Other Web Media Writing	Workshop on Academic Writing	February 24, 2019	Faculty Development Centre, Ishwar Sharan Degree Collage, UoA
		Delivered Lectures on Development Communication & Our Society	123 rd Orientation Programme	February 27, 2019	UGC Human Resource Development Centre, UoA
2.	Mr. S. K. Yadav	Solo Photo Exhibition	Kumb Katha	January 03-04, 2019	Institute of Professional Studies

S.N.	Name of Faculty Member	Title of the paper presented / Lecture	Title of Conference/ Seminar etc	Duration of the conference/ assignment	Organized by
		Convener	Group Photo Exhibition 'Quest for Immortality'	January 10 to February 10, 2019	Indian Museum, Kolkata, inaugurated by HE Shri Kesari Nath Tripathi, Governer, W.B.
3.	Mr. Sachin Mehrotra	Research Paper on	Inter National Conference on Shiv Shakti in Universal Perspective	September 29-30, 2018	Kalidas Academy, MP Govt. and Vyanjana Art & Cultural Society, Allahabad
4.	Mr. Amit Maurya	Participated	International Conference on Advanced in Computing, Control & Communication Technology	September 21-23, 2018	Centre of Computer Education, IPS, UoA
	Mr. Amit Maurya	Research Paper on Shiv Shakti in Mass Communication	International Conference on Shiv Shakti in Universal Perspective	September 29-30, 2018	Kalidas Academy, MP Govt. and Vyanjana Art & Cultural Society, Allahabad
5.	Ms. Priyanka Mishra	Research Paper on Shiv Shakti in English Literature	International Conference on Shiv Shakti in Universal Perspective	September 29-30, 2018	Kalidas Academy, MP Govt. and Vyanjana Art & Cultural Society, Allahabad
6.	Dr. Ritu Mathur	Research Paper on Sahitya me Shiv	International Conference on Shiv Shakti in Universal Perspective	September 29-30, 2018	Kalidas Academy, MP Govt. and Vyanjana Art & Cultural Society, Allahabad
		Research Paper on Hindi Sahitya Aur Sanskriti Men Samahit Samajik Mulyon ki Avdharna	National Conference	December 06-07, 2018	UPRTOU, Prayagraj
		Sahitya me Kumbh ka Mahatva	International Seminar on Prayag Kumbh	November 29-30, 2018	Samrat Harsh Vardhan Sodh Sansthan Prayagraj
		Participated	Workshop on Prayojan Moolak Hindi aur Bhasha Vikash	February 15-21, 2019	Mahatma Gandhi Antarrastriya Hindi Visva Vidyalay, Prayagraj Branch

PLACEMENT

- After completion of the course, the students went for internships in various organizations. That usually lead to gainful employment in Media Industry. Our students are working with various print, electronic, Broadcast & web media and production houses, to name a few :
- **In Television :** Aaj Tak, News18, Sahara Samay, News 24, NDTV India, ABP News, Zee News, Zee Business, Balaji Films, Lok Sabha TV, DD National, DD Sports, E-TV, India News, MH1, Sony, etc.
- **In Radio :** Red FM, All India Radio
- **In Print Media :** The Times of India, Hindustan, India Today Group, Hindustan Times, Nai Dunia, Punjab Kesari, Amar Ujala, Dainik Jagran, Nav Bharat Times, Dainik Bhaskar, Sahara Times, Rashtriya Sahara, Pioneer, Daily News Activist, Rajasthan Patrika, Compact, I-Next, Delhi Press, Hari Bhumi, Aaj, Revinising, Bindiya, Virat Vaibhav etc.
- **In Web Media :** Lokmat digital, Dept. of Information Technology and Communication Govt. of Rajasthan, FRHI Hotels & Resorts Canada, TV Today Network (Aaj Tak, India Today) Nodia, Jan mudda Web Portal (LKO), India.Com (Noida), Tesu Media Lab (New Delhi), Ad Asia (Noida), Virala India Pvt. Ltd. (LKO)

OTHER ACTIVITIES

- **Industrial visit:** The centre organizes on regular basis visits to Media organizations - News Paper Editorial Offices, Printing Press of News Paper, All India Radio's Studio and Transmission Stations and Doordarshan Kendra.
- **Creative Media Club :** It is an open platform for students to bring out and sharpen their creative fervor. Likewise every previous session, Club continued with its activities in this session. Not only were the academic activities organized but cultural performances were also given in this own club of students. For providing the platform to the merits of students many competitions were organized. Chosen from every class, Club representatives immensely contributed in its organization.

MEDIA RESEARCH CELL

- The Centre has well equipped Media Research Cell. Within Research Cell a diverse group of scholars and student is researching and debating questions of media history; media policy, technologies and practice; literary and cultural history; politics and power and new media developments.

- The work of preserving of works and photographs of eminent writers of Allahabad for digitization of literature of Allahabad is continued by Media Research Cell.
- The Media Research Cell of Center of Media Studies, Institute of Professional Studies, did a research project on the challenges related to drinking water in the city and General elections 2019. For the election project, which commenced in February 2019 and will end in May 2019, analysis of political pages of some of the prominent newspapers, their layout and design as well as cartoons published in them were analyzed in great details.
- To promoting the tendencies of research, Media Research Cell published “Student Journal for Media Literacy” the wall paper ‘Viviksha’ and lab newspaper ‘Swagat’ is being published.

OUTREACH ACTIVITIES OF CENTRE :

- During project work and survey students interact with society on various issues.
- During Summer School, centre organizes village visit to interact with people on their problems and various issues.



Hon'ble Vice Chancellor Prof. R.L. Hangloo Inaugurating Kumbh Photo Exhibition at the Centre



Inauguration of Exhibition by Shri Keshari Nath Tripathi, Hon'ble Governor of West Bengal organised by Indian Museum, Kolkata in association with Centre of Media Studies, University of Allahabad



Renowned Photographer Sireesh R Karrale



Renowned Photographer Umesh Gogna



Senior TV Journalist Harshwardhan Tripathi



Training Of Videography



AIR Allahabad Visit



Amar Ujala Press Visit



Deputy Director AIR Ms Ritu Rajpoot



Doordarshan, Allahabad Visit



Workshop on Kumbh

CENTRE OF FASHION DESIGN & TECHNOLOGY

Introduction:

Centre of Fashion Design & Technology, Institute of Professional Studies, University of Allahabad is the premier institute in UP providing quality education in fashion design and technology. Housed in a modern 1000 sq. meters building, the Centre has class rooms equipped with multimedia equipments, computer lab, textile lab, garment construction lab, a rich library & in house display/show area. It also has an Entrepreneurship Development Cell, which serves as an incubator for budding designers.

Thrust Areas: (Point-wise)

1. Skill Based Education to create professionals for the industry.
2. Revival of craft traditions through new designs to abridge the gap between traditional crafts & consumers.
3. Fabric surface ornamentation & experimentation.
4. Customized Designing to meet varied requirements.
5. Stress on Computer Aided Design (CAD).

Programmes of Study: (Courses Run by the Department/Centre)

S. No.	Programme of Study	Duration	No. of Seats
1.	M.Voc in Fashion Design & Technology	2 years	40
2.	B. A in Fashion Design & Technology	3 years	46
3.	Five year Integrated Program (B.Voc & M.Voc) in Fashion Design & Technology	3+2 years	40
4.	Two Year Advance Diploma In Fashion Design & Technology	2 years	40
5.	Two Year Diploma In Computer Aided Fashion Design	2 years	40

Details of Students, Programme wise and Reservation wise (2018-2019):

Course	Gen			OBC			SC			ST			PwD			TOTAL		
	Male	Female	Total	Male	Female	Total	Male	Female	Total	Male	Female	Total	Male	Female	Total	Male	Female	Total
UG	0	2	2	0	1	1	0	0	0	0	0	0	0	0	0	0	3	3
PG	0	69	50	0	56	59	0	9	11	0	0	0	0	0	0	0	134	134
Diploma	0	18	11	0	7	7	0	4	4	0	0	0	0	0	0	0	29	29
Total	0	89	63	0	64	67	0	13	15	0	0	0	0	0	0	0	166	166

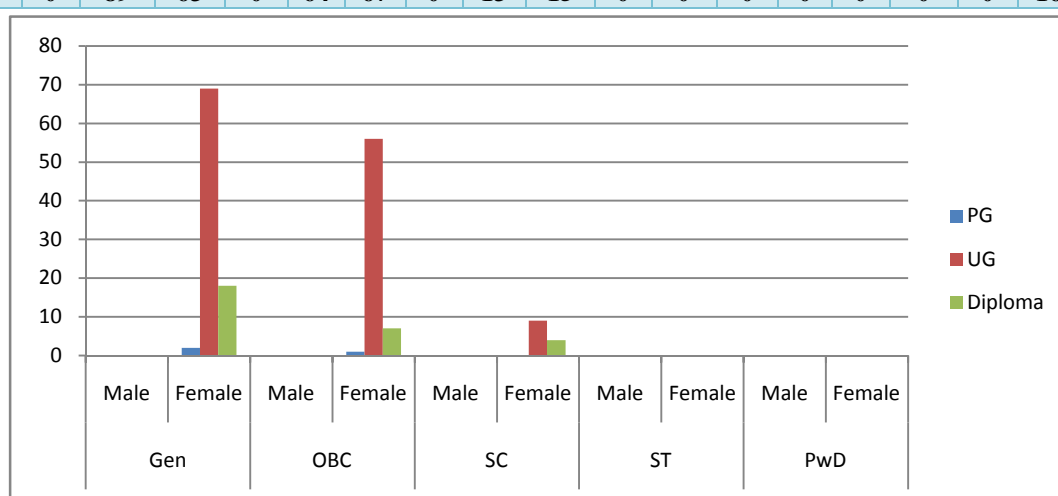

Student Enrollment for the Department

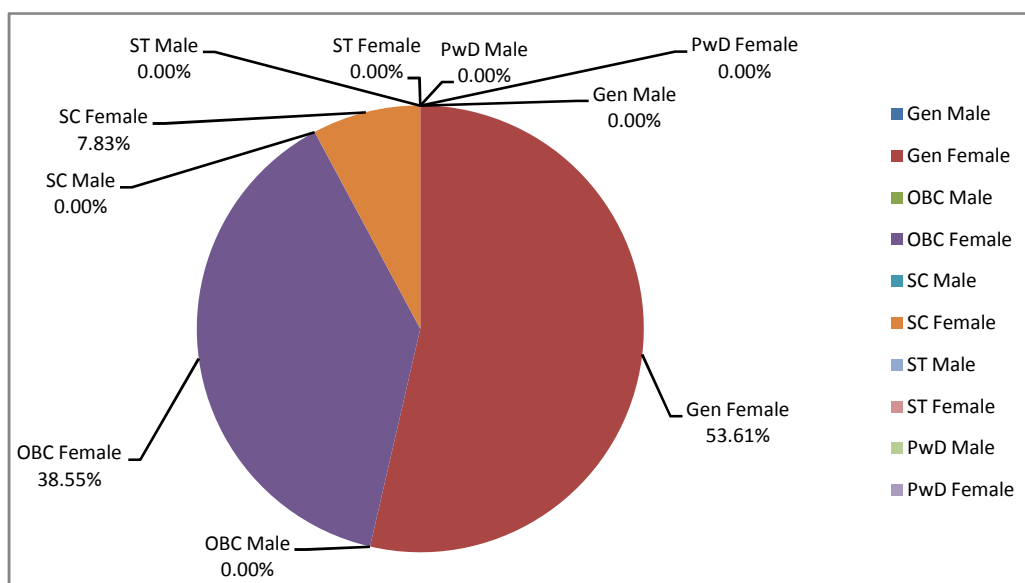

Gender wise distribution of Students

Seminars/Workshops/Conferences conducted by the Department/Centre:

S. No.	Name of the Seminar/ workshop/conference	Duration and dates	No. of Participants
1.	Preparation of Screen and Printing on Cotton using Block and Screen	29 th -31 st October 2018	53
2.	Fashion Photography	16 th & 18 th February 2019	40
3.	Women Entrepreneurship	8 th March 2018	57

Outreach activities:

S. N.	Name of Faculty Member/ Student/ Researcher	Title of the paper presented	Title of Conference/Seminar etc	Duration of the conference/ assignment	Organized by
1.	Dr. Shristi Purwar	लोक पर्वों और मिथकों का डिज़ाइन में महत्व	Global Folk Culture: Traditions & its reflections,	04-06 October, 2018	Department of Dance, Faculty of Performing Arts, BHU, Varanasi, UP.
2.	Dr. Shristi Purwar		14 th Annual Conference of UPUEA	29-30 October, 2018	Giri Institute Of development studies, Lucknow, UP
3.	Dr. Shristi Purwar	Employment and Women Empowerment – A Case Study on Skill Education	International Conference on Sustainable Development: strategies & Emerging Trends,	16-17 November, 2018	Netaji Subhash Chandra Boss Govt. PG College, Lucknow, UP
4.	Dr. Shristi Purwar	Digital Marketing: An Effective Tool of Fashion Marketing	10 th International Conference on Digital Strategies For Organizational Success,	5-7 January, 2019	Prestige Institute of Management, Gwalior, MP
5.	Dr. Shristi Purwar		Attended Workshop on Effective Communication on Public Speaking on Stage,	9 th September 2018	Banasthali Vidhyapith, Rajasthan
6.	Ms Mitali	“Teesri Kasam-Renu’s Vision on Celluloid”	Global Folk Culture: Traditions & its reflections,	04-06 October, 2018	Department of Dance, Faculty of Performing Arts, BHU, Varanasi, UP.
7.	Ms. Anushree Jaiswal	Old coins-as challenge of cultural sustainability and social development	National Seminar on “Sustainable Fashion: An emerging chapter towards a greener world”	15 Feb,2019	AMITY University –Lucknow
8.	Ms. Anushree Jaiswal	Digital Branding-As Building of Consumer’s Experiences	International Conference on “Digital strategies for organizational success”	5-7 Jan,2019	Prestige Institute of management- Gwalior
9.	Ms. Anushree Jaiswal	Diversification of old coins-as cultural	Anushree Jaiswal Conference on “Sustainable	16-17 Nov, 2018	NSCB Govt. Girls P.G College- Lucknow

S. N.	Name of Faculty Member/ Student/ Researcher	Title of the paper presented	Title of Conference/Seminar etc	Duration of the conference/ assignment	Organized by
		sustainability and social development	Development :Strategies & Emerging Trends”		
10	Ms. Anushree Jaiswal	Folk Life and Festivals: An important tool of communication	International Seminar on “Global Folk Culture : Traditions & Its Reflections”	04-06 Oct, 2018	Banaras Hindu University-Varanasi

Other information (about the department/Center)

- Like every year, this year too, the Center of fashion design & Technology organized an exhibition from 01.11.18-03.11.18. The theme of the show was Reflection.
- An attempt was made to incorporate this exciting reflection into various merchandises through colors, shapes and presentation.
- This Exhibition serves as attempt to provide a platform to our students to showcase their creative ideas and to expose them to a real life market experience.
- The exhibition was inaugurated by the director of North Central Zone Cultural Centre (NCZCC), Allahabad, Mr. Inderjeet Grover by lighting the lamp and cutting the ribbon. He fully appreciated the work done by the students of the center and wished them success in their future endeavours.
- The exhibition lasted for three days with very good footfall. People liked the exhibits and wrote encouraging remarks in the visitor’s book, which really boosted the morals of the students.



Workshop on Screen and printing on Cotton using block And screen

Workshop on Fashion photography



Workshop on Women Entrepreneurship

NATIONAL CENTRE OF EXPERIMENTAL MINERALOGY AND PETROLOGY

Introduction:

The National Centre of Experimental Mineralogy and Petrology (NCEMP) is an Institute of the University of Allahabad and is a Research Unit. The main aim of the NCEMP, A.U. is to conduct high pressure-temperature experimental studies pertaining to the Earth, its interior and various materials. Various experiments for the synthesis of glasses, minerals, rocks and super hard materials, measurement of conductivity and seismic velocity in rocks, phase transformations in minerals, and rate of ascent of magma, etc. are routinely conducted using sophisticated high P-T facilities.

There are different types of High P-T equipments available, such as Multi-Anvil High Pressure-Temperature apparatus, Piston-Cylinder equipment and Hydrothermal apparatus. The NCEMP has sophisticated analytical equipments such as Electron Probe Micro Analyzer and Powder XRD equipments for material characterization. It also has a well-equipped workshop and other technical facilities. The Centre has facilities for synthesis of advanced novel materials such as sol-gel synthesis, melt quenching, hot press and ball milling techniques.

Thrust Areas:

- EXPERIMENTAL MINERALOGY AND PETROLOGY
- MATERIAL SYNTHESIS AND CHARACTERIZATION

Faculty members/ Other Academic Staff and their Area of Research:

S. N.	Name of Faculty/ Other Academic Staff	Gender	Category	Designation	Area of Specialization
1.	Professor Jayanta K. Pati	M	GEN	Director	Experimental Mineralogy and Petrology, Meteoritic Impact Cratering Research and Geology of Bundelkhand craton
2.	Dr. Mrigank M. Dwivedi	M	GEN	Engineer	Experimental Mineralogy and Petrology.
3.	Dr. Kamlesh Pandey	M	GEN	Scientist-B	Nano-polymer Physics

Support Staff:

S. N.	Name	Gender	Category	Designation	Work assigned
1.	Alka Gupta	Female	OBC	Technical Assistant	Works related to the laboratory and office
2.	Dinesh K. Jaiswal	Male	OBC	Laboratory Assistant	Works related to the laboratory
3	Ramchandra	Male	SC	Laboratory Attendant	Works related to the laboratories
4	Satyadev	Male	General	Mali	Maintenance of the garden
5	Anil Kumar	Male	SC	Safai Karamchari	Cleaning the rooms, laboratories and campus

Funding received during the period (amount/purpose/agency) to the Department/Centre

S. N.	Funding Agency	Purpose	Amount
1.	Non-Plan : Non Salary (Consumable & Laboratory) Grant	Laboratory Grant	1.00 Lacs

Outreach activities:

S.N.	Name of Faculty Member/ Student/ Researcher	Title of the paper presented	Title of Conference/Seminar etc.	Duration of the conference/ assignment	Organized by
1.	Professor Jayanta K. Pati	Giant quartz veins from Bundelkhand craton and other parts of the world: A comparative analysis.	Konferens Tapak Warisan Negeri Selangor Kearah Pengiktirafan Dunia2018, Shah Alam, Malaysia	November 11-17, 2018	Department of National Heritage, Govt. of Malaysia, Kuala Lumpur
		Shock features and the confirmation of terrestrial impact structures.	National Seminar of Northwest Indian Shield, Mohanlal Sukhadia University, Udaipur, Rajasthan	March 15-16, 2019	Mohanlal Sukhadia University, Udaipur, Rajasthan

S.N.	Name of Faculty Member/ Student/ Researcher	Title of the paper presented	Title of Conference/Seminar etc.	Duration of the conference/ assignment	Organized by
2.	Dr. Mrigank Mauli Dwivedi	Electron Microscopy: Latest Trends.	Refresher Course for Physics	December 2- 21, 2018	Department of Physics, University of Allahabad.
3.	Dr. Kamlesh Pandey	Development and Application of polymer nanocomposite membranes for water filtration.	National Conference on Soft Materials	March 27-28, 2018	Department of Physics, DDU Gorakhpur University, Gorakhpur
		Ion transport study of Polymer Nano Composite Electrolyte for Electrochemical device Application.	National Symposium on Advanced Material Sciences	December 7-8, 2018	Department of Physics, DDU Gorakhpur University, Gorakhpur
		XRD Study: An Experimental Tool.	Refresher Course for Physics	(December 2- 21, 2018)	Department of Physics, University of Allahabad.
		Development of some new polymer membrane for the production of safe drinking water.	National seminar on recent advance in materials science and electronic.	February 27-28, 2019	Department of Physics, Dr. Ram Manohar Lohia Awadh University Ayodhya
		Session Chairman	National Conference on Soft Materials	March 27-28, 2018	Department of Physics, DDU Gorakhpur University, Gorakhpur
		Session Chairman	National seminar on recent advance in materials science and electronic.	February 27-28, 2019	Department of Physics, Dr. Ram Manohar Lohia Awadh University Ayodhya
		Session Chairman	National Conference on Soft Materials	March 27-28, 2018	Department of Physics, DDU Gorakhpur University, Gorakhpur
		Session Chairman	National Conference on Exotic Materials and Devices	January 8-9, 2019	Department Of Physics (MMV), Banaras Hindu University, Varanasi

Other information (about the Center):

1. Twenty eight M.Sc. (Final Year) students and 5 Faculty Members of Chemistry Department, Ewing Christian College, Allahabad visited this institute on April 6, 2018 for experimental training / educational tour.
2. Twenty students with three teachers of the Kendriya Vidyalaya, Old Cantonment, Allahabad visited the NCEMP in August, 2018 under the Science Awareness Program.
3. Fifteen students of M. Sc. (Final Year), Department of Applied Physics, Babasaheb Bhim Rao Ambedkar Central University, Lucknow visited this institute on March 30, 2019 for Experimental Training and Educational Tour.
4. The students of the Department of Earth and Planetary Sciences, University of Allahabad routinely trained in Experimental Mineralogy and Petrology and characterization of Earth and other materials.
5. The NCEMP, A.U. regularly provides its sophisticated analytical facilities on payment basis to the students, researchers and faculty members of various Departments/Centers of the University of Allahabad, constituent colleges and outside Institutes.

DESIGN INNOVATION CENTRE**Introduction:**

Name of the Institute/University: University of Allahabad

PARTICIPATION STATUS:

SPOKES: Rural Innovation Centre, University of Allahabad

Starting Date and month: Aug. 08/2017

Name of the Principal Coordinator: Dr. Manish Arora

Duration of Project: 03 years

Amount Sanctioned: 50 Lakh

Name of Coordinator (spokes): Prof. Anupam Dikshit

Detailed List of Prototype Developed at DIC, IITBBS Hub

S.No	Innovative Project Details
1.	Innovative mechanized sickle
2.	Innovative APK of "RAAHAT" for Global Natural Disaster
3.	Integrated Fish Farming
4.	Development of Low cost Sanitary Napkins for Rural women
5.	Green Roof Technology for sustainable for enhanced vegetable production

Other Miscellaneous Projects

S. No	Miscellaneous Projects
1.	Integrated approach for establishment of Animal Hostel in Kaithwal area of Prayagraj
2.	Training of Rural youth for livelihood by developing various Small Scale Products

SPOKES Innovative Project Details

- **Course detail-** M.Sc. in Designs & Innovations in Rural Technology
- **FINANCIAL STATUTS --- RECURRING & NON RECURRING:** RECURRING
- **EAT STATUS:** EATEN (FINSIHED)

(Combined for the Hub and the Spokes)- FY 2018-19

S.No	Indicators	Q1	Q2	Q3	Q4
1.	Number of New Students Enrolled in DIC courses	09	07	06	06
3.	Number of Innovative products delivered/ improved/initiated	01	NA	02	NA
4.	Numbers of New elective courses	01			
5.	Number of Workshops held	01 (International)			

TOPICS PUBLISHED FOR NATIONAL CONFERENCE ON "MICROFINANCE AND ITS POTENTIAL IN INDIA: RETROSPECT & PROSPECTS" UNDER RIC:

S.No.	Name of Participant	Published Topic
1.	Govind Tripathi	MOBILE BANKING AND ITS BENEFITS

The Indian people lives in rural areas where technology plays important role in Mobile Banking. E-banking has been viewed as a revolution in banking industry. In recent years mobile banking service is emerging as a new dimension of e-banking. Mobile banking use wireless devices such as cell phones, personal digital assistant etc. The mobile phone revolution is sweeping across India and has the potential to dramatically transform the lives of the nation's rural poor. Mobile banking is one of the areas mobile commerce that has extensive communications with other areas of mobile commerce. The one hand, mobile banking is associated with customers and on the other hand, is capable of other firms that are active in the field of electronic commerce, provide effective financial services. In this paper we describe the definition of mobile banking, Evolution and finally to describe number of benefits for users of these services.

TOPICS PUBLISHED FOR COLLABORATIVE INTERNATIONAL CONFERENCE ON “WALLOP OF GLOBLIZATION IN ENGG-MEDI-SCI-AGRI-PHARM-TECH RESEARCH” UNDER RIC:

S.No.	Name of Participant	Published Topic
1.	Anjali Yadav	New product Development: Cost efficient and Bio-degradable Personal Hygiene product
2.	Astha Srivastava	Yagya: Health and Environment
3.	Chanchal	Concept of an ideal Village
4.	Nirbhay Singh	Dry Direct Seeded Rice (DSR)
5.	Rajesh Kumar	An Innovative APK of “RAHAAT” for global Natural Disaster Management
6.	Rohit Shukla	Role of Science and technology in Sustainable Rural Development
7.	Saraswati Yadav	Use of Waste products to make Handmade paper
8.	Kumar Pankaj Pandey	Development of Bioactive organic Supplement for low cost Agricultural Productivity
9.	Vipin Mishra	Studies on “Ornamental Fish farming”

AWARDS & HONORS

1. Best Paper Presentation Award 2nd Prize under Poster Section On “New Product Development: Cost Efficient and Bio-Degradable Personal Hygiene Product” (**International**)
2. Best paper presentation award 3rd prize under poster section on “use of waste products to make handmade paper” (**international**)

Rural Innovation Centre is correctly working Human Development, Economic Development, Environmental development, Awareness & Skill Development of Rural People in which University of Allahabad & District Administration Prayagraj is also involved on different aspects.

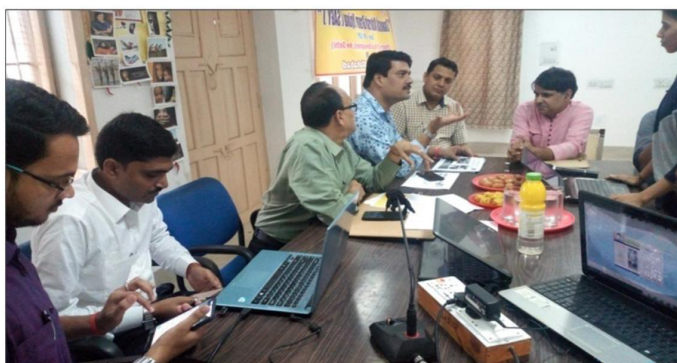

Meeting and Presentation of Mini Project in before of Dr. Manish Arora, Coordinator DIC, BHU (03/09/2018)



Date November 12, 2018, Discussion with BDO Karaon, Payagaraj on Establishment of Animal Hostel (12/11/18)



Raja Mithilesh Kumar< NABARD: Interaction with students and Faculty members of Centre of Science and Society on Skill & Personality Development (22/10/2018)





Presentation of Innovative Ideas and products in presents Dr. Dinesh Sharma, Deputy CM, UP in Paryavaran Kumbh 2018 held at MGKVP, Varanasi (01-02/12/18)



Production Incense Sticks & various small Scale products for training of Rural Youth at Rural Innovation Centre, UoA (Dec. 2018)



Yoga Classes for training of Rural Youth at Rural Innovation Centre, UoA (Jan. 2018)



A special Lecture on Design Based Innovation Opportunity for UG/PG Students in University of Allahabad (By Dr. Manish Arora) and Presentation of Innovative thoughts in National Conference held at DSVV Haridwar U.K. (Jan. 2019 & Feb. 2019)



Collaborative International Conference with RIC University of Allahabad and SVN University SAGAR during 27-28 Feb. 2019

GOVIND BALLABH PANT SOCIAL SCIENCE INSTITUTE

Introduction:

The **Govind Ballabh Pant Social Science Institute** became a Constituent Institute of the University of Allahabad on July 14, 2005, when the University of Allahabad Act, 2005 came into force. Previously it was established as Indian Council of Social Science Research (ICSSR) set up in association with the State Governments, in our case, the Government of Uttar Pradesh in 1980. The Institute undertakes interdisciplinary research in the field of social sciences.

The main areas of research at the Institute include development planning and policy, environment, health and population, human development, rural development and management, culture, power and change, democracy and institutions.

The Institute has M.Phil and Ph.D. in social sciences and a MBA Rural Development Programme. In both programmes the degree is awarded by the University of Allahabad.

Thrust Areas:

The Institute research is now focusing on the following three areas:

- **Economic and Social Policies and strategies wherein** the major concerns include agrarian structure, issues related to land, labour and employment; environment, disaster, poverty and climatic change; food security; development related displacement and most importantly institutions and development. Social policy concerns include population growth and resource constraints, which are of utmost importance to the most densely populated state of Uttar Pradesh.
- **Culture, Politics and Society:** Concept of power, popular cultures, memory and past, orality and printed knowledge of Dalit, subaltern and other marginalised communities, local knowledge, structures and forms of subaltern cultural consciousness and linkage between cultural resources of the communities and process of development..
- **Democratic Processes and Institutions:** concept of justice in democratic processes, relationship between social justice and marginalities, governmentality, new modes of participatory governance, popular aspirations and new social movements, formation of civil societies, state, power and citizenship and public sphere as space of democratic deliberations of post colonial Indian society. Issues of human suffering, forced displacement and migration, human rights and women dignity in contemporary globalisation induced developmental democracy..

Programmes of Study

S.No.	Programme of Study	Duration	No. of Seats	Specialization(s)
1.	Ph.D.	5 years (includes course work)	---	Social Sciences
2.	M.Phil, Ph.D. Integrated Programme	2 years	20	Development Studies
3.	MBA-RD	2 Years	46	Rural Development

Faculty members and their Area of Research:

S. No.	Name of Faculty	Designation	Area of Specialization
1.	Dr. A.R. Mishra	Professor	Political Science
2.	Dr. Archana Singh	Assistant Professor	Caste and Gender
3.	Dr. Badri Narayan	Director /Professor	History
4.	Dr. Bhaskar Majumder	Professor	Economics
5.	Dr. Chandraiah Gopani	Assistant Professor	Political Science
6.	Dr. G.C. Rath	Professor	Sociology
7.	Dr. K.N. Bhatt	Professor	Economics
8.	Dr. Kunal Keshri	Assistant Professor	Demography
9.	Dr. S.K. Pant	Professor	Economics
10.	Dr. Satendra Kumar	Assistant Professor	Sociology
11.	Dr. Sunit Singh	Professor	Economics
12.	Dr. U. Kalpagam	Professor	Professor in Economics

Support Staff:

S. No.	Name	Gender	Category	Designation
1.	Sri Anjesh Kumar	Male	GEN	Computer Programmer
2.	Sri Suresh Tiwari (Till 31.12.2018)	Male	GEN	Section Officer (Admin.)
3.	Sri P.K. Agarwal	Male	GEN	Office Assistant
4.	Sri Jai Kumar Chaubey	Male	GEN	Office Assistant
5.	Sri Lal Bahadur	Male	OBC	Library Assistant
6.	Sri Surendra Singh Negi	Male	GEN	Jr. Office Assistant
7.	Sri B.J. Bose	Male	GEN	Office Assistant
8.	Sri Lal Deo Yadav	Male	OBC	Office Assistant
9.	Sri V.S. Pandey	Male	GEN	Electrician/Plumber
10.	Sri Ramesh Kumar	Male	OBC	Office Assistant (Account)
11.	Sri B.B. Mishra	Male	GEN	Library Assistant
12.	Sri Anwar Ali	Male	GEN	Technical Assistant
13.	Sri Devbrat Singh	Male	GEN	Jr. Office Assistant
14.	Sri Phool Chand	Male	SC	Multi Purpose Worker
15.	Sri Jahid Ali	Male	GEN	Multi Purpose Worker
16.	Sri S.Q. Hoda	Male	GEN	Multi Purpose Worker
17.	Sri Satya Narain (Till 31.01.2019)	Male	GEN	Multi Purpose Worker
18.	Sri Ram Sewak	Male	GEN	Multi Purpose Worker
19.	Sri S.B. Jha	Male	GEN	Multi Purpose Worker
20.	Sri H.P. Adhikari	Male	GEN	Multi Purpose Worker
21.	Sri S.N. Kunwar	Male	GEN	Multi Purpose Worker
22.	Sri Prakash Chand	male	SC	Multi Purpose Worker
23.	Sri Azad	Male	SC	Multi Purpose Worker

Details of Students, Year wise and Reservation wise (2018-2019):

Course	Gen			OBC			SC			ST			PwD			TOTAL		
	Male	Female	Total	Male	Female	Total	Male	Female	Total	Male	Female	Total	Male	Female	Total	Male	Female	Total
Ph.D.	08	06	14	04	03	07	01	01	02	-	-	-	-	-	-	13	10	23
PG	24	15	39	11	04	15	26	08	34	-	-	-	-	-	-	61	27	88
M.Phil	11	10	21	08	05	13	04	02	06	01	-	01	-	-	-	24	17	41
Total	43	31	74	23	12	35	31	11	42	01	-	01	-	-	-	98	54	152

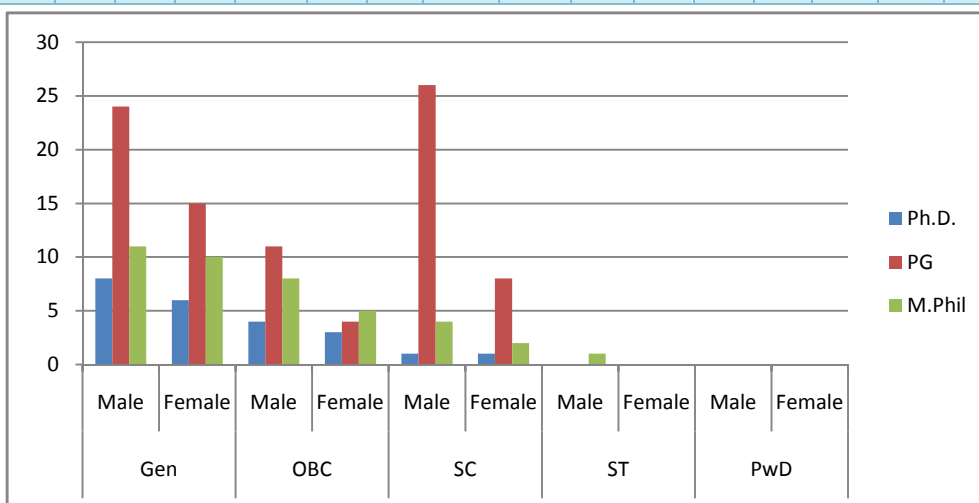

Student Enrollment for the Department

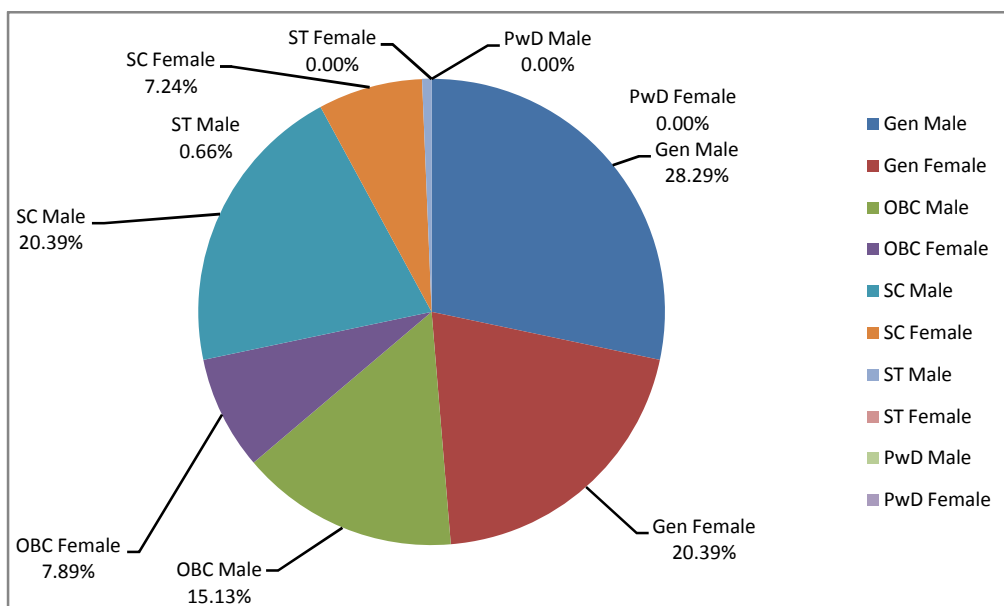

Gender wise distribution of Students

Seminars/Workshops/Conferences conducted by the Department/Centre:

S. No.	Name of the Seminar/workshop/conference	National / International	Duration and dates	Funding/sponsor Agency(ies)
1.	Workshop: How to Write Social Stories	National	19.05.2018	
2.	Exhibition: Kahe Gaile Bidesia Gallery at Manav Vikas Sangrahalaya, GBPSSI	National	13-21.06.2018	In Collaboration with Allahabad Museum
3.	Kumbh Mela Mitra Programme	National	13.09.2018	In Collaboration with Mela Pradhikaran, Prayagraj
4.	Challenges of Social Sciences in Hindi Pradesh	Two days Workshop	14-15.11.2018	In collaboration with CSDS and Nehru Memorial Museum and Library, New Delhi
5.	Workshop on “How to Write Social Stories”	National	19-20.11.2018	
6.	हिन्दी क्षेत्र के देशज संस्रोतों की तलाश	National	3-4.12.2018	In association with Nehru Memorial Museum and Library, New Delhi
7.	Institute Celebrates “No Voter to be left Behind”	National	25.01.2019	
8.	Idea Conclave: On Collaging Futuristic Skills Landscape for New India (A Development Professionals Meet 2019)	National	7-8.03.2019	

Training/orientation/refresher courses/special lectures conducted by the Institute:

S. No.	Special Lectures	Duration and dates	Funding/Sponsor	Speakers
1.	भारत में समाज परिवर्तन की दिशा राज्य केन्द्रित नहीं	27.04.2018	Institute	Dr. Krishna Gopal
2.	First Phase Field Work: Madiga Genealogies and Political Consciousness: Documenting and analyzing the	18.05.2018	Institute	Dr. Chandraiah Gopani

S. No.	Special Lectures	Duration and dates	Funding/ Sponsor	Speakers
	Dalit Shakti Programme (DSP) movement in Telangana			
3.	Common Prophets of Jews, Christians, Muslims and Hindus	25.05.2018	Institute	Professor Bharat Jhunjhunwala
4.	The Concept of Development (Public Lecture)	20.07.2018	Institute	Prof. Prabhat Patnaik
5.	Bhakti Movement	23.07.2018	Institute	Prof. Ashish Tripathi
6.	Sanskritik Itihas mein Bahubhashiya Paripekshya ki Jarurat: Awadh ke Vishesh Sandarbh mein	24.07.2018	Institute	Prof. Francisca Orisini
7.	From Colonial Science to Mega-Science: The Politics of Scientific Knowledge in South Asia (Public Lecture)	11.08.2018	Institute	Prof.DhruvRaina
8.	“धारा के विरुद्ध: स्त्री, हिंदी प्रिंट संस्कृति और अभिलेखागार” (Public Lecture)	24.08. 2018	Institute	Professor Charu Gupta
9.	Manipulating Desires to Destiny: Recruitment of Indentured Labourers in Nineteenth-Century South Asia (Public Lecture)	24.08 2018	Institute	Mr. Sudipto Mitra
10.	Gandhi The Environmentalist (33 rd G.B. Pant Memorial Lecture)	08.09.2018	Institute	Eminent Historian Ramachandra Guha
11.	Rethinking Higher Education: Drawing Lessons from Malviyji’s Contributions	09.09.2018	Institute	Prof. R.G. Harshe
12.	Emerging Framework for Social Security in India	04.10.2018	Institute	Prof. Ravi Srivastava
13.	Self-Employment of Self-Explosion of Labour: A Case of Home-Based Own Account Enterprises of India	11.10.2018	Institute	Prof.N. K.Mishra
14.	Evaluating International Environment and Development Intervention	18.01.2019	Institute	Dr. Anujpam Anand
15.	What it takes for Rural Rejuvenation? An Urban Perspective (Public Lecture)	24.01.2019		Dr. Vinay Prabhakar Shahasrabuddhe
16.	Population and Health Policy Initiatives in India	24.02.2019		Prof. U.V. Somayajulu
17.	Women and Identity Question (Public Lecture)	09.03.2019	Institute	Prof. Roop Rekha Verma
18.	New-Liberalism and Women in India: Governmentality Perspective	27.03.2019		Prof. U. Kalpagam

Funding received during the period (amount/purpose/agency) to the Institute

S. No.	Agency	Purpose	Amount
1.	UGC Salary Head	Annual Grant	6,16,67,000.00
2.	Recurring Head		2,20,00,000.00

Other publications by the Department/Centre

S. No.	Title	Type	Author(s)	Publication
1.	लेकतंत्र : नन्ही सी जान हज़ार दुश्मन	Public Lecture	Prof. Ramesh Dixit	Institute
2.	भारतीय परंपरा में संघर्ष विहीन सुधार	Public Lecture	Dr. Krishna Gopal	Institute
3.	धारा के विरुद्ध : स्त्री, हिंदी प्रिंट संस्कृति और अभिलेखागार	Public Lecture	Dr. Charu Gupta	Institute
4.	From Colonial Science to Mega-Science: The Politics of Scientific Knowledge in South Asia	Public Lecture	Dr. Dhruv Raina	Institute
5.	Technological Disruption Are we Ready?	Public Lecture	Dr. Shakti Sinha	Institute

Outreach Activities

Prof. Badri Narayan Tiwari

- Inaugural Lecture on “Revisiting Indian History through the lens of Art, Architecture and Aesthetics ” at Banasthali Vidyapeeth, Tonk, Rajasthan , organised by ICHR on March 30 and 31, 2019.

- Keynote Address in “Contextualizing Mahatma Gandhi’s Philosophy in the 21st Century: Democracy, Justice, Equality and Non-Violence” at Dr. Ram Manohar Lohiya National Law University, Lucknow on March 29, 2019.
- Inaugural Lecture in 'The Prescient Gandhi: Reviewing the Social, Political, Economic, Moral and Beyond' at Nehru Memorial Museum and Library (NMML), New Delhi on 21 February 2019.
- Badri Narayan Tiwari, Keynote Address in 39th South Asian History Congress at Osmania University, Hyderabad on February 8-10, 2019
- Valedictory Address in "The Dalit Movement in North India: Theory, Praxis and Challenges" at the IAS, Shimla from 26-28 November 2018. Title of the Talk: Reformulating the forms and content of Dalit-Bahujan movement in North India
- Inaugural lecture in Calcutta Research Group and the West Bengal State University, Barasat on “Popular Movements” at the Barasat University campus, Kolkata on Friday, June 22, 2018 organised by Rosa Luxembourg Stiftung–Mahanirban Calcutta Research Group
- Pannel discussion in consultation workshop on “Validation and Documentation process of Best Practices for Study Partners” for “Documentation of Antyodaya Based Best Practices as propounded by Pt. Deen Dayal Upadhyay” on 1^{4th} June 2018 at Gyan Nipun Kendra, Rambhau Mhalgi Prabodhini, Thane, Maharashtra, organised by Indian Social Responsibility Network.
- Special Lecture on “Dalit Politics: Possibilities and Crisis” as part of the Azim Premji University Colloquium Series., Bangalore on April 13, 2018.

Archana Singh

- A National Seminar on “ Revisiting Indian History through the lens of Art, Architecture and Aesthetics ” at Banasthali Vidyapeeth, Tonk, Rajasthan , organised by ICHR on March 30 and 31, 2019. Title of the paper: Social Politics of Making Aesthetics: A discourse on Indian aesthetics
- A National Seminar on “Contextualizing Mahatma Gandhi’s Philosophy in the 21st Century: Democracy, Justice, Equality and Non-Violence” at Dr. Ram Manohar Lohiya National Law University, Lucknow on March 29, 2019. Title of the paper: Gandhi as a feminist.
- A one-day National Conference titled 'The Prescient Gandhi: Reviewing the Social, Political, Economic, Moral and Beyond' at Nehru Memorial Museum and Library (NMML), New Delhi on 21 February 2019. Title of the paper : Re-defining Feminism through Gandhian Lens
- A National Conference on 'Gandhi and Religion: Multidisciplinary Perspectives' at Hindu College, University of Delhi, sponsored by ISAR and ICSSR on February 8 & 9, 2019. Title of the paper : Re-reading Feminism through Gandhian theory
- A National Seminar on "The Dalit Movement in North India: Theory, Praxis and Challenges" at the IAS, Shimla from 26-28 November 2018. Title of the Paper: (Un)revealed Stories : Mapping the Political Subjectivity of Rural Dalit women
- A National Seminar “India’s North-East: A Celebration of (Indigenous) Cultures: A Phenomenological Approach” at St. Joseph College , Jakhama, Nagaland organised by ICPR, New Delhi on 23-25 November 2018. Title of the Paper: “Invisible Lives: De-notified tribes of UP”
- A Collaborative Research Workshop between the Calcutta Research Group and the West Bengal State University, Barasat on “Popular Movements” at the Barasat University campus, Kolkata on Friday, June 22, 2018 organised by Rosa Luxembourg Stiftung–Mahanirban Calcutta Research Group ;Title of the Paper: (Un)-told Stories: A study of Naxal women in Bihar (1970 -90)
- A consultation workshop on “Validation and Documentation process of Best Practices for Study Partners” for “Documentation of Antyodaya Based Best Practices as propounded by Pt. Deen Dayal Upadhyay” on 1^{4th} June 2018 at Gyan Nipun Kendra, Rambhau Mhalgi Prabodhini, Thane, Maharashtra, organised by Indian Social Responsibility Network.
- A two days seminar ' Challenges of Cyclical Inequality and sustainable rising of Marginals with logic of Ambedkar and vision of Brauss' on April 14-15,2018 at BRAUSS Mhow. Title of the Paper: 'Dialogical relationship of Dr. Ambedkar with Dalit women'.

Chandraiah Gopani

- Gopani, Chandraiah. paper title " *Contesting Caste and Gender Hierarchy : Understanding Dalit women literary writings in Telugu*" in National seminar on "Problems of Caste in India: investigating History and Historiography", held on 29th to 30th November, 2018, University of Allahabad. UP.
- " *Dalit leadership and visions of Emancipation: Arigey Ramaswamy life and struggles in Nizam Period*", in special panel on "Dalit History and Politics" in Indian History Congress held on 26-28 February, 2019 in Bhopal, Madhya Pradesh.
- " *Hierarchies of Untouchability: understanding Untouchability among Untouched*", in National Seminar entitled "Contemporary Reflexivity on Dalit Question", held on 19th March 2019, organized by Center for Political Studies. JNU, New Delhi.
- " *Dalit assertions and Critical Pedagogy learning from Dalit students struggles in EFLU and HCU*" in Workshop on " Critical Pedagogy and Cultural sites of learning in India", held on 22 March 2019, organized by Zakir Husain Centre for Educational Studies. JNU, New Delhi.
- Delivered a lecture on " *Telugu Dalit Intellectual History*" held on 12th January 2019, organized by Department of Political Science, Osmania University, Hyderabad.
- Delivered a lecture on " *Inter Caste Marriages- Annihilation of Castes*", held on 18th January 2019, at Osmania University Arts College, Hyderabad, organized by Satya Shodak: A Foundation for Research and Publications. Hyderabad.

OTHER INFORMATION (ABOUT THE INSTITUTE)

Write-ups by **Prof. B.N. Tiwari** in Editorial Page of National Dailies:

दिनांक	पेपर की टाइटिल	पेपर का नाम
31.3.2018	विकास से वंचित तबकों की चिन्ता	दैनिक जागरण
19.4.2018	A Larger Dalit Public Sphere	Indian Express
14.4.2018	सामाजिक प्रेरणा का स्रोत हैं प्रतिमाएँ	दैनिक जागरण
14.4.2018	अम्बेडकर विचार भी, प्रेरणाशक्ति भी	हिन्दुस्तान
7.5.2018	ये भाषण बहुत कुछ कहते हैं	हिन्दुस्तान
5.7.2018	धार्मिक अस्मिता की राजनीति	दैनिक जागरण
16.7.2018	जाति से आगे नहीं सोचती राजनीति	हिन्दुस्तान
30.7.2018	महागठबन्धन की गॉटे और बन्धन	हिन्दुस्तान
7-8-2018	Tribal votes hold the Key To M.P. Assembly Elections	Hindustan Times
31.8.2018	विरोध को जगह देकर ही चल पाएगा यह लोकतंत्र	हिन्दुस्तान
3.9.2018	महागठबन्धन में विखराव के संकेत	दैनिक जागरण
10.9.2018	जाति जनगणना का अमृत और विष	हिन्दुस्तान
11-9-2018	Importance of the Bahujan Samaj Party	The Hindu
15.10.2018	राजनीति में उभरते युवा	दैनिक जागरण
7.11.2018	विकास की आंकांक्षा जगाने का जतन	दैनिक जागरण
8.11.2018	अभी नहीं रुकेगी नाम की राजनीति	हिन्दुस्तान
3-12-2018	Its back to the Hindutva Card in UP	Hindustan Times
21.11.2018	अब विपक्ष की दिशा तय होगी	अमर उजाला
23.11.2018	बड़े मकसद के लिए छोटी कुर्बानी	दैनिक जागरण
7.12.2018	आकामक बोल की राजनीति में सुनने की बात	हिन्दुस्तान
21.12.2018	रोजगार की स्थानीय अवसर और बाहर से आए लोग	हिन्दुस्तान
18.10.2018	Charism vs. The Collective	Out Look
21.12.2018	आसान नहीं आगे की लड़ाई	दैनिक जागरण
26.12.2018	प्रवास पर टिकी बुनियाद	अमर उजाला
9.1.2019	बराबरी की बलवती होती भावना	दैनिक जागरण
29.1.2019	सामाजिक प्रयोजनों से जुड़ता कुम्भ	दैनिक जागरण
18.2.2019	महिलाएँ जो निभाएँगी केन्द्रीय भूमिकाएँ	हिन्दुस्तान
15.4.2019	दलित विमर्श का हाशिर्ष पर जाना	हिन्दुस्तान
15.4.2019	विकास की घारा से दूर अदृश्य समाज	दैनिक जागरण

Prof. B.N. Tiwari :

- Key Resource Person in a one week programme on Qualitative Methods in Social Sciences: Ethnography, Narratives and Social Stories at Omeo Kumar Das Institute of Social Change and Development, Guwahati in

collaboration with G B Pant Social Science Institute, Allahabad, Council for Social Development, Delhi & Anthropological Survey of India, Govt. of India on June 11-15, 2019

- Key Resource Person in a one week programme on **Qualitative Methods in Social Sciences: Ethnography, Narratives and Social Stories** at Council; for Social Development, New Delhi, collaborated by Council for Social Development, New Delhi, in collaboration with G B Pant Social Science Institute, Allahabad, & Anthropological Survey of India, Govt. of India on March 11- 15, 2019

Archana Singh

- Resource Person in a one week programme on **Qualitative Methods in Social Sciences: Ethnography, Narratives and Social Stories** at Omeo Kumar Das Institute of Social Change and Development, Guwahati in collaboration with G B Pant Social Science Institute, Allahabad, Council for Social Development, Delhi & Anthropological Survey of India, Govt. of India on June 11-15, 2019
- Resource Person in a one week programme on **Qualitative Methods in Social Sciences: Ethnography, Narratives and Social Stories** at Council; for Social Development, New Delhi, collaborated by Council for Social Development, New Delhi, in collaboration with G B Pant Social Science Institute, Allahabad, & Anthropological Survey of India, Govt. of India on March 11- 15, 2019
- **Coordinated a two days workshop** ' How to write Social Stories II' at G B Pant Social Science Institute, Allahabad on November 19-20,2018
- **Coordinated a two days workshop** ' How to write Social Stories I' at G B Pant Social Science Institute, Allahabad on May 19-20,2018

Kunal Keshri

- Invited to present a paper entitled "Public Health in Uttar Pradesh" as resource person in the national Seminar entitled Paradigm Shift of the Indian Economy – New Growth Forces with Greater Inclusiveness during 22-24 January, 2019, which was organized by Dr. Shankar Dayal Sharma Institute of Democracy, University of Lucknow.
- Delivered an invited lecture on "Population, Development and Demographic Dividend" in the Faculty Induction Training Programme at Faculty Development Centre at Iswar Sharan P G College, University of Allahabad on November 29, 2018.
- Delivered an invited lecture on "Quantitative Techniques in Social Sciences" in the Refresher Course (UGC-HRDC) in Library Sciences, organised by University of Allahabad on December 07, 2018.
- Delivered an invited lecture on "Socioeconomic Data from Census and NSSO" in the Refresher Course (UGC-HRDC) in Library Sciences, organised by University of Allahabad on December 07, 2018.

RAJIV GANDHI CHAIR IN CONTEMPORARY STUDIES**Lectures Organized by the Chair**

- A lecture on Constitutional Dimensions of Kashmir Problem was delivered by Prof. R L Hangloo, Hon'ble Vice-chancellor of the University of Allahabad on 9 January 2019. The lecture was held in the Seminar Hall of the Department of Political Science, University of Allahabad from 2.00 pm.
- Two lectures on India as Republic: Harmony between South & North: Needed Measures was delivered by Rapolu Ananda Bhaskar, a senior journalist, and Dr. Pramod Sharma, JNU, New Delhi 30 January 2019. The lecture was held at the Rajiv Gandhi Chair in Contemporary Studies, University of Allahabad from 2.00 pm.

Publications by the Chair

- Minu Jha, India and the Civil Nuclear Liability Regime, *Indian Journal of Public Administration*, Sage Publications, April-June, 2019, New Delhi.

Brijesh Kumar, SRF, R G Chair

- Brijesh Kumar, Senior Research Fellow's Pre-submission was held in the Rajiv Gandhi Chairman's office on 18 May 2018.
- Brijesh Kumar, Senior Research Fellow, submitted his Ph.D. thesis in January 2019.

STUDENTS' WELFARE ACTIVITIES

OFFICE OF DEAN STUDENTS' WELFARE

The year that has gone by was marked with the DSW set up making tangible gains by way of consolidation and giving thrust to its major initiatives. The year also erased the shadows/pangs of transition in a large measure. Better amenities, larger financial allocation in assistance to students, better healthcare, hygiene, spurring sporting activities and, the last but not least, the hard fought and won peace and tranquility in hostels and the campus have been the cornerstone of the multifaceted activities of the preceding year. Progress and development have been at the core of all DSW and his team endeavors. The progress, though slow but surefooted, has instilled yet greater resolve to pursue the unfinished agenda of growth. Unquestionably the mood at the DSW set up has been upbeat and triumphant.

Here are some of the modest successes achieved through sustained team spirit and camaraderie to which the DSW Board, teachers, officers, staff, and students have contributed immensely.

Welfare Measures (General)

Disbursal of Rs. 20,000,00/- as scholarship to poor though meritorious students under the Government of India sponsored "Merit cum Means" Based Scheme .

Financial assistance towards meeting partial expenses for medical treatment to students suffering from serious diseases, accidental injuries etc.

Health Facilities of Students:

- University Health Centre is running for the medical welfare of students and employees of the University under the supervision of Senior Medical Officer. One homoeopathy doctor was also engaged by the University. Two ambulance was working for the transport facility of the University.

Students Union Election:

- Election for the student union was held in the session 2017-18 . The students union office -bearers given encouragement, aid, and guidance, to organize various student related activities. As such, a large number of seminars , conferences, and, Departmental cultural program were held under the auspices of student union .

Welfare of Physically challenged students.

Jawaharlal Nehru Centre for Differently Abled Students has been the nodal Centre for facilitating and supporting academic and digital inclusion for the differently abled students of the University of Allahabad. In the session 2016-2017, it continued to provide the necessary academic resources for the students. It is equipped with computers, scanners , several screen reading software's (specially meant for visually challenged) etc. The Centre was established in 2009 and, therefore, it was a high time overhaul these facilities. In pursuance of this 11 computer systems were overhauled for their efficient functioning. Further, the problem of access and the provision of barrier free environment for the differently abled students was addressed. It was declared by the University Administration that barrier free buildings are a necessary pre-condition for facilitating the educational inclusion of differently abled students and, in pursuance of this, designs for railing and ramps etc have been cleared for the old departmental building of the University. At present the work for provision of barrier- free building is at an advance stage. The grievances of the differently abled students regarding hostel allocation were addressed and they were allotted room in the University hostels on a priority basis. Also, given the constraint of space in the hostel, the Jawaharlal Nehru Centre for the Differently Abled Students was activity involved in facilitating the admission of students in the hostels for the visually-challenged students run by the State Government. Due to the support and facilitation by the Centre even some visually challenged student could do well in the competitive examination for professional courses and jobs. The differently abled students who could not be get admission in University hostels were accommodated in State Government hostel through the efforts of the centre.

Admission of physically challenged students

DSW office is continuously working with the Director, Admissions to facilitate physically challenged candidates to get admission in different courses of the University(UG+PG+Law+Professional) by organizing medical board for examining

disability of the candidates seeking admission under physically challenged category, and recommend genuine candidates for admission

Hostels (Boys and Girls)

- In compliance of the order passed by the Hon'ble High court, all the University and Trust hostels were vacated with the help of District & Police administration.
- The internet Wi Fi facility of the hostels of the university was upgraded.
- Installation of Water purifiers to ensure supply of pure drinking water for the residents of the hostels and students at large on the campuses.
- Pure drinking water and sanitation for hostels and University departments

Measures to enforce discipline, law and order in the Hostels and the Campuses

- Setting up of anti ragging cell to monitor/redress the menace of ragging in hostels and campuses. Teams made massive surprise checks and succeeded in containing incidence of ragging. Thankfully constant vigil resulted in no serious cases of ragging.
- Periodic raids/strict vigilance of combined teams of DSW/Proctorial board and Warden/Superintendent of the hostels carried out to evict anti social elements/ students with criminal records. Tough measures to enforce discipline yielded positive results.
- Organized Meditation/Yoga and health check up camps in the hostels & University Health Centre in collaboration with various prominent NGOs working in this area. Health check up camps for girl students organized on Sundays in collaboration with Women's Advisory Board (WAB) were largely attended

Scholarship and financial assistance to the students by the DSW office

- Disbursal of Rs. 20,000,00/- as scholarship to poor though meritorious students under the Government of India sponsored Merit cum Means Based Scheme. The scholarship awarded to 400 students of UG/PG/ IPS/ Professional courses @ Rs. 5000/- per student for a session. For the session 2017-18, 353 eligible students were awarded McM scholarship.
- Financial assistance towards meeting partial expenses for medical treatment to students suffering from serious diseases, accidental injuries etc.
- Financial assistant for the purchase of books to the poor students out of Poor Boys Funds account. For the session 2017-18, 136 eligible students were awarded assistance.
- Financial assistant for the cultural programme in the various departments & University hostels of the University were granted .
- Financial assistance was also given to students of different units of the University for organizing their annual functions. The Jawaharlal Nehru Centre for Differently abled students organized International Day for persons with disability under the aegis of DSW office.

JAWAHARLAL NEHRU CENTRE FOR DIFFERENTLY ABLED STUDENTS

Established in 2009 Jawaharlal Nehru Centre for Differently abled Students is an enabling unit for the differently-abled/ *divyang* students. In 2018-19 38 students were enrolled with it. The Center has a computer lab with e books as well as screen reading software like NVDA for the visually challenged persons. The upgraded infrastructure involving equipments worth more than Rs.5.00 lakh acquired in preceding was inaugurated and became functional in 2018-19. Sixteen more e-books were added to the center's existing learning resources which consist of 392 books in 12 different subjects as well as Braille books available in the Central Library of the University. A total of 623 visits were made by students to use the learning resources of the center. Like last year more than 30 students got accommodation in State Government Hostel (Rashtriya Ucha Siksha Adhyanrat Dhristibadhith Chatravas) especially designed for the *divyang*.

Jawaharlal Nehru Center for Differently Abled Students JNCDS of University of Allahabad (A.U) organized White Cane Day Function on 15 October 2018 in order to spread awareness for the rights, needs and capabilities of the visually challenged. Also, on December 3 2018 it organized a programme at Nirala Art Gallery Sabhagar to celebrate International Day for Person with Disability for 2018. The theme for this programme, as mandated by United Nation, was Empowering the Disabled and Strengthening Equality with Social Inclusion The Chief Guest of function was Vivek Prakash (Chairman, Railway Recruitment Cell, NCR) and Ms. Manisha Goyal (DY.CME, NCR). In the first segment a Debate Competition on 'National Swachh Bharat Mission : Successes and Challenges' was organized wherein Prof Ashish Saxena (Head , Sociology Deptt) Dr, Sanjay Kumar (Urdu Deptt.) and Dr. Saroj Yadav (Education Deptt.) of A.U judged the participants. Dr. Alok Prasad (Coordinator, JNCDS) anchored the function while Suman Yadav (Research Scholar, Music Deptt.) presented vote of Thanks. Devendra Gupta (Researcher, Music Department, AU) and his musical group presented *ghazals* of famous poets and singers. In Debate Competition Aditya Tiwari, Mukesh Vaishya and Pankaj Bhai Patel secured First, Second and Third positions respectively.

A special intervention in 2018-19 was that a supernumerary for the *divyangs* in all the department for the PhD admissions was created in order to give them adequate representation in research.

SPORTS BOARD

Introduction:

The aim and object of the Sports Board are to promote physical well being of the University students in general, by providing facilities for game and sports and by organizing competitions and tournaments. Keeping in mind, the aims and objectivities, the activities of the Board are planned. In spite of the infrastructural deficiency and resource crunch, the Board has been able to achieve National level achievements. A brief report about the achievements of the Board are as follows:

1. UNIVERSITY LEVEL ACTIVITY.

Selection trials/Coaching Camps were organized in different discipline for the final selection of the University teams. The selected teams participated in U.P. Championships/Local Tournaments before their final departure for the Inter University Tournaments.

2. INTER UNIVERSITY LEVEL ACTIVITY

Total number of 31 (Thirty one) teams participated in North Zone and All India Inter University Tournaments. The break up of the participating teams is as below:

(i) ZONAL LEVEL TEAMS (NORTH ZONE)

Badminton (M), Badminton (W), Basketball (M), Basketball (W), Chess (M), Chess(W), Cricket (M), Football (M), Handball (M), Hockey (M), Kabaddi (M), Kabaddi (W), Kho-Kho (M), Kho-Kho (W), Table-Tennis (M), Table- Tennis (W), Tennis (M) and Volleyball (M) teams participated in North Zone Inter University Tournaments.

(ii) INTER ZONAL LEVEL TEAM

Table-Tennis (W) team secured 3rd place in North Zone and qualified for Inter Zonal Inter University Tournament.

(iii) ALL INDIA LEVEL TEAMS

Athletic (M), Athletics (W), Boxing (M), Gymnastic (M), Squash (M), Squash (W), Swimming (M), Swimming (W), Taekwondo (M), Taekwondo (W), Wrestling (M), Weight Lifting (M) and Judo (W) teams participated in All India Inter University Tournaments.

ACHIEVEMENTS / AWARDS

Table Tennis (W) team secured 3rd place in North Zone Inter University Tournament held at Mahatma Jyotiba Phule University Bareilly and qualified for Inter Zonal Inter University Tournament held at SRM University, Chennai.

NATIONAL SERVICE SCHEME (NSS)**NATIONAL SERVICE SCHEME****"Not Me But You"****Achievement of the year**

- Kumbhsewa Mitra and PravasiBhartiyaDiwas Felicitation by Vice President of India
- 2000 NSS volunteers of University of Allahabad and constituent colleges were felicitated by vice president of India Shri Venkatraghawan for their dedicated services as Kumbha sewa Mitra at historical Prayagraj Mahakumbh 2019 and PravasiBhartiyaDiwas
- 40 volunteers from CMP Degree College Unit of University of Allahabad felicitated by Nobel laureate Sri Kailash Satyarthi Ji for giving services with their team

International level Achievement

- Volunteer Shikha Mishra who represented UP contingent in Republic Day parade 2017 is nominated for participating in China international delegation tentatively scheduled in July 2019

National level achievement

- Dr Manju Singh, Programme Coordinator University of Allahabad was nominated by District Electoral Commissioner UTTAR PRADESH for training of Electoral literacy club at New Delhi for workshop on June 20-21, 2018 New Delhi
- Gaurav Gupta winner of Allahabad District Youth Parliament, second Runner up at State level Youth parliament was invited and attended National youth parliament, prime minister Shri Narendra Modi motivated volunteers for active participation at Vigyan Bhavan New Delhi on Feb 28, 2019
- Volunteer Aman Singh ISDC, UoA represented University of Allahabad at Republic Day parade Camp, New Delhi 2019 from January 01-31, 2019
- Volunteers Jyotsana Singh UoA, Yogya Singh SPM UoA, Aman Singh ISDC UoA represented
- University of Allahabad at Pre Republic-Day parade at Ranchi, Jharkhand from 03-10 October 2018
- 04 volunteers Uday Pratap Singh UoA, Rohit Singh UoA, Sapna UoA, Zebaish UoA represented University of Allahabad at Bareilly National Integration Camp, UP October 15-19, 2018
- Programme Officer Dr Himanshu Yadav, Assistant professor Political Science SPM college UoA represented UP contingent with 10 volunteers of University of Allahabad Dushyant Sharma, Sandeep Yadav, Saumya, Chandrakant Mishra, Subhash, Srishti Arora, Aastha Gupta, Shruti Anand Chennai National Integration Camp 2019 from Dec 10-17, 2019 and won several awards

State level Award

- Dr Manju Singh was felicitated by Regional Director NSS, Ministry of Youth Affairs and Sports Govt of India Dr Ashok Shrotri for successfully organising District level Youth parliament on 28.01.2019 at North Hall University of Allahabad
- Dr Kalpana Verma in charge Programme officer AYKD UoA and Volunteer Vikash Kumar UoA will be awarded Best Programme Officer 2019 and Best Volunteer Award 2019 of State of UP at a grand Programme by Chief Minister Shri Yogi Ji on September 24, 2019 at Indira Pratishthan Lucknow UP

District level Award

- District Magistrate Prayagraj Shri Suhas LY awarded Programme Coordinator Dr Manju Singh for election awareness programmes held at Allahabad District as SVEEP Coordinator Election with Programme officer Dr Arvind Mishra, Dr Jyoti Kapoor, Dr Anvita Raghuvanshi, Dr Anjana Srivastava, Volunteers Vikash Kumar, Purnimatiripathi, Sandeep YADAV, Rubi, Pallavi Chariat MNNIT auditorium on Voter Awareness Day January 25, 2019

University level Award

- All volunteers who participated in national and international events in academic year 2018-19 at
- National level were felicitated by honorable Vice Chancellor Prof RL Hangloo at Republic Day camp

- 2019 at Senate Hall
- Volunteer ZebaishUoA, felicitated for summer internship Swachch Bharat campaign by Vice Chancellor at Republic day Jan 26,2019
- Dr Manju Singh felicitated by UNITED COLLEGE TedXNaini Women's Award for youth development initiatives on Dec 21 ,2019



Run for Unit (Rashtriya Ekta Diwas)



Blood donation camp



Students at Divya Kumbh, Prayagraj



NATIONAL CADET CORPS (NCC), UNIVERSITY OF ALLAHABAD

NCC BN, University of Allahabad, Prayagraj-211002. University have four wings, viz. 1/15UP NCC BN, 6 UP NCC BN, Naval Unit and 2 UP Artillery BN. University as such has senior wing for Girls cadets and Boys Cadets respectively. The total intake cadets are 452. All the units have Associate NCC Officer (ANO). Dr.(Lt.) Munish Kumar is ANO for 1/15 UP NCC BN, Dr. (Lt.) Neetu Mishra is ANO for 6 UP NCC BN, Dr. (Lt.) Raju Paraghi is ANO for 2 UP NCC Art. and Dr. (Lt.) Bhima Kumar. SSB classes are run on regular basis and in last few years university have produced several officers in Indian army.

1/15 UP NCC BN, University of Allahabad (2018-2019)

- 302 boys have got NCC “C” certificate
- 2000 girls cadet have got NCC “C” certificate
- 1 cadets has represented Republic day parade
- More than 25 cadets have joined Indian Army, Para-military force and UP Police
- On regular basis we organize rally, nukar natak to educate people on Beti-Bachayo, beti-padhayoo, Swachh Bharat Abhiyan, Ganga cleaning, Blood donation camp, Health awareness, tree plantation and various schemes for Government of India



Health Awareness Rally



Beti bachao beti padhao



Republic Day celebration



Ganga Cleaning at Sangam Nose

INTERNATIONAL STUDENTS ADVISOR'S OFFICE

Mission and Objectives

The Mission of the University of Allahabad is to be a global, socially conscious Center of Excellence in the conservation, creation, advancement and dissemination of knowledge, equipped to take up challenges of the enormous change taking place all around and committed to empower its faculty and students to contribute meaningfully to economic, technological, social development and progress. In order to have a Global outreach, the University is committed to advance the same facility to International Students and impart quality education to them as well.

The living ambience and social milieu of the campus is also reflected in an integrated, with a new focus on an interdisciplinary approach in teaching and research. There is freedom to define and design course content or start new courses. Research themes evolve with new developments in the area and the interface between different areas of study. Everyone at the university competes with himself/herself to excel in their own field of research. The University of Allahabad is academically and socially a vibrant place where all have space to express their views.

The four faculties and thirty five departments along with special centres of the university produce high quality research publications, books, working papers and Ph.D. theses. The University alumni occupy important positions, in academics, government, private sector, and in fact in all walks of life.

The University through its International Students Advising and Services (ISAS) will continue to play a major role globally in the field of higher education, by seeding new ideas and creating knowledge, and by imparting high level of training with values and social commitment to all its International Students as well. Since its inception on July 14, 2005 as a Central University, the University has reaffirmed to live up to these ideals. We believe that the University is responsible not just for imparting knowledge, but for disseminating knowledge in society; so as to build a better Society at national and international levels in future.

Present International Student Advisor & Board:

Prof. Sanjeev Bhadauria, Professor & Former HOD, Defence & Strategic Studies

The University has a separate International Students Advisory Board under the International Student Advisor with the Vice Chancellor as the Chairperson to advise and facilitate the International Students.

International Connection

The University stands for humanism and tolerance, for reason, for adventure of ideas and for the search for truth. It stands for the forward march of the human race towards ever higher objectives. The Universities proposes to discharge its duties adequately, and aspires to provide to its International Students the following facilities:

- **Single Window Services**
- **Networking**
- **Interfacing**
- **Wireless connectivity**
- **Innovation**
- **Interaction**
- **Competitive and Affordable Education**

With a view to assist international students, University has established an International Students Office in the University campus. The University of Allahabad model for Internationalization of Higher Education has these unique features:

1. In the age of globalization, the University has set out to make its presence felt globally through internationalization of its programmes and opening new avenues of association for global student community.
2. With the approval of UGC and the Central Government, the International Student Advisors' Office of the University proposes to have a number of MOUs signed with leading Universities whereby sharing of the facilities in the university and exchange of Faculty and students can be made possible.
3. Besides looking after admissions and eligibility, the Office of the International Student Advisor coordinates with ICCR, Ministry of External Affairs, different embassies and consulates for various purposes including grant/award of Scholarships.

Hostel Accommodation Facility:

The University maintains a separate boys' hostel for International Students and female students are accommodated in a separate girls' hostel.

Very soon, the University of Allahabad with the support of the Ministry of Human Resource Development (HRD), Government of India will construct a new hostel for accommodating 140 students with separate state of the art self sustained apartments adjacent to the present International House.

Sponsored Student Programs

The Sponsored Student Program is a part of International Student Advising and Services (ISAS) at the University of Allahabad with the specific goal of assisting sponsors and sponsored students by:

- Supporting the academic goals of sponsored students and their sponsors.
- Providing records of student's academic standing when requested.
- Facilitating communication between students and sponsors to help with financial and administrative questions.
- Working with the Sponsoring Agencies as well as the Foreign Registration Office to answer sponsored students' questions and to help students maintain and understand their immigration status.

Services for Sponsored Students:

- A special orientation session for sponsored students
- Help with providing medical facilities when required. Facilitation is given to Sponsored Students to avail medical insurance, if the student desires.
- Help sponsored students communicate with Academic Departments, and Sponsoring Agencies.
- Reminders for students with expiring financial guarantee/support letters.

Services for the Sponsor:

- A special orientation session for sponsored students.
- Student transcripts to show academic standing upon request.
- Special campus meetings for sponsors to meet with their students.
- Manage Financial Guarantee for Sponsorship

Activities of the International Student Office:

The University of Allahabad attracts a large number of foreign students in comparison to all other Indian Universities. Apart from offering a multi-cultural and inter-disciplinary learning environment, one of the main reasons for studying in Allahabad is the manageable cost of living and a favourable environment for education. Currently, we have around 145 students, from over 15 countries studying at the University and its affiliated colleges.

The International Students Office of the University of Allahabad assisted the International Students' Community, in acquiring information about the various courses, colleges, tuition fee structure, eligibility, accommodation, health insurance and the accommodation offered by the University. It was also operative in arranging for the students' admissions and their overall welfare.

The International Student Office administered the special over and above quota of International Students, created jointly by the Ministry of External Affairs and Ministry of Human Resources and Development (MEA & MHRD) Government of India. The International Student Office acting as the nodal agency that coordinates all the activities related to the admission of International Students, provided facilities through a unique single-window system. Apart from handling the admissions and eligibility procedures, the International Student Office coordinated with the Indian Council for Cultural Research (ICCR), Ministry of External Affairs and Ministry of Human Resources and Development (MEA & MHRD) and with different Embassies and Consulates for various purposes including getting scholarships as well as administering MoU's with International Partners of higher education.

The International Student Office acted as a liaison between the students, the various Departmental Heads, and the Heads of Colleges and Institutions affiliated under the University of Allahabad as well as the Heads of Chancery, Embassies, Consulates, their educational counselors and their educational wings, throughout the world or with any other agencies of the Government of India or the Government of other countries.

- In order to improve the procedures and to be versed with the best practices in other Academic bodies and thus boost the efficiency of the ISA's Office, the Vice Chancellor Prof. Rattan Lal Hangloo and the ISA Prof. Sanjeev Bhadauria are constantly in contact with the Indian Council for Cultural Relations (ICCR), New Delhi and other academic Institutions, Institutes and Organizations.

DATA ON INTERNATIONAL STUDENTS

Country Name	BA		B.SC		B.COM		B.C.A.		TOTAL UG	M.A.		M.SC		M.COM		TOTAL PG	OTHERS	Ph.D.		TOTAL
	M	F	M	F	M	F	M	F		M	F	M	F	M	F			M	F	
Afghanistan	11	1	2		14		2		30	8		4		1		16	2(MBA) 1(MCA) 4(Diploma)			50
Nepal	1								1							0		1		2
Combdia																		1		1
Mauritius																			1	1
Usa									0							0		1		1
Japan									0							0			2	2
Sri Lanka	1								1	1						1				2
Myanmar																		1		1
El-Salvadore		1							1											1
Malawai																	1(B.TECH)			1
Tanzania										1						1				1
Yemen												1				1		1		2
Nigeria										1										1

TOTAL - 66

Afghanistan : B.A. -12, B.SC.-2, B.COM.-14, M.A.-8, M.SC.-4, M.B.A.-2, B.C.A.-2, M.COM.-1, M.C.A.- 1, DIPLOMA-4

Nepal : B.A. I-1/ Ph.D.-1

Combdia : Ph.D. – 1

Mauritius : Ph.D. – 1

USA : Ph.D. – 1

Japan : Ph.D. – 2

Srilanka : B.A.i-1, M.A.-1

Myanmar : Ph.D. – 1

EL-SALVADORE– B.A.-1

MALAWAI – B.TECH-1

TANZANIA – M.A.-1

YEMEN- M.SC.-1, PH.D.-1

NIGERIA- M.A.,-1

PROCTOR OFFICE

कर्तव्य निर्वहन

1. कुलानुशासक द्वारा 24X7 सुरक्षा हस्तु कन्द्रित सुरक्षा प्रकोष्ठ का गठन किया गया, जिसका अन्तर्गत विश्वविद्यालय परिसर एवं आस-पास का क्षेत्र में विश्वविद्यालय की गरिमा, अनुशासन एवं शान्ति-व्यवस्था बनायारखनामें सम्पूर्ण प्रयास किया गया, जिससाछात्र/छात्राएँ मित्रतापूर्ण वातावरण में रह सकें।
2. प्रवक्षा कार्य काबाद सभी कक्षाओं का लगभग 25000 (पचीस हजार) नियमित एवं भूतपूर्व छात्रों को नया परिचय-पत्र बनाकर प्रदान किया गया। सम्बन्धित प्रपत्र कम्प्यूटरीकृत एवं लिखित रूप साहै। 3. गत सत्र में लगभग 3250 छात्रों को चरित्र प्रमाण पत्र प्रदान किया गया।
4. विश्वविद्यालय द्वारा करायी जानलाली स्नातक/परास्नातक एवं अन्य सभी कक्षाओं में प्रवक्षा परीक्षाएँ एवं प्रवक्षा कार्य प्राक्टोरियल बोर्ड काव्यापक सहयोग सा शान्ति पूर्ण ङंग सासम्पन्न कराया गया।
5. विश्वविद्यालय की प्रत्यक्ष कक्षा की वार्षिक एवं समस्त मुख्य परीक्षाओं में परीक्षा कन्द्रों पर सघन जाँचोपरान्त प्रवक्षा करनादिया गया, जिसकाकारण प्रत्यक्ष परीक्षा शुचितापूर्ण ङंग सासम्पन्न हुई।
6. विश्वविद्यालय की होनलाली समस्त कक्षाओं की प्रवक्षा परीक्षाओं में समस्त परीक्षार्थियों कासघन जाँच करनाएवं जैमर लगाकर परीक्षाएँ सम्पादित करायी गयीं।
7. प्रवक्षा पानलालछात्रों को सुविधा दियाजानहस्तु कुलानुशासक द्वारा प्रवक्षा प्रकोष्ठ का गठन किया गया है।
8. सर्वोच्च न्यायालय कानिर्देशानुसार रैगिंग पर पूर्ण अंकुश लगाया गया:
 - (क) प्रत्यक्ष संकाय एवं छात्रावासों में एन्टी रैगिंग रोधक समितियाँ बनाई गई।
 - (ख) एन्टी रैगिंग रोधक समिति कासदस्यों का नाम एवं उनका मोबाइल नम्बर विश्वविद्यालय का प्रत्यक्ष विभागों एवं छात्रावासों में पोस्टर का माध्यम सा प्रषित की गयी।
9. छात्रसंघ चुनाव प्राक्टोरियल बोर्ड काव्यापक सहयोग सासम्पन्न हुआ। इस संदर्भ में यह भी सूचित हो कि मतदाता सूची बनानका कार्य प्राक्टर कार्यालय का द्वारा तैयार किया गया। छात्रसंघ चुनाव 2018-19 में लगभग 19031 वैध मतदाता थ।
10. कुलानुशासक कार्यालय द्वारा विशिष्ट रूप साछात्राओं की समस्याएँ सुननाएवं उनका निदान हस्तु एक विशिष्ट महिला प्रकोष्ठ का गठन किया गया है, जिसमें प्राक्टोरियल बोर्ड की महिला सदस्य सक्रिय रहती हैं, जो समय-समय पर अपनादायित्वों का पूर्ण निर्वहन करती हैं। प्राक्टोरियल बोर्ड में 2 महिला प्राध्यापकों को डिप्टी प्राक्टर नियुक्त किया गया है।
11. विश्वविद्यालय परिसर में होनलाली अराजकता पर पूर्ण अंकुश लगानहस्तु कुलानुशासक कार्यालय द्वारा लगभग 92 कारण बताओ नोटिस 14 निलम्बन, 02 निष्कासन एवं कर्नलगंज थाना में 82 प्राथमिकी दर्ज करवाई गई। इसी क्रम में छात्रावासों साअवैध कब्जा हटानहस्तु अवैध कब्जाधारियों का विरुद्ध कर्नलगंज थाना में एफ0आई0आर0 दर्ज करवाई गयी है।
12. पूर्व निलम्बित/निष्कासित छात्रों का प्रकरणों पर समितियों का गठन कर निर्णयोपरान्त निलम्बन/निष्कासन वापस किया गया। कुछ छात्रों का प्रकरण पर गठित जाँच समिति जाँच कर रही है।
13. माननीय उच्च न्यायालय का निर्णय/पारित आदक्षा संख्या 13688 वर्ष 2017, धर्मवीर सिंह बनाम इलाहाबाद विश्वविद्यालय व अन्य दिनांक 03.04.2017 का विरोध में छात्रावास में रहनलालअराजक तत्वों काद्वारा विश्वविद्यालय कासंकायों में आगजनी, तोड़फोड़ कर लगभग करोड़ों रूपयाक्षी सम्पत्तियों को नष्ट कर दिया गया, जिसमें चिन्हित छात्र तथा हजारों अजात छात्रों का विरुद्ध स्थानीय थाना में प्राथमिकी दर्ज करायी गयी। 14. माननीय उच्च न्यायालय का निर्णय/पारित आदक्षा संख्या 13688 वर्ष 2017, धर्मवीर सिंह बनाम इलाहाबाद विश्वविद्यालय व अन्य दिनांक 03.04.2017 का अनुपालन में विश्वविद्यालय का सभी छात्रावासों को रिक्त कराया गया। लगभग 20-25 वर्षों साअनधिकृत रूप साकाबिज अराजक तत्वों को जिला प्रशासन एवं कुलानुशासक की टीम ना छात्रावासों को खाली करवाया जो एक ऐतिहासिक कार्य हुआ।
15. विश्वविद्यालय प्रशासन का निर्णय/आदक्षानुसार छात्रों का वाहन निःशुल्क रखाजाता है। वाहनों की सुरक्षा हस्तु टोकन पर्ची साइकिल स्टैण्डों पर मुफ्त में प्रदान की जाती है, जिसका कोई भी शुल्क छात्रों साप्राप्त नहीं किया जाता है।

CENTRAL CULTURAL COMMITTEE

कन्द्रीय सांस्कृतिक समिति इलाहाबाद विश्वविद्यालय नग्नत वर्षों की भांति इस वर्ष भी परिसर में विभिन्न साहित्यिक, सांस्कृतिक व शैक्षणिक कार्यक्रम आयोजित किये। प्रमुख रूप से 15 अगस्त 2018 को स्वतंत्रता दिवस), 26 जनवरी 2019 (गणतंत्र दिवस) व स्थापना दिवस कार्यक्रम उत्साह एवं उल्लास पूर्वक मनाया, जिसमें बड़ी संख्या में छात्र-छात्राएं, अध्यापक, कर्मचारी-अधिकारी एवं शहर का गणमान्य नागरिकों की उपस्थिति रही तथा स्वतंत्रता दिवस एवं गणतंत्र दिवस का आयोजन में विशिष्ट सभा, शोध, शिक्षा-उपलब्धि, समाज-सद्भा आदि का लिया। विश्वविद्यालय का कर्मचारियों, अध्यापकों एवं शहर का विशिष्ट जनों को उत्कृष्टता पुरस्कार प्रदान किया गया। कुलपति द्वारा अभूतपूर्व रूप से कई वर्षों से विश्वविद्यालय का छात्रावासों में एवं विश्वविद्यालय का इर्दगिर्द चर्मशिल्प का कार्य कर रहा परश्रान जी को 26 जनवरी 2019 को ऐतिहासिक सीनर हाल में सम्मानित किया तथा 4 जनवरी 2019 को विश्वविद्यालय का वार्षिक कैलण्डर का विमोचन निर्धन रिक्शा चालक महाद्व जी साकराया, जो पिछले 40 सालों से इलाहाबाद शहर में रिक्शा चला रहे हैं। इसका अलावा सत्र में अनक विशिष्ट विद्वानों प्रो० शरद दशापांडे पद्मश्री अशोक भगत, स्वामी राम नरशाचार्य आदि का व्याख्यानों का भी आयोजन किया गया।



The Central Cultural Committee A.U organized Independence day 15th August 2018 Justice Agrawal, Prof. R.L Hangloo and members of Cultural Committee are in the Picture.

CENTRAL FACILITIES

CENTRAL LIBRARY

Introduction:

History: The Central Library has started its journey on the path of improvement. It was established to cater the needs of the students, research scholars, and teachers of the University. It not only helps in supporting the class room instructional programmes of the university, but also unfolds the horizon of knowledge with regard to the different research programmes carried out by the university.

The Central Library developed out of the library of the Muir Central College, Allahabad (established in 1872, and affiliated with the university from 1872 to 1922, when it was subsumed in the university upon beginning its career as a teaching university). Foundation stone of the university library building was laid by Sir John Hewett on 17th Jan.1910. The University Library was started in 1916. In 1946-47, Dr.S.R. Ranganathan, Father of Library Science in India, was invited to suggest ways and means of improving the library. He submitted the development plan in March 1947, which was published by the university in the same year. Its contents covered wide range of areas: such as new library building, manpower, finance and other relevant items. A special committee was constituted to review the library development plan submitted by Dr. Ranganathan. The committee pointed out that the central library building constructed in 1913-16 was inadequate. The most satisfactory thing would be to erect a new building designed in accordance with the modern library practice. It recommended the conversion of the Darbhanga Hall into a reading room for 500 under-graduates (250 on the ground floor and 250 on the first floor. A portion of the graduates reading room was to be divided into private cubicles for the use by serious students or research scholars. After some times it was felt that space in Darbhanga hall is inadequate to store the reading materials and provide library services.. The present library building was constructed in 1973. The present library building is more spacious and has potential for further expansion. The old library building is now occupied by the office of the Registrar, as well as Accounts and General section of the University.

Dewey Decimal Classification Scheme (DDC) and Anglo American Cataloguing Rules-2nd edition (AACR-2) are followed for the purpose of classifying and cataloguing the documents. LIBSYS-4, Library Management Software is being used for creation of database.

Collection: The Central Library has a collection of.
(As on 31/03/2019 Approx.)

Books & Bound Vols Journals	750983
Ph.D. Theses (Hard + Soft Copy)	19118
E-books	2564
Current Journals	268
On-Line Journals	21461+
Online Databases	14
Current Popular Magazines	34
Newspapers	22

Working Hours: Library is kept open from 8:00AM to 9:00 PM from Monday to Saturday and from 10:00 AM to 6:00 PM on Sundays and holidays except on Republic Day, Holi, Eid-ul-Fitr, Independence Day, Mahatma Gandhi's Birthday, Vijaya Dashami, Diwali and Christmas.

Membership: Library membership is open to the members of the University community (i.e. teachers, officers, research scholars, students and other employees of the university). Consultation facility is also provided to the teachers and research scholars of other universities and colleges, on production of proper identity /recommendations from concerned authority.

During the year 2018-19, the following activities were undertaken:

Subscription of Journals: The Library subscribed to 268 journals on behalf of various departments. Department wise breakup of these journal's titles is as under:

S. No	Name of Subject	No. of Journal	S.No	Name of Subject	No. of Journal
01	Ancient History	3	19	KBCAOS/MNSCOSS	5
02	Anthropology	8	20	Law	19
03	Arabic & Persian	9	21	Lib. & Inf Sc.	6
04	Biochemistry	1	22	Mathematics	5
05	Biotechnology	5	23	Med. & Mod. History	7
06	Botany	7	24	Music & Performing Art	4
07	Chemistry	8	25	Philosophy	3
08	Commerce & Business Administration	16	26	Physical Education	6
09	Defense Studies	2	27	Physics	8
10	Economics	11	28	Political Science	10
11	Education	4	29	Psychology	9
12	Electronics & Communication	8	30	Sanskrit	2
13	English	7	31	Sociology	5
14	Geography	4	32	Urdu	9
15	Geology (Earth & Pl. Sc)	7	33	Visual Art	2
16	Hindi	7	34	Zoology	5
17	Home Science	7	35	Globalization	2
18	Journalism & Mass Communication	3	36	Material Science	3

Out of these 229 titles, 137 are Indian and 92 are Foreign.

E-Resource Access: The Library provided access of approx.21461+ e-journals and 14 e-databases to its users. The access of these resources were provided through UGC-INFLIBNET Consortium i.e. e-Shodhsindhu, and subscription by the University

E-Resources through UGC-INFLIBNET Consortium (e-Shodhsindhu):

S.N.	Publisher	URL	No. of Journals
1	American Chemical Society Journals	http://www.pubs.acs.org	49
2	American Institute of Physics Journals	http://www.aip.org	19
3	American Physical Society Journals	http://www.aps.org	13
4	Annual Reviews	http://arjournals.annualreviews.org	43
5	Economic & Political Weekly	http://epw.in/	01
6	J-STOR Journals	http://www.jstor.org/	3164
7	Oxford University Press Journals	http://www.oxfordjournals.org	262
8	Springer Link Journals	http://www.link.springer.com	1438
9	Taylor & Francis Journals	http://www.tandfonline.com/	1079
10	Institute for Studies in Industrial Development (ISID) Database	http://isid.org.in/	Database
11	JGate Plus (JCCC)	http://jgateplus.com/search	Database
12	MathSciNet	http://www.ams.org/mathscinet	Database
13	Web of Science	http://www.webofknowledge.com	Database

E-Resources through Subscription:

1	IEEE ASPP/POP	http://www.ieee.org/ieeexplore	169
2	Scifinder Scholar (Chemical Abstracts Database)	https://scifinder.cas.org/scifinder/login?	Database
3	Sage Online Sociology Collection (April 2012 to March 2017)	http://online.sagepub.com	62
4	Taylor & Francis 43 Chemistry online Journal archives	www.tandfonline.com	43
5	Emerald Marketing Collection	http://www.emeraldinsight.com	21
6	Sage Online Research Methods Collection	http://online.sagepub.com	29

1	IEEE ASPP/POP	http://www.ieee.org/ieeexplore	169
7	SCOPUS	www.scopus.com	Database
8	Proquest Dissertation & theses full text database	http://search.proquest.com	Database
9	Manupatra Online Database	http://www.manupatra.com	Database
10	Economic Outlook of CMIE	http://www.cmie.com	Database
11	BCI-AIR (AIR Product)	http://airwebworld.com	Database
12	South Asia Archive	http://www.southasiaarchive.com	Database
13	English Historical Documents	http://www.englishhistoricaldocuments.com	Database
14	Westlaw India Online Legal database	http://login.westlawindia.com/maf/wlin/ext/app/tocectory?stnew=true&sttype=stemplate&sp=inaiup-1	Database
15	Indiastat	http://www.indiastat.com	Database
16	EBSCO Academic Ultimate Search	http://search.ebscohost.com	10,000+

User Services:

During this period Central Library provided different types of library services to its users. These may be summarized as:

- Reference
- OPAC
- Circulation
- Reading
- Lending to departmental libraries
- Photocopying
- Consultation
- Membership
- Book Reservation
- Inter Library Loan
- Internet facilities for on-line access of e-resources
- SDI and CAS
- Access of e-resources
- CD writer and print out facilities for downloaded data,
- Remote Access
- Plagiarism Detection

Outside Research Scholars/Teachers: During this period approx. 410 research scholars and teachers from various universities/instituted of the country such as : Shakuntala Mishra University, Lucknow, Nehru Gram Bharti University, Allahabad, Bihar Central University, Patna, Rajasthan Central University, Aligarh Muslim University, Aligarh, Banaras Hindu University, Varanasi, Lucknow University, Lucknow, Jammu University, Jammu, U.P.R.T.Open University, Allahabad, D.D. University, Gorakhpur, C.C.S. University Meerut, University of Delhi, Delhi, Jawahar Lal Nehru University, Delhi,V.B.S.Purvanchal University Jaunpur, RML Avadh University Faizabad, Mahatma Gandhi Kashi Vidyapeeth, Varanasi, B.R.A. University Agra, Rani Durgawati University, Jabalpur, A.P.S. University Rewa, CSJM University Kanpur, PG College Mirzapur, PG College Handia, Govt. College Gyanpur, DAV PG college Azamagarh, etc visited to consult the resources available in the Central Library, University of Allahabad for their research work.

User Awareness Programmes :- During the period, Central Library organized following two user awareness programmes –

- User Awareness Program on Publishing and Contents on 13.11.2018 for writing and publishing
- Launching of Remote access facility on 06.06. 2018 for access of e-resources available at University of Allahabad from anywhere anytime

Refresher Course

- Central Library with collaboration of UGC-HRDC organized a Refresher Course in Library Science on “Changing Role of Librarian in Access and Management of Resources of Libraries” from 1st December 2018 to 21st December 2018

ENGINEERING AND WORKS DEPARTMENT

Introduction

Dilapidated Tilak Bhawan was repaired & maintenance during the period. It will serve as mini auditorium for having seating capacity of 300 persons approximately.

Now Status



Conservation of Vizianagaram Hall & surrounding area.

Designed by Renowned architect Sir William Emerson, the building was completed in 1885 and inaugurated in 1886 by Lord Dufferin. Due to age effect the condition of the building deteriorated. The conservation process to restore the same was carried out during the period.

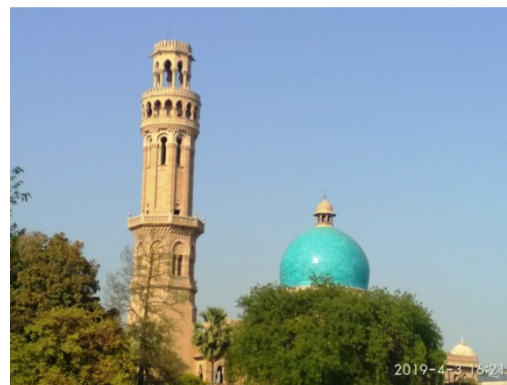

The University installed Solar panels for the capacity of 1.434 Mw during the period



Construction of 300 get capacity hostel was started during the period.



Construction of International Hostel was started during the period.

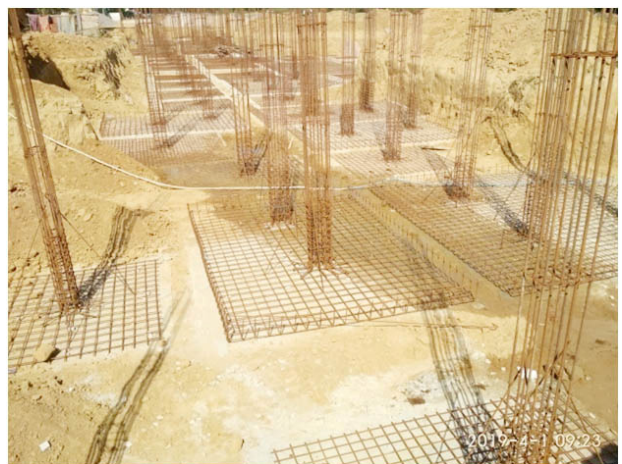

OTHER ACTIVITIES

UNIVERSITY INDUSTRY INTERFACE CELL (UIIC)

Rationale

The University Industry Interface Cell (UIIC) has been established in February 2014 after the initiative of Prof. A.K. Singh, Hon'ble Vice-Chancellor of University of Allahabad to facilitate the development of symbiotic relationships between the University and partners from different industrial sectors. It will act as a dynamic liaison unit with industry counterparts in order to identify opportunities to develop innovative solutions for technological and industrial problems in aid of national development.

Mission

The mission of the UIIC is to foster ties with industries through continual dialogue. This interface is envisioned to keep the University's research and academic programs responsive to industry needs and relevant to national development goals.

Objectives

- To strengthen University Industry linkage
- To provide venues for continual dialogue with various industrial sectors through symposia, exhibitions and roundtable discussions.
- To help identify relevant directions for the University's research thrusts and academic programs based on up-to-date feedback from industry partners.
- To maintain congenial relations with industry partners committed to supporting the University's industrial internship programs in the undergraduate and postgraduate levels.
- To identify opportunities for extending relations with industry through various activities, including commissioned research projects and topic-oriented technical seminars.

Benefits of University-Industry Linkage to the Industry

- Access to manpower, including well-trained graduates and knowledgeable faculty from the university;
- Access to basic and applied research results from which new products and processes will evolve;
- Solutions to specific problems or professional expertise, not usually found in an individual firm
- Access to university facilities, not available in the industry
- Assistance in continuing education and training
- Being good local citizens or fostering good community relations

Benefits of University-Industry Linkage to the University

- Industrially sponsored research provides student with exposure to real world research problems
- Industrially sponsored research provides university researchers a chance to work on an intellectually challenging research programs;
- Some government funds are available for applied research, based upon a joint effort between university and industry.
- Industry provides a new source of money for university

Activities during 2018-19

Mushroom Production Training Programme for Farmers

Prof. M.P. Singh, Coordinator, Centre of Biotechnology & Bioinformatics and Nodal Officer, UIIC organized Mushroom Production Training Programme for farmers on 31st January 2019. He along with his scholars provided training to farmers to grow mushroom which can be used as an effective weapon against malnutrition. Prof. Singh told farmers about low cost mushroom cultivation technology on locally available agrowastes to sort out both the problems of agro-wastes accumulation and malnutrition by producing cheaper protein on valueless agro-wastes. This low cost technology can motivate farmers and underprivileged people to go for startup industry. This will mitigate unemployment and improve socio-economic condition of uneducated, unskilled landless poor farmers. This technology can also be used for remediation of heavy metals and toxins from coal washery effluents as well as dye industries

UNIVERSITY PLACEMENT CELL (UPC)

Vision:

“The University Placement Cell, University of Allahabad envisions and strives to be the most preferred and one stop destination for prospective employers, looking for qualified and fresh human resource from different streams.”

Mission:

“Our mission is to work towards enhancing the employability of the students of the University through continuous personality development programmes, workshops and active engagement of all the stakeholders. Creating awareness and inclination towards recent and relevant internship and job prospects and to facilitate both on and off campus placement opportunities.”

Placement Officer: Shaswat, Model Career Centre, 3rd Floor, FCI Complex, University of Allahabad.

Workshops/Training Programs for the year 2018-19

S.No	Date	Workshop/Training Program	Target Audience	No. of Participants (approx)
1	21-08-2018	Special Counselling cum Guidance Program – DRDO Entry Test –2018: CEPTAM - 09/STA-B by Dr. Mohd. Arif, Scientist, (Additional Director) Retd. DRDO, Ministry of Defence, Govt. of India.	B.Sc. Students of Computer Science, Botany, Photography, Chemistry, Geology, Mathematics, Psychology, Physics, Zoology.	40
2	25-08-2018	Special Counselling cum Guidance Program – DRDO Entry Test –2018: CEPTAM - 09/STA-B by Dr. Mohd. Arif, Scientist, (Additional Director) Retd. DRDO, Ministry of Defence, Govt. of India.	B.Sc. Students of Computer Science, Botany, Photography, Chemistry, Geology, Mathematics, Psychology, Physics, Zoology.	10
3	06-09-2018	Career Guidance & Counselling Session	Students of CMP College	110
4	13-09-2018	Career Talk	UG, PG & research scholars of Dept. of Geography.	500
5	14-09-2018	Campus to Corporate	MBA final year students of Monirba	25
6	17-09-2018	Campus to Corporate	MBA (Rural Development) of GBPSSI	40
7	19-09-2018	Campus to Corporate	Students of SS Khanna Girls College	120
8	27-10-2018	Campus to Corporate	MCA students	25
9	15-11-2018	Campus to Corporate	Final year M.Sc. (Applied Geology)	15
10	20-11-2018	Campus to Corporate	M.Com students	44
11	29-11-2018	How to Face an interview & Resume Preparation	Final year M.Sc. students of Environmental Science & Applied Geology	25
12	21-12-2018	How to Face an interview & Resume Preparation	Final Year M.Sc. (Chemistry)	25
13	16-01-2019	How to face an Interview	Shortlisted students for APF Interviews.	30
14	15-02-2019	Emerging Trends in Logistics & Supply Chain – Analytical Perspective by Mr. Mohit Gauba, Supply Chain Expert and CEO SCM Connect, New Delhi.	PG Students of Commerce, Management, Economics and Statistics	36
15	06-03-2019	Career Talk cum motivational session on joining “Indian Army as an Officer – through multiple entries and at different stages of student life” by Capt Tushar Yadav, 314 Medium Regiment, Prayagraj.	Final & pre-final year students of B.A., B.Sc. and B.Com.	50
16	25-03-2019	Career Guidance & Counselling Session	NCC cadets	25
Total				1120

Campus Drives as for the year 2018-19

S. No	Date	Drive	Number of Participations	Selections/Remarks
1	04-09-2018	Azim Premji Foundation - For Ph.D. Scholars of History English, Hindi, Geography, Political Science, Physics, Chemistry, Mathematics, Geology, Zoology, Botany, Bio-Chemistry.	20	Sh. Upendra Bahadur Singh, Ph.D. Physics have been selected and have joined the Foundation. Final round of interview pending for one more Research Scholar from Political Science, to be scheduled in April, 2019.
2	23-11-2018	Azim Premji Foundation - For P.G. Students of Hindi, English, History, Political Science, Geography, Physics, Chemistry and Maths.	180	Sh. Lavkush Yadav, M.A. (Hindi)
3	10-01-2019	Piramal Foundation (Gandhi Fellowship) for final year UG & PG students from all streams.	32	Results of final round of interviews awaited for 22 students.
4	11-01-2019	Prism Johnson Limited (Prism Cement) for Final year M.Sc. students of Chemistry and Environmental Science.	30	Sh. Shakti Singh, M.Sc. (Chemistry) and Sh. Shubham Gupta, M.Sc. (Chemistry).

Qualitative Aspects of Placement Activities for 2018-19

- Academic Year 2018-19 is the second year of operation of the Placement Cell.
- Initiated and organized Career Talk cum Informative sessions by retired senior official from DRDO, Industry Expert from Supply Chain & Logistics sector and from the Indian Army. Many more such events are planned for establishing excellent Industry-Academia relationships and promotion of career avenues in Emerging Sectors, sensitization towards national & international Fellowships.
- Established mechanism of capturing feedback cum evaluation forms post workshops from the participants besides proper data base management of the participants.
- January & February season of placements impacted due to limited number of working days and logistical constraints arising out of Kumbh Mela. Postponement/cancellation of Drives by TCS, Wipro etc.
- Upcoming drives in April, 2019: Azim Premji Schools and Wipro Ltd.
-



Participants in the APF Campus Drive on 04-09-2018



Participants of the Campus Drive - APF 23-11-2018



Participants of the Group Discussion round for Piramal Foundation held on 10-01-2019



Senior officials from Prism Cement



Students participating in the Prism Cement Campus Drive held on 11-01-2019



Students participating in Workshops and Informative Sessions



UGC HUMAN RESOURCE DEVELOPMENT CENTRE

Introduction:

The main aim of the Human Resource Development Centre (HRDC) has been to facilitate quality education by upgrading the knowledge and performance of teachers serving in Universities and their affiliated Colleges. By organizing the abovementioned programmes, the Staff College has given the teachers, the opportunity to come to a platform where interactions with eminent resource persons and with other teacher participants were possible. The programmes covering a wide spectrum of subjects have provided the crucial link between motivation of teachers for creative and innovative teaching and research, commitment towards their profession, academic leadership and quality education. Some of the approaches undertaken by this HRDC to fulfill its aims to enhance the personality, performance, awareness and knowledge of the teacher participants include-

- Invocation of basic thoughts on being a good teacher - Values, Character, Commitment, Team Building, Work Culture, Human Resource Development and Academic Leadership qualities required in teachers for Societal Transformation,
- Creating Computer Awareness and in this way developing IT trained human Capital for quality education of the future generation, Power point Presentation, LCD and OHP usage
- Revitalizing inputs for Higher education through Teacher empowerment, Inter-disciplinary dialogues, open and flexible Trans-disciplinary subjects, Innovative teaching Methodologies, Collaboration with Academic, Research and Specialized Institutes
- Creating awareness about the higher education System, Rules, Regulations, Statutes and Policies, Motivation for Research, Project Writing, Funding Agencies and Avenues
- Weaving Gender Justice and Gender Equality in the system through lectures/ workshops/seminars on Capacity Building, Gender Sensitization and Gender awareness
- Stressing the importance of mental and physical health by lectures and demonstrations by Yoga Experts and practice sessions by the teacher participants. This has become an integral part of all Orientation Programmes
- Organizing programmes and activities related to Social and Communal Harmony, Secularism and National Integrity such as lectures and Literary programmes, Essay Writing Competitions, Cultural Evenings, Group Discussions and Seminars
- Inviting eminent Resource Persons and Subject Experts for both OPs and RCs and giving teachers the opportunity to interact with them.

“NAAC” review of Human Resource Development Centre took place from February 27 -29, 2012 under the chairmanship of Prof. Sunil Gupta, the former Vice Chancellor of H P University, Shimla. Human Resource Development Centre is determined to work in accordance to recommendations given by the NAAC Peer Team and Academic Advisory Committee under the chairmanship of Hon’ble Vice Chancellor Prof. A K Singh.

During the session 2018-2019, for which the report is being submitted, the UGC-HRDC has successfully completed most of the programmes allocated by the UGC for the session. It has organized 4 out of 4 Orientation Programmes with 197 participants and 08 out of 09 Refresher Courses (Including Summer and Teacher Educators programme) with 302 participants. Besides the subject Refresher Courses conducted by the concerned department, 3 Interdisciplinary Refresher Courses were organized successfully by the HRDC. This included 1 ID in Human Rights, 1 ID in Media Studies and Governance and 1 Special Summer School in Social Science. It is my pleasure to report here that this HRDC has been ranked amongst the first ten HRDCs of the country based on the OPs and the RCs conducted by the HRDCs. (Detail attached Session 2018-2019)

The UGC-HRDC, University of Allahabad has like in the previous sessions contributed efficiently towards sustaining quality in HE which is the basis of socio-cultural, economic and scientific development of a nation by

- continuous improvement of processes, products and services through well defined, well planned and well managed programs
- Implementation of technology rich approach in accelerating the transfer of knowledge to the diversified population of students in terms of age, gender, ethno-religious background and socio-economic profile

- Developing a sound and value-based education system and motivating teachers for creative and innovative teaching and research
- Invocation of basic thoughts on being a good teacher - qualities, character, commitment and academic leadership required in the teachers for societal transformation
- Development of IT trained human capital required for quality education which is at the crossroads of finding directions for future generations, characterized by the Information & Communication revolutions
- revitalizing inputs through teacher empowerment, inter-disciplinary dialogues and open and flexible trans- and multidisciplinary subjects
- Designing a regular feedback mechanism from the resource persons and participants for upgrading our programmes to fulfil our goals
- Innovative teaching methodologies, interactive sessions, group discussions, capacity building programmes and essay writing competitions

Apart from the regular lectures and interactive sessions with the Resource Persons and the participants, the HRDC has also conducted:

- Workshops/seminars/group discussions/ essay writing competitions on topics related to **Mental and physical health** ‘Mental Health and Attitudes’, ‘Yoga and Meditation’, ‘Overcoming Mental Stress’, ‘Yoga and Mental Health’, ‘Naturopathy - living without medicines’, ‘AIDS Awareness’ **value education** ‘Shiksha men Mulyon ki Anivarta’; **current topics** ‘Atankvad’, **communal harmony** ‘Sampradayik Sadbhavna mein Adhyapak ki bhumika’,
- Programs under ‘**Know your Country India**’ which include visits to archeological museums, excavation, cultural and heritage sites and historical monuments
- Visits to specialized institutes, libraries and participation in related national and international seminar/symposium being organized during the duration of the programme in the university
- Programs and activities to promote Social Cohesion, Communal Harmony, Secularism and National Integration

Staff Appointed in HRDC

Name & Designation	Qualifications	Date of appointment	Whether permanent or on deputation
Prof. R K Singh, Director	M.A. (English), Ph.D.	26.02.2016	Addl. charge
Sri Sanjeev Gaur, Office Assistant	Intermediate	01.04.1991	Permanent
Sri T N Choudhry, Technician–cum-Library Assisatnt	Graduation, Diploma in Library Sc.	01.04.1991	Permanent
Mrs. Nirmal Agrawal, Office Assistant	PG	10.02.2015	Permanent

Orientation Programme(s) (4 Weeks – 24 Working Days)

S. No.	Orientation Programme		Gen		OBC		SC		ST		Total
	Course Allotted by UGC	Course Conducted (to be Conducted) by ASC, Allahabad University	M	F	M	F	M	F	M	F	
1.	4 OP (G)	120th Orientation Programme (25.07.2018 to 21.08.2018)	11	09	07	01	03	01	-	-	32
		121st Orientation Programme (19.09.2018 TO 16.10.2018)	18	07	10	03	01	02	--	--	41
		122nd Orientation Programme (04.01.2019 to 31.01.2019)	13	15	12	01	-	01	01	-	43
		123rd Orientation Programme (14.02.2019 to 13.03.2019)	33	21	19	02	03	02	01	-	81
		Total	75	52	48	07	07	06	02	-	197

Refresher Course(s) (3 Weeks – 21 Working Days)

S. No.	Refresher Course Programme(s) /Courses		Gen		OBC		SC		ST		Total
	Course Allotted by UGC	Course Conducted (to be Conducted) by ASC, Allahabad University	M	F	M	F	M	F	M	F	
Subject Refresher Course											
1.	English	English (04.12.2018 to 24.12.2018)	09	12	05	01	03	02	01	-	33
2.	Library Science	Library Science (01.12.2018 to 21.12.2018)	24	10	11	01	03	-	-	02	51
3.	Visual and Performing Arts	Visual and Performing Arts (24.08.2018 to 13.09.2018)	08	10	06	01	03	01	02	-	31
4.	Physics	Physics (12.11.2018 to 02.12.2018)	13	03	07	01	02	02	01	-	29
5.	Teachers Educators	Teachers Educators (21.02.2019 to 13.03.2019)	12	08	02	03	03	01	-	-	29
INTERDISCIPLINARY REFRESHER COURSE											
6.	Human Rights	Human Rights (10.11.2018 to 30.11.2018)	17	10	14	07	07	02	-	-	57
7.	Media Studies & Governance	Media Studies & Governance (07.03.2019 to 27.03.2019)	10	06	08	04	03	-	-	-	31
8.	Summer School in Social Sciences	Summer School in Social Sciences (21.06.2018 to 11.07.2018)	16	16	07	--	--	02	--	--	41
9.	Winter School in Nano-Science and Technology	Winter School in Nano-Science and Technology (30.11.2018 to 20.12.2018)	--	---	---	---	---	---	---	---	--
			109	75	60	18	24	10	4	2	302

OFFICE OF ACADEMIC PROGRAMMES

The office of the Professor In-charge Academic Programmes has been in the vanguard of the development activities of the university in the year under review as well. Keeping the momentum gained in the preceding years going, it lent support in speedy disposal of academic and other related matters through the committees constituted by the order of the Vice Chancellor. The major tasks entrusted were handled successfully and capped effectively are as follows:

1. As Coordinator, organised courses in various university departments by foreign expert under the auspices of MHRD sponsored scheme called Global Initiatives for Academic Network (GIAN)
2. Acted as Chairman of admissions of the courses of study of the university and completed entire
3. admission process for academic programmes on time. Introduced online component successfully for several courses
4. Acted as Chairman of the Advisory Committee of the AU Students' Union. Oversaw the smooth conduct of elections free from violence and ensuring compliance with the Lyngdoh Committee Recommendations
5. End to end processing of NIT for deployment of Security Agency and present before the Vice Chancellor for award
6. Processing of limited tenders for award of contract to operate canteen and mess in the campuses and hostels for welfare of students
7. Committee to prepare a report relating to academic, research, financial and infrastructural audit of the university (work in progress)
8. Governance of Ewing Christian College in the capacity of Special Officer on Duty. Ensuring effective academic, administrative and financial functioning of the College in the wake of the suspension of the College Managing Committee on charges of having indulged in gross mismanagement.
9. Chairman of the high Power Committee to make recommendations in respect of the management of the hostels owned by the trusts recognized by the university.

In addition to the above several other committees to inquire into the affairs involving students' indiscipline and hostel mismanagement were constituted under the chairmanship of Professor Incharge, Academic Programmes.

The office was also assigned the onerous task of holding Allahabad University Students' Union (AUSU) election for 2018 as the Chairman of the Students' Advisory. Traditionally considered to be a highly surcharged and sensitive event, efforts were successfully done to keep the entire election process peaceful and free from controversy.

The office also adroitly and successfully discharged its mandate to accomplish tasks under the ongoing projects of MHRD, GIAN Phase II and as a Spoke Partner with BHU-IIT as Hub for Design & Innovation Project (DIC), both schemes launched by Government of India.

RAJBHASHA CELL

राजभाषा अनुभाग

परिचय :

संविधान के अनुच्छेद 343 के अंतर्गत हिंदी हमारी राजभाषा है। केन्द्र सरकार के प्रत्येक कार्यालय में हिंदी के प्रचार-प्रसार एवं प्रगामी प्रयोग के लिए राजभाषा अनुभाग/प्रकोष्ठ के गठन का प्रावधान है। केन्द्र सरकार के दिशा निर्देशों के अनुसार कार्यालयीन कार्य हिंदी में करना हमारी विधिक जिम्मेदारी भी है। इन्हीं प्रावधानों के अनुपालन में इलाहाबाद विश्वविद्यालय में राजभाषा अनुभाग/प्रकोष्ठ का गठन वर्ष 2011 में किया गया।

राजभाषा अनुभाग/प्रकोष्ठ राजभाषा अधिनियम 1963 एवं राजभाषा नियम 1976 के अनुपालन के साथ-साथ मंत्रालय द्वारा प्राप्त विभिन्न निर्देशों के अनुपालन सुनिश्चित करने का कार्य अपनी स्थापना के बाद लगातार कर रहा है।

वर्तमान में प्रो. संतोष भदौरिया, प्रोफेसर (हिंदी) के संयोजन में राजभाषा अनुभाग हिंदी का प्रचार-प्रसार का कार्य कर रहा है। श्री हरिओम कुमार, हिंदी अनुवादक/प्रभारी अनुभाग के स्थायी कर्मचारी हैं

महत्वपूर्ण क्षेत्र:

राजभाषा हिंदी का प्रचार-प्रसार प्रोत्साहन के माध्यम से करना। केन्द्र सरकार की राजभाषा नीति का कार्यान्वयन करना। समय-समय पर राजभाषा नीति संबंधी आदेशों का अनुपालन सुनिश्चित करना साथ ही अधिकारी/कर्मचारियों/छात्र/छात्राओं के लिए कार्यशालाएं/संगोष्ठियां आयोजित करना। इसके अतिरिक्त मंत्रालय के राजभाषा हिंदी से संबंधित नियम एवं वार्षिक कार्यक्रम का अनुपालन विश्वविद्यालय में सुनिश्चित करना।

सहयोगी स्टाफ

क्र.स.	नाम	लिंग	पदनाम
1.	प्रो. संतोष भदौरिया	पुरुष	आचार्य(हिंदी)/ संयोजक, राजभाषा कार्यान्वयन समिति, इ.वि.वि.
2.	श्री हरिओम कुमार	पुरुष	प्रभारी/ हिंदी अनुवादक

अनुभाग की विभिन्न समितियां :

राजभाषा कार्यान्वयन समिति इ.वि.वि.

राजभाषा हिंदी प्रचार- प्रसार का लिए उच्च समिति का गठन किया गया है। इस समिति का संरक्षक माननीय कुलपति महोदय, इ.वि.वि. एवं अध्यक्ष पदेन कुलसचिव होते हैं। वर्तमान में प्रो. नरेन्द्र कुमार शुक्ल (कुलसचिव) समिति के अध्यक्ष हैं तथा प्रो. संतोष भदौरिया (आचार्य हिंदी) समिति के संयोजक हैं साथ ही इ.वि.वि. एवं संघटक महाविद्यालयों के शिक्षक एवं कर्मचारी इस समिति के सदस्य हैं।

निरीक्षण समिति :- इ.वि.वि. में राजभाषा हिंदी का कार्य का निरीक्षण उक्त समिति करती है।

राजभाषा पखवाड़ा, 2018 का आयोजन

14 सितंबर, हिंदी दिवस के अवसर पर इलाहाबाद विश्वविद्यालय के समस्त शिक्षकों/अधिकारियों/कर्मचारियों एवं छात्र/छात्राओं हेतु विभिन्न प्रतियोगिताओं का आयोजन किया गया। प्रत्येक प्रतियोगिता में प्रथम, द्वितीय, तृतीय एवं सात्वना पुरस्कार रखे गए। इन पुरस्कारों में प्रमाणपत्र एवं पुरस्कार राशि विजेताओं को प्रदान की गई। इन प्रतियोगिताओं में समस्त कर्मचारियों एवं इ.वि. वि. एवं संघटक महाविद्यालयों के छात्र/छात्राओं ने बढ-चढ कर हिस्सा लिया। इ.वि. वि. के अधिकारियों/कर्मचारियों ने अपने व्यस्त कार्यालयीन कार्य से इन प्रतियोगिताओं के लिए समय निकाल कर राजभाषा की प्रतियोगिताओं में भाग लिया। सभी प्रतियोगिताएं ऐसे तो एक दूसरे से बिलकुल अलग थीं किंतु प्रेरक प्रसंग एवं कार्यालयीन पत्र लेखन प्रतियोगिताओं को अत्यधिक पसंद किया गया। इसी क्रम में गीत/काव्य पाठ प्रतियोगिता में प्रतिभागियों ने अपनी एवं अन्य रचनाकारों की कविताओं का पाठ अपनी- अपनी शैली में किया। इन समस्त प्रतियोगिताओं में निर्णायक मंडल की भूमिका का निर्वहन डॉ. आशा उपाध्याय, डॉ. दीनाथ, प्रो. योगेन्द्र प्रताप सिंह, प्रो. चंदा देवी, प्रो. लालसा यादव, प्रो. मुस्ताक अली आदि द्वारा किया गया।

राजभाषा पखवाड़े के दौरान आयोजित प्रतियोगिताएं

दिनांक	प्रतियोगिताएं	प्रतिभागिता
17.09.2018	सुलेख प्रतियोगिता	इ. वि.वि. शिक्षक/ अधिकारी/कर्मचारी
17.09.2018	सुलेख प्रतियोगिता (MTS)	इ. वि.वि.के MTS कर्मचारी
18.09.2018	कार्यालयीन पत्र लेखन प्रतियोगिता	इ. वि.वि. शिक्षक/ अधिकारी/कर्मचारी
18.09.2018	निबंध लेखन प्रतियोगिता	छात्र/छात्राएं
19.09.2018	वाद-विवाद प्रतियोगिता	अंतर महाविद्यालयी
19.09.2018	वाद-विवाद प्रतियोगिता	अंतर विभागीय, इ.वि.वि.
14-27. 09.2018	स्लोगन लेखन प्रतियोगिता	इ.वि.वि. एवं संघटक कालेज
20.09.2018	प्रेरक प्रसंग प्रतियोगिता	इ. वि.वि. शिक्षक/ अधिकारी/कर्मचारी
24.09.2018	गीत/काव्य पाठ प्रतियोगिता	इ. वि.वि. शिक्षक/ अधिकारी/कर्मचारी
24.09.2018	गीत/काव्य पाठ प्रतियोगिता	इ.वि.वि. के समस्त छात्र/छात्राएं
24.09.2018	गीत/काव्य पाठ प्रतियोगिता	संघटक महाविद्यालय के छात्र/छात्राएं
11.10.2018	पारितोषिक वितरण	-



राजभाषा पखवाड़ा, 2018 के उदघाटन करते माननीय कुलपति महोदय, इ.वि.वि., न्यायमूर्ति अरूण टंडन (से.नि.) एवं प्रो. संतोष भदौरिया (संयोजक राजभाषा)।



“हिंदी दिवस, 2018” के अवसर पर मंच पर माननीय कुलपति इ.वि.वि. प्रो. आर. एल. हागलू, न्यायमूर्ति अरूण टंडन (से.नि.) एवं प्रो. संतोष भदौरिया।



हिंदी दिवस, समारोह में कुलगीत एवं सरस्वती वंदना प्रस्तुत करते संगीत विभाग के छात्र/छात्राएं।



हिंदी दिवस, समारोह के अवसर पर इ.वि.वि. के शिक्षक/अधिकारी/कर्मचारी/छात्र/छात्राएं।



राजभाषा पखवाड़ा, 2018 के अवसर पर आयोजित विभिन्न प्रतियोगिताओं के विजेता प्रतिभागी प्रमाण पत्र एवं नकद पुरस्कार प्राप्त करते हुए।



विशिष्ट कार्य/उपलब्धि

समीक्षा बैठक: 27-28 जून, 2018 को विश्वविद्यालय अनुदान आयोग की राजभाषा निरीक्षण समिति ने इलाहाबाद विश्वविद्यालय का राजभाषा निरीक्षण किया। निरीक्षण समिति में डॉ. (श्रीमती) उर्मिला देवी, संयुक्त सचिव (वि.अनु.आयोग) एवं डॉ. महेन्द्र कुमार, अवर सचिव (वि.अनु.आयोग) ने इ.वि.वि. का निरीक्षण किया। दिनांक 26.06.2018 को नार्थ हॉल में सभी विभागाध्यक्ष की एक बैठक माननीय कुलपति महोदय की अध्यक्षता में आयोजित की गई। इलाहाबाद विश्वविद्यालय में राजभाषा हिंदी में हो रहे कामों की समीक्षा की गई। राजभाषाई कार्य के संबंध में एक विस्तृत पावर पॉइंट प्रजेंटेशन राजभाषा अनुभाग के हिंदी अनुवादक ने दिया। सभी विभागाध्यक्षों से राजभाषा संबंधी कार्यों की बात करने के उपरांत संयुक्त सचिव महोदय ने निरीक्षण प्रश्नावली की समीक्षा की। इस निरीक्षण रिपोर्ट में संबंधित कमियों से सभी को अवगत कराया एवं अगले वर्ष निरीक्षण से पहले उक्त को सही करने का निर्देश दिया।

राजभाषा की वर्ष 2018 की डायरी का विमोचन: राजभाषा अनुभाग, इ.वि.वि. की वर्ष 2018 की वार्षिक डायरी का विमोचन 27 जून, 2018 को समीक्षा बैठक में निरीक्षण समिति द्वारा किया गया। उक्त डायरी में विश्वविद्यालय के महत्वपूर्ण संपर्क सूत्र एवं राजभाषा अधिनियम 1963 एवं राजभाषा नियम 1976 की जानकारी

भी प्रदान की गई। उक्त डायरी का वितरण इलाहाबाद विश्वविद्यालय के विभागों एवं संघटक महाविद्यालयों में किया गया।

कंप्यूटर पर हिंदी में काम करने के लिए बेसिक प्रशिक्षण कार्यक्रम: केंद्रीय हिंदी प्रशिक्षण संस्थान, राजभाषा विभाग, गृह मंत्रालय, भारत सरकार के तत्वावधान में आयोजित 5 दिवसीय बेसिक प्रशिक्षण कार्यक्रम में इलाहाबाद विश्वविद्यालय के दो कर्मचारी सर्वश्री संजय तिवारी एवं सुकेश कुमार त्रिपाठी ने प्रतिभागिता की।

अखिल भारतीय संगोष्ठी में प्रतिभागिता: वित्तीय वर्ष 2018-19 के मानव संसाधन विकास मंत्रालय, भारत सरकार के तत्वावधान में पोर्ट ब्लेलेयर में आयोजित दो दिवसीय अखिल भारतीय राजभाषा संगोष्ठी में राजभाषा अनुभाग, इ.वि.वि. से श्री हरिओम कुमार, हिंदी अनुवादक द्वारा प्रतिभागिता की गई।

सांस्कृतिक गतिविधियां: इलाहाबाद विश्वविद्यालय का सांस्कृतिक गतिविधियों का गौरवपूर्ण इतिहास रहा है। इसी क्रम को राजभाषा अनुभाग ने दोहराया। राजभाषा पखवाड़ा, 2018 के समापन सत्र के अवसर पर कथा सम्राट मुंशी प्रेमचंद की छः कहानियों का मंचन संघटक महाविद्यालयों एवं इलाहाबाद विश्वविद्यालय के विभागों ने किया।

सांस्कृतिक गतिविधियां:



“बड़े भाई साहब” कहानी का मंचन करते फिल्म एंड थियेटर विभाग के छात्र/छात्राएं।



“नशा” कहानी का मंचन करते ईश्वर शरण डिग्री कालेज, इ.वि.वि. के छात्र/छात्राएं।



“सद्गति” कहानी का मंचन करते जगत तारन गर्ल्स डिग्री कालेज, के छात्र/छात्राएं।



“निमंत्रण” कहानी का मंचन करते आर्य कन्या डिग्री कालेज, के छात्र/छात्राएं।



“बूढ़ी काकी” कहानी का मंचन करते एस.एस.के. स्नातकोत्तर महिला महाविद्यालय, इ.वि.वि. के छात्र/छात्राएं।



“ठाठारू का कुंआ” कहानी का मंचन करते के.पी.ट्रेनिंग कालेज, इ.वि.वि. के छात्र/छात्राएं।



मुंशी प्रेमचंद की छः कहानियों का मंचन करने वाले इ.वि.वि. एवं संघटक महाविद्यालयों के छात्र/छात्राएं।

गृह पत्रिका "संकल्पना" का विमोचन

राजभाषा अनुभाग, इ.वि.वि. की गृह पत्रिका "संकल्पना" का विमोचन राजभाषा पखवाड़ा, 2018 के समापन समारोह में किया गया।

विश्व हिंदी दिवस, 2019

10 जनवरी, 2019 विश्व हिंदी दिवस के अवसर पर नार्थ हॉल में एकदिवसीय संगोष्ठी का आयोजन किया गया। प्रथम सत्र का विषय था "गांधी और हिंदी" एवं द्वितीय सत्र का विषय था "हिंदी का वैश्विक परिप्रेक्ष्य"। मुख्य वक्ताओं के रूप में तिलका मांझी विश्वविद्यालय, भागलपुर से प्रो. श्रीभगवान सिंह (विख्यात गांधीवादी विचारक) एवं गोविंद वल्लभ पंत, इलाहाबाद के निदेशक प्रो. बद्रीनारायण जी को आमंत्रित किया गया। अन्य वक्ताओं में प्रो. राजेन्द्र कुमार, पूर्व विभागाध्यक्ष -हिंदी, प्रो. योगेन्द्र प्रताप सिंह (हिंदी विभाग), डॉ. सूर्यनारायण सिंह (एसो. प्रोफेसर-हिंदी), डॉ. अभितेश कुमार (असि. प्रोफेसर-हिंदी) आदि रहे। इस कार्यक्रम की अध्यक्षता माननीय कुलपति, इ.वि.वि. प्रो. रतनलाल हांगलू ने की। इस अवसर पर विश्वविद्यालय के वार्षिक कलेंडर का विमोचन माननीय कुलपति महोदय ने एक रिक्सा चालक के हाथों करवाया और एक मिशाल कायम की।



राजभाषा पखवाड़ा, 2018 के समापन अवसर पर गृह पत्रिका "संकल्पना" का विमोचन



विश्व हिंदी दिवस के अवसर पर आयोजित संगोष्ठी में माननीय कुलपति महोदय



विश्व हिंदी दिवस के अवसर पर आयोजित संगोष्ठी के अवसर पर प्रो. एन. के. शुक्ल (कुलसचिव, इ.वि.वि.), प्रो. बद्रीनारायण (निदेशक- पंत संस्थान), प्रो. श्रीभगवान सिंह, तिलका मांझी वि.वि., भागलपुर एवं प्रो. संतोष भदौरिया, हिंदी विभाग, इ.वि.वि.



विश्व हिंदी दिवस के अवसर पर विश्वविद्यालय के वार्षिक कलेंडर का लोकार्पण एक रिक्सा चालक से कराते माननीय कुलपति इ.वि.वि.।

21 फरवरी, 2019, अंतरराष्ट्रीय मातृभाषा दिवस

21 फरवरी, 2019 अंतरराष्ट्रीय मातृभाषा दिवस के अवसर पर संगोष्ठी एवं नाट्य मंचन का आयोजन नार्थ हॉल एवं सीनेट हॉल में किया गया। प्रथम सत्र संगोष्ठी का रहा जिसका मुख्य विषय था "मातृभाषा और रचनात्मक लेखन"। मुख्य अतिथि के रूप में वरि. कवि श्री नरेश सक्सेना जी एवं मुख्य वक्ता के रूप में वरि. कहानीकार शिवमूर्ति जी को आमंत्रित किया गया। उक्त संगोष्ठी की खास बात यह रही कि प्रथम सत्र के बाद "यूनिवर्सिटी थियेटर" ने वरि. कहानीकार श्री शिवमूर्ति जी की कहानी सिरी उपमा जोग एवं हरिशंकर जी के हास्य व्यंग "भोलाराम का जीव" कहानी का मंचन सामित साधनों से एतिहासिक सीनेट हॉल में किया। श्री शिवमूर्ति जी अपनी कहानी सिरी उपमा जोग कहानी के प्रथम मंचन के स्वयं साक्षी बने।



विश्व हिंदी दिवस के अवसर पर आयोजित संगोष्ठी के अवसर पर शिक्षक/कर्मचारी एवं छात्र/छात्राएं।



"मातृभाषा और रचनात्मक लेखन" पर आयोजित संगोष्ठी के अवसर पर श्री नरेश सक्सेना (वरि. कवि), श्री शिवमूर्ति (वरि. कथाकार), डॉ. भूरेलाल (हिंदी विभाग) एवं प्रो. संतोष भदौरिया(संयोजक-राजभाषा)।



श्री शिवमूर्ति कृत एवं डॉ. अमितेश कुमार एवं डॉ. लक्ष्मण प्रसाद गुप्ता द्वारा निर्देशित कहानी "सिरी उपमा जोग" का मंचन करते "यूनिवर्सिटी थियेटर" के छात्र/छात्राएं।



हरिशंकर परसाई कृत एवं डॉ. अमितेश कुमार एवं डॉ. लक्ष्मण प्रसाद गुप्ता द्वारा निर्देशित कहानी "भोलाराम का जीव"का मंचन करते "यूनिवर्सिटी थियेटर" के छात्र/छात्राएं।



"अंतरराष्ट्रीय मातृभाषा दिवस"का आयोजन एवं प्रमाणपत्र वितरण।

RESEARCH PUBLICATIONS OF THE FACULTY

DEPARTMENT OF ANCIENT HISTORY, CULTURE & ARCHAEOLOGY

- Ojha, A.P. Ojha , “Socio-Economic Contents of Jain Inscriptions during Gupta Period” presented in National Seminar entitled Jain Inscriptions organized by Parshwanath Jain Institute, Varanasi, 16-17 April, 2018
- Ojha, A.P. Ojha , “Social Stratifications in Ancient India: Ritualistic Vis-à-vis Actualistic Dimensions during Gupta Period”. Presented as Presidential Address, Section-1, Ancient India, U.P. History Congress, Lucknow Dr. Shakuntala Mishra Rehabilitation University, Lucknow, 17-18 November, 2018.

DEPARTMENT OF ARABIC AND PERSIAN

- Rasheed, S.(2018). *Bostane Khayal*, New Delhi, Arshiya Publication
- Rasheed, S.(2018). *Aslam Jamshedpuri: Urdu Afsane ki Ek Munfarid Aawaz*, New Delhi, Arshiya Publication
- Safi, S.(2018). *Aahang*, New Delhi, Alhuda Publication
- Ziyauddin, M.(2018). *Waseela*, New Delhi, Alhuda Publication
- Mirza, M. H. A. R. (2018). *The Role of Muslims in the Indian Freedom Struggle*, Azamgarh, Mirza Publications
- Rasheed S. (2019) Quran Aur Fanne Khattati, Quarterly Al Kash Shaaf Research Journal, Allahabad, Vol. 3, Issue no ; 1, January to March, 2019.
- Rasheed, S. (2018). Baba tahir Uryan ki Dobaitiyaan aur unka Urdu Tarjumah. In: Do Baitihaye Baba Tahir Uryan Hamadani (edited by Jahan, T.) pp 11-18, Allahabad, Sabaq-e- Urdu Publication.
- Rasheed, S. (2018). Woh Ek Pal. In: Adab Silsila (edited by Faridi, T.) pp 45-48, New Delhi, Adab Silsila Publications.
- Rasheed, S. (2018). Sadaye Bazgasht. In: Sabaq-e-Urdu (edited by Salim, M.) pp 42, Allahabad, Bhadohi, Sabaq-e-Urdu Publications.
- Rasheed, S. (2018). Cheque Book. In: Aiwan-e-Urdu (edited by Ali, S. M.) pp 37-39-48, New Delhi, Urdu Academy Delhi.

DEPARTMENT OF EDUCATION

- Yadav, Dhananjai “A Study of Achievement in Mathematics and Achievement” in Internation Multidisciplinary Refereed Bi Annual Journal UNIVERSAL REVIEW ISSN:2277-2723 vol- IX No. 01, Jan -June, 2018.
- Misra, K.S. and Pandey, D. (2018). Effectiveness of concept attainment strategy for teaching biology to class 9 students. ZENITH: International Journal of Multidisciplinary research, 2018, ISSN 2231-80
- Misra, and Pandey, D. (2018). Effectiveness of concept mapping teaching strategies for teaching biology to class 9th students, Review of Research, ISSN 2249-S949X.
- Misra, and Pal, S. (2018). Strategy of leaning strength among pupil teachers, Iternational journal of Research in Teacher Education, 9(1), PP. 1-5.
- Misra, K.S. and Sahani, S.K. (2018). Vanchan ke sandarbh me adhigam dabav kaa dhyayan, Internation Research Journal, 40(5), PP. 161-164.
- Misra, K.S. and Sahani, S.K. (2018). A study of leaning stress among BTC students, International Journal of Research, ISSN 2857-2861, 5(12).
- Misra, K.S. and Singh, P. (2018). Astudy of relationship between personality and learning stress among students, International Journal of Trend in Scientific Research and Development, ISSN 2456-6470, 2(1), pp. 111-113.
- Misra, and Pal, S. (2018). B.Ed. vidyarthiyon ke mansik swasthya par social networking sites ke prabhav kaa dhyayan, Vidyavarta, 22(4), pp. 153-156.
- Sahoo.P.K. & Kumar.B.(2018) Adhyapak Shikshakoki Sewakalin Shikshaki Awashytaka Adhyayan. Paripreksha N.U.E.P.A. New Delhi: Aug 2017, Vol-2, ISSN-0972-7515.
- Sahoo. P.K. & Sharma, P.(2018) Student teachers' perception towards curriculum reform in teacher education programme in Orissa, Educational Quest: An International Journal of Education and Applied Social Science: Vol-9-1, April, 2018, New Delhi Publishers. ISSN:0976-725.

- Sahoo.P.K. & Kumar.B.(2018) Shikshak Prashikshak ke Vritik Vikas Hetu Sewakalin Prashikshan Avashyaktaka Adhyan. Bhartiya Adhunik Shiksha N.C.E.R.T. New Delhi: July 2018, Vol-01, ISSN-0972-5636.
- Sahoo.P.K. & Sharma,P.(2018) Student teachers perception towards restructuring of teacher education programmes. Educational Quest: An International Journal of Education and Applied Social Science: Vol 9-187-201, August 2018, New Delhi Publishers. ISSN :2230-7311.
- Singh A. and Yadav V.(2018) *adhyapak shiksha me naveen do varsheey B.Ed. paathykram ka kriyanvayan evam anubhoot samasyayein: ek gunatmak adhyayan*, An International multidisciplinary Half yearly research Journal GENIUS vol.VI Issue II Feb-July 2018 ISSN 2279-0489 UGC listed Journal.
- Pandey, V.S. and Dubey, R. (2019), Relationship between emotional intelligence and family environment among senior secondary students: A study, International journal of Research in Economics and social sciences, vol.8, issue-3, March, ISSN- 2249-7382.
- Yadav, S. and Kumar, S. (2018) "RTE Act 2009-A boon for the Education of deprived" Techno-learn, an International journal of educational Technology, vol.8, Nov. 1, June, 2018, New Delhi Publishers, ISSN-2249-5223
- Yadav, S (2018), Attitude towards Teaching Profession among B.Ed. Students, APEAR Journal of Education, vol.16, School of Education, UPRTOU, Prayagraj, ISSN-0975-8666.
- JyotibaPhule v SavitribaiPhulekaStriShiksha me Yogdan. *Ajanta: An International Multidisciplinary Quaterly Research Journal. Aurangabad: Ajanta Prakashan. ISSN 22775730, Impact Factor 5.5, Volume No. VIII, Issue 1, January- March 2019, pp. 39-43.*
- A study of pupil teacher ratio in Government Primary Schools in Banda District. Published in The Journal of Education and Indian Perspective on September 2018, Vol. No. XII, Issue 2, ISSN 0976-934X.
- A comparative study of the awareness towards RTE Act 2009 among the primary teachers published in Techno Learn – An International Journal of Educational Technology, New Delhi Publishers in December 2018, Vol. No. 8, 2, ISSN 2231-4105.
- Sahoo P.K.(2018),- "Shri. SatyaSai Education for Human Values", Universal Religion and Education : Practitioners Perspectives, Seema Press, Varansai: November 201, ISBN No 978-93-5346-044-0.
- Singh A.&Yadav V.(2018) *Bhartiya Sandarbh me adhyapak shiksha karyakram: gudwatta, Dachhta avem prasangikta* , Changing Paradigm in Teacher Education, Eds. Zaman, Vidyapati, Sahae, Anubhav Publications, Allahabad. ISBN: 978-93-80134
- Sahoo P.K. & Prasad C. (2018),- " Decision Making Level of Students and Teacher Educators in Secondary Teacher Degree Programme of Open University", in Open Education in Human Resource Development in Asia's Period of Integration, pp. 1193-2107, Vol II, October 2018, Bach Khoa Publishing House, Hanoi, ISBN No. 978-604-95-0635-2.
- Sahoo. P.K. & B.C. Das (2018) Learners' Evaluation in Higher Education in Examination Reforms for Quality Higher Education in India. Delhi: New Delhi Publisher, ISBN 978-93-88879-10-1.
- Singh A & Vashishtha U.C. (2018) Nationalism of Pt. Deen Dayal and its resemblance with phenomenology, Seminar proceedings on Philosophy and social thoughts of Pt.Deen Dayal Upadhyaya, sept7-9 , 2017 Bhartiya Shiksha Shodh Sansthan, Lucknow.
- Yadav, S. Emerging trends in Indian Teacher Education – Challenges and suggestions. Changing Paradigm in Teacher Education, Anubhav Publications, Prayagraj, ISBN- 978-93-80134-87-1
- Yadav, S. and Kumar, S.(2018) Samaveshi Shiksha me Chintansheel shikshak ki bhoomika, Changing Paradigm in Teacher Education, Anubhav Publications, Prayagraj, ISBN- 978-93-80134-87-1
- Yadav, S. and Chaurasia, R.(2019), The caste system and equality of educational opportunities in India in Problems of caste in India-Investigating History and Histogramy, Meena Book Publications New Delhi. ISBN- 978-93-85957-10-9
- Astalin, P.K., Innovation in Teacher Education. Proceeding of National Seminar on Paramount Skills in Teacher Education for the Modern Epoch held on 5th and 6th April 2018 at Sri Sundareswari College of Education Malli, Sivakasi Road, Srivilliputtur, Virudhunagar, TN. Editor: P. Mallapparaj, ISBN 978-93-86568-35-9, pp. 597-606.

DEPARTMENT OF ENGLISH AND MODERN EUROPEAN LANGUAGES

- Sharma, Susheel Kumar "What is in a name?: Problematic of Anglo-Indian Literature", *The Indian Journal of English Studies*, LV, (2018), pp. 119-145. ISSN: L 0537-1988.

- Sharma, Susheel Kumar “Does a name Matter?: Problematic of Anglo-Indian Literature”, *Jodhpur Studies in English*, XVI, (2018), pp. 1-30. ISSN: L 0970-843X.
- Sharma, Susheel Kumar “What Is in a Name?: Problematic of Anglo-Indian Literature”, *International English Studies Journal*, University of Rzeszow (*Studia Anglica Resoviensia*, Uniwersytet Rzeszowski, Poland), 15(1), 2018, pp. 70-102. ISSN 1898-8709 (on-line); ISSN 1641-7666 (print)
- Sharma, Susheel Kumar “What Is in a Name?: Problematic of Anglo-Indian Literature”, *Littcrit: An Indian Response to Literature*, XLIV, 1(June 2018), pp. 38-54. ISSN: 0970-8049.
- Sharma, Susheel Kumar (a) “Indo-Anglian: Connotations and Denotations”, *East European Journal of Psycholinguistics*, V, 1 (2018), pp. 45-69. ISSN 2312-3265 (Print) 2313-2116 (Online) http://eepl.at.ua/_ld/1/182_EEJPL_5_1_2018_.pdf, <https://doi.org/10.5281/zenodo.1435964>
- Sharma, Susheel Kumar “Indo-Anglian: Connotations and Denotations”, *Madhya Bharati: Research Journal of Humanities and Social Sciences*, No. 75, July-December 2018, pp. 268-291. ISSN 0974-0066.
- Sharma, Susheel Kumar Why Desist Hyphenated Identities? Reading Syed Amanuddin’s “Don’t Call Me Indo-Anglian”, *East European Journal of Psycholinguistics*, V, 2 (2018), pp. 92-107. ISSN 2312-3265 (Print) 2313-2116 (Online) http://eepl.at.ua/load/volume_5_number_2_2018/sharma_s/203-1-0-190http://eepl.at.ua/_ld/1/190_EEJPL_5_2_2018_.pdf.
- ‘The Woman Question in Bangla Fiction’. *International Journal of English Language, Literature and Humanities* (Indexed, Peer Reviewed Journal) Vol 6, Issue 8, August 2018. ISSN-2321-7065
- ‘What I Learnt from Bridget: Reading Chicklit’. *Review of Research: International Online Multidisciplinary Journal*. Vol 8, Issue 5, February 2019. ISSN: 2249-894X

DEPARTMENT OF GEOGRAPHY

- Neda Waheed & Siddiqui, A.R. (2018) Livelihood and Health Status of Urban Slums: A case study on Allahabad city, India. In the *Oriental Anthropologist* Vol.18 No.1 (Jan-June Bi Annual International Journal of the Science & Man print Pub. New Delhi).
- Neda Waheed & Siddiqui, A.R. (2018) Assessment of Water, Sanitation and Hygiene Condition in Urban Slums-A Case study of Chakiya Slum in Allahabad city, *National Geographer*, Vol.1 ((Jan-June) July –December 2015 published in 2018, pp.95-102
- Shailendra Nath & Siddiqui, A.R. (2018) Distribution and moisture content of Municipal Solid Waste in different Wards of Kanpur city, India. In the *Pharma Innovation Journal*, Vol.No.7, pp 989-992 ISSN 2277-7655.
- Shailendra Nath & Siddiqui, A.R. (2018), Quantification and Characterization of Waste Selected Wards of Kanpur City, India in the *Journal of Pharma Cognosy and Phytochemistry* Vol.7 No.4 pp 1735-1738, ISSN 2278-4136
- Chandrashekhar Yadav & Siddiqui, A.R. (2018) Dynamics of Landuse /Land Cover change in Shankergarh Block of Allahabad district. In *Research Highlights*, Vol. Jan-March 2018 published by future fact society, Varanasi, India ISSN.2350-0611 UGC Journal no. 48441
- Yadav, A K and Siddiqui, A.R. (2018) Level of Irrigation Development in Banda District. *Journal of Institute of Landscape, Ecology & Ekistis, ILEL, Kolkata*, ISSN 0971-4170 vol 41, June 2018 pp-1-5
- Yadav, A.K and Siddiqui, A.R. (April 2018) Problems and prospects of livestock management in Banda District In *Annals of multi-Diciplinary Research*, ISSN 2249, vol 8, ISSUE-III, April, 2018
- Roohi Rawat and Siddiqui, A.R. (2019) Assessment of physio-Chemical Characteristics of Drinking Water Quality in Allahabad Metropolitan City in India, In the *Oriental Anthropologist*, Volume 19, Issue-1, June 2019, pp-121-135
- Roohi Rawat and Siddiqui, A.R. (2019) Assessment of Noise pollution levels in Major Commercial areas of Allahabad metropolitan City In *Deccan Geographer Journal* (accepted) for publication in Vol-57, No 1 & 2, June and December, 2019

DEPARTMENT OF HINDI AND MODERN INDIAN LANGUAGES

- Maurya, Dina Nath. (2018) *Navjagaran ke Daur Men Bhasayi Jameen ki Talash*, Pathshala: Bhar Bheetar, Azim prem ji University, Bengluru.
- Maurya, Dina Nath. (2018). *Aadhi Duniya ko ek kamre ki talash*, Pathshala: Bhar Bheetar. Azim prem ji University, Bengluru.
- Maurya, Dina Nath. (2018). *Sahitya ke Itihas Men Poorepan ki Talash*, Strikaal Magazine 27-28. 2394-093x.

- Maurya, Dina Nath. (2018). Khelgeet Jismen Khilti Hai Bhasha, Pravaah (lok sahitya visheshank).
- कुमार, अमितेश. (2018). यथार्थवाद का नया परिप्रेक्ष्य, तद्भव, वर्ष-7 अंक1, 235-239.
- कुमार, अमितेश. (2018) *अमृतलाल नागर का नाट्य साहित्य: एक सर्वेक्षण*, संवेद, वर्ष-10, अंक-3. 291-297
- कुमार, अमितेश. (2019)हिंदी समाज और रंगमंच, अकार, वर्ष-18 अंक- 51.145-151.
- यादव, शिव कुमार (2018)विरासत को बचाती है कविताएं, वागर्थ जून.
- यादव, शिव कुमार (2018) हिंदी विभागों का संस्मरणात्मक इतिहास, नया ज्ञानोदय, जून.
- यादव, शिव कुमार (2018) सौंदर्य की शमशेरियत के कवि, पाखी, जून.
- यादव, शिव कुमार (2018) कबीर का रोजनामचा, परिकथा, अक्टूबर.
- यादव, शिव कुमार (2019) सलीब पर सच का बयान, पाखी, फरवरी.
- अली, मुश्ताक. (2019). क्या प्रेमचंद विधवा विवाह के खिलाफ हैं, अनुसंधान,वर्ष- 14, अंक- 13. P. 7-11.
- सिंह, योगेन्द्र प्रताप(2019) वर्तमान पत्रकारिता के कुछ नए संदर्भ, अनुसंधान, वर्ष 14, अंक- 13. 12-17.
- सिंह, योगेन्द्र प्रताप. (2018)हिंदी विश्व भाषा की ओर, राजभाषा भारती, अप्रैल-जून.
- शुक्ल, शिव प्रसाद.(2019) गोरखनाथ और योग, अनुसंधान,वर्ष 14, अंक- 13. 18-27.
- शुक्ल, शिव प्रसाद.(2018) देशद्रोह और ऑपरेशन खुदाबख्श, साहित्य वीथिका.
- शुक्ल, शिव प्रसाद.(2019) दलित वैचारिकी, साहित्य वीथिका.
- सिंह, राकेश (2019)जयशंकर प्रसाद के नाटकों में अभिव्यक्त धार्मिक चेतना, अनुसंधान,वर्ष 14, अंक- 13. 28-40.
- गर्ग, राजेश कुमार(2019)भारतीय काव्यशास्त्र परंपरा में काव्य का स्वरूप, अनुसंधान,वर्ष 14, अंक- 13. 76-85.
- सिंह, सुनील विक्रम (2019). जगदीशचन्द्र माथुर व्यक्ति और रचनाकार, अनुसंधान,वर्ष 14, अंक- 13. 102-109.
- सिंह, विनयसेन.(2019) डॉ. नगेन्द्र की आलोचनात्मक दृष्टि का समीक्षात्मक, अनुसंधान,वर्ष 14, अंक- 13. 125-135.
- सिंह, सुजीत कुमार (2019), *मार्कण्डेय की कहानियां: ग्रामीण संवेदना और मानवीय यथार्थ*, अनुसंधान,वर्ष 14, अंक- 13. 194-207.
- कुमार, अमितेश. (2019)हिंदी साहित्येतिहास लेखन परंपरा और रंगमंच, अनुसंधान,वर्ष 14, अंक- 13. 136-156.
- कुमार, अमितेश. (2018)रंगमंचकाडिजिटलस्पेस,हंसकथामासिक, वर्ष 33, अंक 2, 199-205.
- पांडेय, वृजेश कुमार (2019). उच्चतर मूल्य चेतना का कवि केदारनाथ सिंह, अनुसंधान,वर्ष 14, अंक- 13.
- Gupta, Lakshman Prasad. (2019). Dekhiye, ab zindagi ki tarzamani hai ghazal, ANUSHANDHAN (ISSN-2249-9318), Year 14, vol. 13. P.162-178
- Tripathi, Amrendra (2019). `Rastra' kee parikalpana aur Ramvilas Sharma, Anusandhan, Year 14, vol. 13, 86-94
- Amrita. (2018). Vedon me vibhinn vidyaon ki avdharana, Anusandhan, Year 14, vol. 13. P. 110-115.
- Birendra, Kumar.(2018). Nirala Ke Upanyas, Subah Kee Dhoop, year-7, Issue-2, ISSN-2349-0233, P. 42-43
- Birendra, Kumar. (2018). Amrit Roy Kee Sahaj Kahani Vishayak Avdharna, Sambodhi, Issue-16, ISSN 2319-3751, P. 73-81.
- Birendra, Kumar.(2019). Allahabad Mein Nirala Ke Antim Din, Srijan Sarokar, Year-2, Issue-2, ISSN-2581-8856, P. 142-147.
- Birendra, Kumar. (2019), Pustak Samiksha Mein Chhayavad-Vivad, Anusandhan, Year-14, Issue-13, ISSN-2249-9318, P. 41-53
- Raju, Gajula. (2018). Telugu Sahitya main Hashiye ki Asmita” in Kalam Magazine pg.03-04.
- Raju, Gajula. (2018). Hindi Dalit Kavita ke Preranasroot:Dr BaBa Saheb Ambedkar” in an International magazine ‘Jankruti’, pg.91-95
- Partheshwar, A. (2018). Chand Ki Chitthiyan. Anusandhan, 13,67-75.
- Tripathi, Basant. (2018). Sumitranandan Pant ki prayogshilta baraste ‘Parivartan, Vagarth Issue 281. P. 98-103
- Tripathi, Basant. (2019). Muktibodh ki kavita me svapn aur yatharth ki kashmakash se jujhta bharaat ,Anusandhan, Year-14, Issue-13, ISSN-2249-9318. P. 54-66.
- Bijay Kumar,(2018) ‘Tulsiram ki drishti me dalit sahity’ pairokaar,vol.1, 52-56

- Maurya, Dina Nath. (2019). Tulnatmak Sahitya, ANUSHANDHAN (ISSN-2249-9318), Year 14, vol. 13. P.162-178
- Janardan, (2019), Gondi Se Prachin Bhartiya Itihas Ko Samjha ja Sakta hai. Kaksaaade, issn- 2456-2211. P. 43-45
- Kumari, Meena (2018). Choices of Terms of Address : A socio-pragmatic study of the novel 'Banbhatt ki Atmkatha'. Aligarh journal of linguistics, volume 08 special issue, pp 94-113, ISSN No. 2249-1511
- Kumari, Meena (2019). Gaza se patra (Translation of Letter from Gaza.). Vagarth. vol. 283, P. 89-93, ISSN No. 3294-1723
- Kumari, Meena (2019). Adamyia Urja aur Sampoorana Jeevan ke Kavi. Anusandhan, Vol. 13, Pp 208-230. ISSN No. 2249-9318, UGC Journal No. 41389
- यादव, शिव कुमार (2019), प्रेमचंद: मुक्तिकामी संघर्ष का योद्धा, अनुसंधान, वर्ष 14, अंक- 13.
- Tripathi, Surabhi(2018), Samkalin Hindi Sahitya me Mahila Lekhan, Shodh Mimansa,
- Singh, Santosh Kumar. (2018), Yatharthwadi Premchand, Naman
- सिंह, राकेश. (2018), राजकमलचौधरीकेकाव्यकंकावतीकाप्रतिपाद्य, शोध दृष्टि
- सिंह, राकेश. (2018), जयशंकर 'प्रसाद' केनाटकोंमेंअभिव्यक्तधार्मिकचेतना, शोध दृष्टि
- शुक्ल, शिव प्रसाद.(2019), किन्नर विमर्श और यमदीप, हिंदी साहित्य में किन्नर समाज (संपा- दिलीप मेहरा), दिल्ली:वाणी प्रकाशन.
- शुक्ल, शिव प्रसाद.(2019), भारतीय साहित्य अतीत और वर्तमान, भारतीय साहित्य चिंतन और चुनौतियां (संपा- मनोज पांडेय), दिल्ली:ए. आर. प्रकाशन.
- शुक्ल, शिव प्रसाद.(2018)किन्नर विमर्श और प्रदीप सौरभ के उपन्यास, किन्नर विमर्श, (संपा- दिलीप मेहरा), कानपुर:माया प्रकाशन.
- शुक्ल, शिव प्रसाद.(2018), संस्कृति की जननी आदिवासी कविता, आदिवासी काव्य चिंतन (संपा- खन्ना प्रसाद अमीन), दिल्ली.
- शुक्ल, शिव प्रसाद.(2018), दलित गिरमिटिया और लाल पसीना, प्रवासी कथा साहित्य (संपा- कल्पना गवली), कानपुर:माया प्रकाशन.
- शुक्ल, शिव प्रसाद.(2018), बुद्ध से अंबेडकर तक की यात्रा, भारतीय साहित्य और साहित्यकार (संपा – शशिकांत सोनवडे), कानपुर:माया प्रकाशन.
- Birendra, Kumar. (2018). Janta Ke Sangharsh Ke Sahbhagi Rahe Hain Madan Krishna Verma, Shatabdi Smaran: Madan Krishna Verma, (Edited by Pankaj Shrivastava) Page 45-47, Daltonganj: Madan Krishna Verma Shatabhi Smaroh Samiti.
- Tripathi Basant. (2019). 'Jivan aur kritiv ke parasparik sambandhon ki talash'. Kriti Mulyankan: Avara Masiha/(Ed.Pallav).New Delhi: Rajpal and Sons,
- पांडेय, बृजल कुमार (2018). आतंकवाद, नक्सलवाद और हिंदी कविता, आतंकवाद पर बातचीत, यश पब्लिकेशन, दिल्ली.
- कुमार, अमितेश. (2018), अंधेर नगरी चौपट राजा, कालजयी और युवा, रज़ा फाउंडेशन. 11-23.
- Tripathi, Basant. (2018). Sahity Manjiri (Text Book, B A III, Comp Hindi, Nagpur University (Editor), Raghav Publishers and Distributors.
- Tripathi, Basant. (2018). Sahity Manjiri.Sahity Vaibhav (Text Book, B A III, Hindi Literature, Nagpur University (Editor)
- कुमार, दिनेश. (2018), आचार्य रामचंद्र शुक्ल एक मूल्यांकन (संपादित), नई दिल्ली: सामयिक बुक्स

DEPARTMENT OF MEDIEVAL AND MODERN HISTORY

- Chaturvedi, Heramb (2019). *Kumbh: Atihasik Vaangmay*, New Delhi: Vani Prakashan ISBN (978-93 88684-83-5)
- Chaturvedi, Heramb. (2019) *Chaturvediyon ka Itihas*, Allahabad: Sahitya Sangam (ISBN: 978-81-8097-293-5)
- Chaturvedi, Heramb, *Madhya-Yugeen Ithihaas Lekhan ki Vyakya* (2018) ITIHAAS, 04, 85-95
- Chaturvedi, Heramb, *Kumbh se Sambandit Kuch Prasang* (2019) 80, 102-105
- Chaturvedi, Heramb. (2018). *Ram-Kahani Sitaram: An Indian Sepoy and 1857* in Told and Untold Facets of 1857 (edited by Awadhesh Kumar) pp 28-57. Delhi, Anamika Publishers (ISBN: 978-81-7975-852-6)
- Joshi, Lalit, *The Changing Face of Urban India: Allahabad City in Context in Small Cities and Towns in Global Area Emerging Changes and Perspective* (edited by R. N. Sharma & R. S. Sandhu), Delhi, Rawat Publications

- Srivastava, Sanjay (2019) *Purvmadhyakaleen Bharat mein Jaatipratha ka Vikaskram* In: Problems of Caste in India: Investigating History and Historiography (edited by Vikram Harijan), Delhi. Meena Book Publications. (ISBN: 978-93-85957-10-9)
- Prasad, Alok. (2019). *Social Exclusion and Education as reflected in Hindi Dalit Literature* In: Dalit Literature and Historiography: Questioning the Caste Hegemony in India. (edited by Vikram Harijan) Delhi. Meena Book Publications.
- Harish, P S (2018). *The Revolt of 1857 and Madras Presidency with special reference to Andhra and Tamilnadu* In: Told and Untold Facets of 1857 (edited by Awadhesh Kumar) pp 82-87. New Delhi, Anamika Publishers & Distributors (ISBN: 978-81-7975-852-6)
- Harish, P.S (2019). *Growth of Dalit Movement in a Historical Perspective – An Overview* In: Problem of Caste in India: Investigating History and Historiography (edited by Vikram Harijan) Delhi. Meena Book Publications (ISBN: 978-93-85957-10-9)
- Harijan, Vikram (2019) *Dalit Literature and Historiography: Questioning the Caste Hegemony in India*. Delhi, Meena Book Publications
- Harijan, Vikram (2019) *Problem of Caste in India: Investigating History and Historiography*. Delhi, Meena Book Publications. (ISBN: 978-93-85957-10-9)

DEPARTMENT OF MUSIC AND PERFORMING ARTS

- Mishra Nagendra , 2018, संगीत दिग्दर्शिकाएँ Agra, Shri Vinayak
- Ruchi Rani Gupta, 2018, तालों का पारस्परिक संबंध एवं रिश्तेदारियोंएँ New Delhi, Swakshar Publication
- Dr. Renu Johri, 2018, Divin Beats, New Delhi, Kanishk
- Dr. Renu Johri, 2018, Tal Mastakin, Varasnasi, Luminous
- Dr. Jyoti Mishra, 2019, हिंदुस्तानी संगीत में रागांगएँ New Delhi, Kanishka
- Jyoti Mishra, 2018-2019, उत्तर प्रदेश प्रयाग अंग, 307-310, Lucknow, Suchna Vibhag, U.P. Govt.
- Prof. Jayant Khot, 2018, Guru Shishya Parampara Evam Sangeet shiksha ke Vertman Swaroop Ka Vishleshan, Allahabad University, Sankalp Pratham Ank
- Sankalpana, 2018, Padma Bhushan Pt. Samta Prasad Ji ke Tabla Vadan Mein Ras Dhvani Ka Proyog, 25-27 Vol., Allahabad, Sankalpana
- Jyoti Mishra, 2019, Performing Arts : A Panoramic View, , Parbhani Maharashtra, New Man Publication

DEPARTMENT OF PHILOSOPHY

- Guha, Debashis. (2018) What is Ethical in Enviromental Ethics. *Journal of the Indian Council of Philosophical Research*, Vol.35, No.3.pp.
- Sahu, Gopal. (2018) Wittgenstein on Skepticism of External World. *Samdarshan*, Vol., 36, 45-51.
- Sahu, Gopal. (2018) Kusalal-dhamma for Wholesome Living. *Ravenshaw Journal of Philosophy*, Vol. IV, 22-30.
- Bhima Kumar, K. (2018) Perception and its nature in Buddhist Epistemology: Some Reflection, *Indian Philosophical Quarterly*, Vol.,45, No.2-3, 127-143.
- Bhima Kumar, K. (2018) The concept of *prama* and *pramana* in Buddhist theory of knowledge, *Ravenshaw Journal of Philosophy*, Vol.IV, 31-39.
- Maharana, Surya Kant. (2018) Persoanl Idenity and Identifying the Other Culture: A Phenomenological Approach. *Anvishiki*, Vol. No.XIII, 159-168.

DEPARTMENT OF POLITICAL SCIENCE

- Tiwari Satyam, The Tale of 'Forbidden' Love: 'Honour' Killings in India, Review of Research, Vol 7 (12) Sept 2018, pp. 1-4, 2249-894x
- Saurabh, Kumar (March-April 2018), पंचायतों की स्वायत्तता : वर्तमान परिदृश्य, International Journal of Advanced Educational Research, Volume-3; Issue 2, pp. 185-187, 2455-6157
- Saurabh, Kumar (March-April 2018), एक राष्ट्र एक चुनाव : चुनौतियाँ एवं सम्भावनाएँ, International Journal of Advanced Research and Development , Volume-3; Issue 2, pp. 521-524, 2455-4030

- Gupta, Neha (March-April 2018), Globalization And Challenges To Panchayati Raj Institutions, International Journal of Academic Research and Development, Volume-3; Issue 2, pp. 957-960, 2455-4197
- Gupta, Neha (March-April 2018), Ethnicity In North-East India: A Challenge To Identity, International Journal of Advanced Educational Research, Volume-3; Issue 2, pp. 292-294, 2455-6157
- Gupta, Neha (March-April 2018), Socio-Economic And Health Conditions Of Marginalized Groups Unorganised Working Class Women, International Journal of Advanced Research and Development , Volume-3; Issue 2, pp. 843-846, 2455-4030
- Harish Kumar Yadav, (Women's Status in Kashmir conflict –As an Agency of Violence), International Journal of Creative Research Thoughts, Volume 6 (2), pp. 206-209, 2320-2882
- Dileep Kumar, Mohan se Mahatma Tak ka Prarambhik Safar, Shri Prabhu Pratibha, Vol 2, Part 39, April June 2018, pp. 114-116, 0974-522x
- Savita Sahu, India's Foreign Policy Initiatives for Energy Security, Journal of Emerging Technologies and Innovative Research, Vol 6 (3), pp. 755-763, 2349-5162
- Rai V. K. , Chief Editor, Gandhi Marg ki Vishwyaakta : Sidhant Evam Vyawahar, 2019, New Delhi, Akhand Publishing House, ISSN-978-93-81416-921

DEPARTMENT OF PSYCHOLOGY

- Dwivedi, S. & Thapa, K. (2019). Understanding the nature of behavioural and emotional problems in adolescent students. International Journal of Social Science Review (Accepted for June Issue).
- Singh, S. & Punetha, D. (2019). Equivalent term of happiness for Hindi speaking youth: An exploration. International Journal of Social Science Review (Accepted for May Issue).
- Thapa, K. (2018). Towards an integrative approach to psychotherapy: Issues and prospects. Indian Journal of Clinical Psychology, 45, 4-10.
- Tripathi, R. C., Kumar, R., & Tripathi, V. N. (2019). When the advantaged feel victimised: The case of Hindus in India. *Psychology and Developing Societies*, 31 (1), 31-55.
- Tripathi, R. C., Kumar, R. Siddiqui, R. N. & Bano, S. (2018). Emotional reactions to intergroup norm violations. *Psychology and Developing Societies*, 30 (2), 234-261.
- Kumar, R. (2019). Addressing feelings of relative deprivation of Muslim minority for inclusive development. In Pandey, J. Kumar, R. & Thapa, K (Eds.). *Psychological Perspectives on Diversity and Development*. New Delhi: Springer.
- Thapa, K. (2019). Introduction. In J. Pandey, R. Kumar & K. Thapa (Eds.). *Psychological perspectives on diversity and development*. Springer.
- Tripathi, R.C. (Forthcoming). Unity of the individual and the collective. In G.Mishra (Ed.) ICSSR Survey in Psychology. New Delhi: Oxford University Press.
- Tripathi, R.C. (Forthcoming). Human Rights: Cross-nation and cross-cultural perspectives. In P. Hagenars and others (Eds.) Human rights education for psychologists. London: Routledge.
- Tripathi, R.C. (Forthcoming). Unothering of the other: The role of shared cultural spaces. In P. Graf and D.J. A. Dezois (Eds.). Handbook on the state of art in Applied Psychology. Hoboken, NJ: John Wiley.
- Pandey, J. Kumar, R. & Thapa, K (Eds.). *Psychological Perspectives on Diversity and Development*. New Delhi: Springer (2019)

DEPARTMENT OF SOCIOLOGY

- Ashish Saxena, 2018. 'Poornima Jain (Eds.) "Gender Issues", *Interrogating the feminist methodology in social science: Towards an interdisciplinary insights*' 2018, 978-93-65046-25-4, Studium Press, New Delhi.
- Ashish Saxena. 2018. 'State Initiatives, Developmentality and Lower Castes in Rural India: Analyzing mobility of Scheduled castes in rural Jammu Region, (J&K)', in 'B.K.Nagla & Vinay K. Srivastava (ed.) "Issues and Themes in Contemporary Society, Rawat Publication, New Delhi, 2018 (ISBN: 978-81-316-0993-4).
- Muneer Illath, 2018. In State and Public Policy, Minority Policies in India: A Post Sachar Scenario, Pentagon Publications, New Delhi (978-93-8661-823-8)
- Muneer Illath, 2018. In History of Leather, Working Castes in India: Social Transformation and Challenges *Tanneries and Tijarat: Social and Economic Vulnerabilities of Muslim Leather Workers in India*, Meena Publications, New Delhi. (978-93-85957-25-3)

- Ashish Saxena. (Book Review) Roland Robertson & John Simpson: The Art and Science of Sociology: Essay in honour of Edward A. Tiryakian, in *International Sociology* 34; 2, 169 - 172, (2019). (ISSN: 1461-7242)

DEPARTMENT OF URDU

- Dr. Sanjay Kumar: - Sanskrit Falsata – e- imbisat Aur Urdu Shayri July 2018, Ajkal Urdu Monthly Delhi.
- Dr. Sanjay Kumar :- “Nida Moid Ke Kalam Mein Hindu Muslim Ekta” Nida Fazli U.P Urdu Academy , Shakhsiyat Series – 2 Edited By Prof. A.A.Fatmi , 2017

DEPARTMENT OF COMMERCE & BUSINESS ADMINISTRATION

- Shukla, B.G. & Gupta, H. (2018). An Exploratory Study of Business Students Perspectives on Demonetization in India: With Special Reference to Allahabad City. *Research Journal of Social Science and Management*, 7 (9), 186-194.
- Shukla, B.G. & Gupta, H.& Kumar, A. (2018). An Empirical Study of Foreign Tourist Contribution in Indian Economy. *Journal of Economics and Commerce*, 9 (1), 32-36.
- Shukla, B.G., Gupta, H. & Srivastava, H. (2018). Consumers’ perception towards sustainable consumption in eastern u.p.: a comparative study of Varanasi and Allahabad district. *International Journal of Recent Scientific Research*, 9 (1), 23163-23168.
- Srivastava, H. & Mukesh, M. (2018). Impact of Employer Branding through Social Media to attract Employees towards organization. *Sanyojak*, 6 (10), 65-72
- Srivastava, H. & Mukesh, M. (2018). Indian Tourism market : The Potential Prospectives and Challenges. *Journal of Economics and Commerce*, 9 (1).
- Anvita Raghuvanshi & Abhishek Kumar Yadav, “Gold Exchange Traded Funds: A Perfect Substitute of Physical Gold.” Published in *International Journal of Management Studies*, Vol. V, Issue- 3(3), July 2018
- Anvita Raghuvanshi & Satya Prakash, “SHGs Role in Promoting Women Entrepreneurs: A Study of Select Literature.” Published in *International Journal of Management Studies*, Vol. V, Issue- 3, July 2018
- Gupta, H., Shukla, B.G. and Kumar, A. (2018). A Comparative Study of Contribution of Financial Institutions in India – with special reference to Kisan Credit Card Scheme. *Economic Revival in India - Issues and Challenges*, 245-254, ISBN – 978-93-86123-48-0.
- Nandan, S. (2018). Work-life Balance Initiatives in the Indian Public Sector Banks: Employees’ Perspective. (Edited by A. Chandra). *Sustainable Development through Gender Equality*. pp.239-248). New Delhi: Pentagon Press.
- Srijan Anant & Anvita Raghuvanshi, “Insolvency in Bankruptcy code, Challenges and prospects” 2016 Published in edited book “Economic Revival in India Issues and Challenges”, Edition 1st ISBN 978-93-86123-48-0, October 2018.
- Satya Prakash & Anvita Raghuvanshi, “Progress and Sustainability of SHG- Bank Linkage Programmes in India, Innovation in Business Management and Social Sciences, ISBN:978-93-87289-28-4, p. 348-354.
- Soodan,V.& Pandey, Akhilesh Chandra.(2018).‘Orientations vs. Consumer Behaviour: An emerging multidisciplinary approach to Consumer Psychology,*International Journal of Advance and Innovative Research*,5(4),pp.98-101,ISSN:e239477-80,October-December.
- Pandey,Akhilesh Chandra.(2018).‘Reality shock’ of Management Education in India: Issues and Challenges, *European Journal of Business and Management*,10(28),pp.62-67,ISSN:p2222-1905ISSNe 222-2839.

DEPARTMENT OF LAW

- Dr. Ajai Singh : Uniformity in Language’ : A Nexus to the People and Courts 10(1) DLR(2018) PP53-62.
- Dr. Ajai Singh : Chapter Uniform civil code Vis-à-vis protection of right of women under customary laws, Book constitutional law and uniform civil code in India at page 25-35 publication ABS publication Delhi.

DEPARTMENT OF BIOCHEMISTRY

- Joshi T, Singh AK, Haratipour P, Sah AN , Pandey AK, Naseri R, Juyal V, Farzaei MH. (2019) Targeting AMPK signaling pathway by natural products for treatment of diabetes mellitus and its complications. *Journal of Cellular Physiology*, 2019: 1–20. DOI: 10.1002/jcp.28528.
- Singh AK, Kumar R, Pandey AK. (2018) Hepatocellular carcinoma: Causes, mechanism of progression and biomarkers. *Current Chemical Genomics & Translational Medicine*. 12: 9-26. DOI: 10.2174/2213988501812010009.
- Singh AK, Bishayee A, Pandey AK. (2018) Targeting histone deacetylases with natural and synthetic agents: An emerging anticancer strategy. *Nutrients*. 10 (6): 731 (31 pages). Doi:10.3390/nu10060731.

- Singh N, Sharma B. (2019) Role of Toxicants in Oxidative Stress Mediated DNA Damage and Protection by Phytochemicals". EC Pharmacology and Toxicology 7.1-7.
- Kumar S, Sastry N, Yarla, Mishra V, Daim MA, Sharma B, Ashraf GM, Reggi R, Palmery M, Peluso I, Kamal MA. (2018) Single Probiotic versus Multiple Probiotics-A Debate in Current Scenario for Alleviating Health Benefits. Current Pharmaceutical Design 24: 1-4, DOI: 10.2174/1381612824666181012124136.
- Singh N, Kumar A, Gupta VK, Sharma B. (2018) Biochemical and Molecular Bases of Lead induced toxicity in mammalian systems and possible mitigations. Chemical Research In Toxicology (accepted) doi: 10.1021/acs.chemrestox.8b00193.
- Pandey R, Sharma B. (2018). Therapeutic Applications of Antiasthmatics, Consequences and Remedies. EC Pharmacology and Toxicology (2018) 6.7: 580-589.
- Singh N, Sharma B. (2018) A Brief Review on the Recent Advances in Phytotoxin Mediated Oxidative Stress. Pharmacologia. ISSN 2044-4648, DOI: 10.5567/
- Gupta VK, Sharma B. (2018) Phytochemicals from Indian Traditional Plants as Natural Potential Therapeutic Agents Against Adenosquamous Lungs. Pharmacologia. DOI: 10.5567/pharmacologia.2018.
- Gautam AK, Shrivastava N, Sharma B, Bhagyawant SS. (2018) Current Scenario of Legume Lectins and Their Practical Applications. Journal of Crop Science & Biotechnology 21: 217-227.
- Singh N, Sharma B. (2018) Biotoxins Mediated DNA damage and role of phytochemicals in DNA protection. Biochemistry and Molecular Biology Journal, 4(1):5-8.
- Al-Otaibi S, Arafah M, Sharma B, Alhomida AS, Siddiqi NJ. (2018) Synergistic effect of quercetin and a-lipoic acid on aluminium chloride induced neurotoxicity in rats. Journal of Toxicology (Published online). Volume 2018, Article ID 2817036, 8 pages; <https://doi.org/10.1155/2018/2817036>
- MK Chaudhary, SI Rizvi. (2019) Invertebrate and vertebrate models of aging research. A review; Biomed Pap Med Fac Univ Palacky Olomouc Czech Repub. DOI: 10.5507/bp.2019.003.
- Gour JK, Singh MK. (2018) Leishmanial excretory-secretory proteins/factors: A potent vaccine candidate, International Journal of Fundamental & Applied Sciences, 7, 18-22.
- Sharma UK, Kumar R, Gupta A, Ganguly R, Singh AK, Ojha AK, Pandey AK. (2019) Ameliorating efficacy of eugenol against metanil yellow induced toxicity in albino Wistar rats. Food and Chemical Toxicology, 126: 34-40. Doi: <https://doi.org/10.1016/j.fct.2019.01.032>.
- Sharma UK, Kumar R, Ganguly R, Gupta A, Sharma AK, Pandey AK. (2018) Cinnamaldehyde, an active component of cinnamon provides protection against food colour induced oxidative stress and hepatotoxicity in albino Wistar rats. Vegetos. 31(2): 123-129. Doi: 10.5958/2229-4473.2018.00063.0.
- Kumar R, Pandey AK (2018) Antioxidant and hepatoprotective activity of cinnamaldehyde against isoniazid induced hepatotoxicity. Free Radical Biology and Medicine. 120: (Suppl 1), S111. <http://dx.doi.org/10.1016/j.freeradbiomed.2018.04.366>.
- Sharma UK, Kumar R, Gupta A, Ganguly R, Pandey AK. (2018) Renoprotective effect of cinnamaldehyde in food color induced toxicity. 3 Biotech, 8:212 (5 pages). Doi: 10.1007/s13205-018-1241-z
- Gupta VK, Siddiqi NJ, Ojha AK, Sharma B. (2019) Hepatoprotective Effect of *Aloe vera* against Cartap and Malathion Induced Toxicity in Wistar Rats. Journal of Cellular Physiology (In Press). IF:3.923
- Singh S, Garg G, Singh AK, Bissoyi A, Rizvi SI. (2019) Fisetin, a potential caloric restriction mimetic, attenuates senescence biomarkers in rat erythrocytes. Biochem Cell Biol. 2019 (In press) doi: 10.1139/bcb-2018-0159.
- Singh AK, Singh S, Garg G, Rizvi SI. (2018) Rapamycin mitigates erythrocyte membrane transport functions and oxidative stress during aging in rats, Archives of physiology and biochemistry 124 (1), 45-53
- Chaudhary MK, Rizvi SI. (2018) Erythrocyte senescence in a model of rat displaying Hutchinson-Gilford progeria syndrome. Anal Cell Pathol (Amst). 2018 May 29;2018:5028925.
- Singh S, Singh, AK, Garg G., Rizvi, SI. 2018 Fisetin as a caloric restriction mimetic protects rat brain against aging induced oxidative stress, apoptosis and neurodegeneration, Life sciences 193, 171-179
- Garg G, Singh S, Singh AK, Rizvi SI. (2018). Whey protein concentrate supplementation protects erythrocyte membrane from aging induced alterations in rats. Journal of Food Biochemistry. 2018
- Garg G, Singh S, Singh A, Rizvi SI. (2018) N-acetyl L-cysteine attenuates oxidative damage and neurodegeneration in rat brain during aging. Canadian Journal of Physiology and Pharmacology. 2018 Aug 14.

- Singh AK, Singh S, Tripathi VK, Bissoyi A, Garg G, Rizvi SI. Rapamycin Confers Neuroprotection Against Aging-Induced Oxidative Stress, Mitochondrial Dysfunction, and Neurodegeneration in Old Rats Through Activation of Autophagy. *Rejuvenation Res.* 2018 Aug 23.
- Dwivedi A, Singh S, Mittal PC. (2018). Combining Metal Chelator and Antioxidant Improves Amelioration of Induced Lipid Peroxidation in the Human Erythrocyte Membrane. *Journal of Life Science*, 10(1): 47-57.
- Singh S, Dwivedi A, Mittal PC (2018). Anisocytosis is Associated with High Body Mass Index and Poor Adaptation to Oxidative Stress in Obese Patients with Type 2 Diabetes Mellitus. *Journal of Life Sciences*, 10(2) 123 -131.
- Singh S, Kumar S, Mittal PC, Dwivedi A (2019) Role of erythrocytes in adult diabetes induced oxidative stress. *International Journal of Research and Analytical Reviews*, 6 (1).
- Wang L, Kumar M, Deng Q, Wang X, Liu M, Gong Z, Zhang S, Ma X, Xu-Monette ZY, Xiao M, Yi Q, Young KH, Ramos KS, Li Y. (2018). 2,3,7,8-Tetrachlorodibenzo-p-dioxin (TCDD) induces peripheral blood abnormalities and plasma cell neoplasms resembling multiple myeloma in mice. *Cancer Lett*; 440-441:135-144.
- Nath N, Prasad HK, Kumar M (2018) Cerebroprotective effects of hydrogen sulfide in homocysteine-induced neurovascular permeability: Involvement of oxidative stress, arginase, and matrix metalloproteinase-9. *J Cell Physiol.* 234(3):3007-3019
- Qian Huang, Jiajia Xi, Lei Wang, Xu Wang, Xiaodong Ma, Qipan Deng, Yong Lu, Kumar M, Zhiyuan Zhou, Ling Li, Chaoyang Zeng, Ken Young, Qing Yi, Mingzhi Zhang, Yong Li. (2018). miR-153 Suppresses IDO1 Expression and Enhances CAR T Cell Immunotherapy. *Journal of Hematology and Oncology.* 11:58: 1-12
- Jiajia Xi, Qian Huang, Xiaodong Ma, Qipan Deng, Kumar M, Zhi Cao, Xu Wang, Lei Wang, Wei Li, Xinfang Yu, Yong Li. (2018). miR-21 Depletion in Macrophages Promotes Tumoricidal Polarization and Enhances PD-1 Immunotherapy. *Oncogene.* 37:3151-3165
- Chapter in Book – 21
- Singh AK, Pandey AK (2019) Potential Biotechnological Applications of Microalgae Grown in Wastewater: A Holistic Approach. In: *Application of Microalgae in Wastewater Treatment*, S. K. Gupta, F. Bux (eds.), Springer Nature Switzerland AG. https://doi.org/10.1007/978-3-030-13909-4_11.
- Kumar R, Pandey AK (2019) Medicinal and Industrial Applications of Bromelain. In: *Phytochemistry, Volume 3 (Marine Sources, Industrial Applications, and Recent Advances)*, Egbuna et al. (eds.), CRC Press & Apple Academic Press, Inc, Waretown, NJ, USA. pp 205-219.
- Singh AK, Rana HK, Pandey AK (2019) Fungal-Derived Natural Product: Synthesis, Function, and Applications. In: *Recent Advancement in White Biotechnology Through Fungi, Fungal Biology*, A. N. Yadav et al. (eds.), Springer Nature Switzerland AG. https://doi.org/10.1007/978-3-030-14846-1_8.
- Gupta A, Pandey AK (2019) Phytochemicals as Oxidative Stress Mitigators. In: *Phytochemistry: Volume 2: Pharmacognosy, Nanomedicine, and Contemporary Issues*, Egbuna et al. (eds.), - CRC Press Book, Apple Academic Press, Inc.
- Singh AK, Pandey AK (2018) Microalgae: An Ecofriendly Tool for the Treatment of Industrial Wastewaters and Biofuel Production, In: *Recent Advances in Environmental Management*, Ed. Bhargava RN, CRC Press, Taylor & Francis Group, Boca Raton, FL, USA. pp. 167-196. ISBN: 978-0-8153-8314-7.
- Pandey R, Tiwari P, Prakash V, Gupta VK, Sharma B (2019) Free Radicals and Antioxidant Defense in Asthma. In: *Oxidative Stress and Antioxidant Defense: Biomedical Value in Health and Diseases*. Eds: Md. Sahab Uddin and Aman B. Upananlawar, Nova Science Publisher, NY, USA
- Singh R, Sharma B (2018) Application of Hairy-Root Culture Technology in Phytoremediation for Environmental Cleanup: Past, Present, and Future Outlook. In: *Recent Advances in Environmental Management* (Eds. R.N.Bhargava), CRC Press, Taylor and Francis Group, Boca Raton, London, New York.
- Kumar A, Sharma B (2018) Consequences of Heavy Metals Pollution in the Environment and Their Bioremediation Practices. In: *Recent Advances in Environmental Management* (Eds. R.N.Bhargava), CRC Press, Taylor and Francis Group, Boca Raton, London, New York
- Kumar A, Singh N, Pandey R, Gupta VK, Sharma B (2018) Biochemical and Molecular Targets of Heavy Metals and Their Actions. In: *Biomedical Applications of Metals*, (Eds.: Mahendra Rai, Avinash P. Ingle and Serenella Medici), © Springer International Publishing AG, part of Springer Nature 2018. pp.297-319. ISBN 978-3-319-74814-6.

- Singh R, Sharma B (2018) Metal-Based Therapy in Traditional and Modern Medicine Systems. In: Biomedical Applications of Metals, (M. Rai et al. (Eds. Eds.: Mahendra Rai, Avinash P. Ingle and Serenella Medici), © Springer International Publishing AG, part of Springer Nature 2018. pp.195-211. ISBN 978-3-319-74814-6 (<https://link.springer.com/book/10.1007%2F978-3-319-74814-6>)
- Kumar R, Rizvi SI (2019) The Protective Role of Nutraceuticals and Functional Food in Hyperlipidemia. Nutraceutical and Functional Foods in Disease Prevention. IGI Global. 2019.
- Kumar R, Saraswat K, Rizvi SI (2019). Potential therapeutic impacts of curcumin against Age-related impaired cognition and memory. Curcumin for Neurological and Psychiatric Disorders DOI: doi.org/10.1016/B978-0-12-815461-8.00013-X Elsevier (Academic press).
- Singh AK, Singh S, Garg G, Rizvi SI (2018) Multinutrient Approach to Slow Down Brain Aging and Related Neurodegenerative Disorders, In: Role of the Mediterranean Diet in the Brain and Neurodegenerative Diseases. Farooqui, A. and Farooqui, T (eds) pages 77-88, Elsevier, USA
- Pandey KB, Rizvi SI (2018). Plant Polyphenols in Healthcare and Aging, In: Nutritional Antioxidant Therapies: Treatments and Perspectives edited by Kais Hussain Al-Gubory, Ismail Laher. Springer, Germany, 267-282.
- Singh AK, Singh S, Rizvi SI (2018) Autophagy Induction: A Promising Antiaging Strategy; Molecular Basis and Emerging Strategies for Anti-aging Interventions S. I. Rizvi, U. Çakatay (eds.) Springer Nature Singapore Pte Ltd. 2018.
- Saraswat K, Kumar R, Rizvi SI (2018) Inhibition of mTOR Signalling: A Potential Anti-aging Drug Strategy; Molecular Basis and Emerging Strategies for Anti-aging Interventions S. I. Rizvi, U. Çakatay (eds.) Springer Nature Singapore Pte Ltd. 2018.
- Tripathi SS. (2018) Epigenetic Changes in Aging and Modulation by Dietary Nutrients; Molecular Basis and Emerging Strategies for Anti-aging Interventions S. I. Rizvi, U. Çakatay (eds.) Springer Nature Singapore Pte Ltd. 2018.
- Dwivedi A, Singh S, Kumar S, Mittal PC (2019). Invited review: Organosulfur phytochemicals against metabolic and neurodegenerative diseases: Benefits and risks. In “Phytochemicals as lead compounds for new drug discovery: Recent Advances”, Ed. Chukwuebuka E, Polgar T, Kumar S, Ezzat SM, Jonathan C. Ifemeje and Kaliyaperumal S. Elsevier Inc.
- Sivakumar Vijayaraghavalu, Ritambhara, Himanshu K. Prasad, Kumar M (2018) Advances in Biological Treatment of Industrial waste water and their recycling for a sustainable future: Treatment and Recycling of Winery Waste water. Pp 167-198, Springer Nature publication.
- Ritambhara, Zainab, Vijayaraghavalu S, Prasad HK, Kumar M (2018) Advances in Biological Treatment of Industrial waste water and their recycling for a sustainable future: Treatment and Recycling Waste water from Dairy Industry. Pp 91-118 Springer Nature Publication.
- Belwal T, Devkota HP, Singh MK, Sharma R, Upadhayay S, Joshi C, Bisht K, Gour JK, Bhatt ID, Rawal RS, Pande V. (2019). Chapter 3.40- John's Wort (*Hypericum perforatum*) In : Nonvitamin and Nonmineral Nutritional Supplements (edited by- Mohammad Nabavi and Ana Sanches Silva) pp 415-432. Elsevier. <https://www.sciencedirect.com/science/article/pii/B9780128124918000564>
- Sharma B. (2018) Human immunodeficiency virus type 1 reverse transcriptase (HIV-1RT) catalysed misinsertion and mispair extension and drug resistance. In: Proceedings of an International Conference on Trends in Biochemical and Biomedical Research: Advances and Challenges. Research Reports; 2:e1-e205. doi:10.9777/rr.2018.1001-10319. (www.companyofscientists.com/index.php/chd)
- Sharma B. Jaiswal SK, Gupta VK (2018) Inhibition of mammalian acetylcholinesterase by carbofuran and protection by vitamin C and Citrus limon fruit extract. Annual Congress on Medicinal Chemistry, Pharmacology and Toxicology held on July 30-31 at Amsterdam, Netherland. J Org Inorg Chem. 4; DOI: 10.21767/2472-1123-C3-009
- Rizvi SI, Cakatay U. (eds) (2018) Molecular Basis and Emerging Strategies for Anti-aging Interventions, Springer NATURE.

DEPARTMENT OF BOTANY

- Tripathi DK, Singh S, Shweta, Singh S, Yadav V, Liu S, Singh VP, Sharma S, Srivastava P, Prasad SM, Dubey NK, Chauhan DK, Sahi S (2018). Acquisition and Homeostasis of Iron in Higher Plants and Their Probable Role

- in Abiotic Stress Tolerance. *Frontiers in Environmental Science* <https://doi.org/10.3389/fenvs.2017.00086>. (Impact factor 3.14; Frontiers).
- Jain S, Muneer S, Guerriero G, Liu S, Vishwakarma K, Chauhan DK, Dubey NK, Tripathi DK, Sharma S (2018). Tracing the role of plant proteins in the response to metal toxicity: a comprehensive review. *Plant Signaling & Behavior* <https://doi.org/10.1080/15592324.2018.1507401>. (Impact factor 1.64; Taylor & Francis).
 - Rastogi A, Tripathi DK, Yadav S, Chauhan DK, Živčák M, Ghorbanpour M, El-Sheery NI, Brestic M (2019). Application of silicon nanoparticles in agriculture. *3 Biotech* 9:90 <https://doi.org/10.1007/s13205-019-1626-7>. (Impact factor 1.79; Springer).
 - Sharma N, Khajuria Y, Sharma J, Tripathi DK, Chauhan DK, Singh VK, Kumar V, Singh VK (2018). Microscopic, elemental and molecular spectroscopic investigations of root-knot nematode infested okra plant roots. *Vacuum* 158, 126-135. (Impact factor 2.52; Elsevier).
 - Singhal A, Kumar M, Bhattacharya M, Kumari N, Jha PK, Chauhan DK, Thakur IS (2018). Pretreatment of *Leucaena leucocephala* wood by acidified glycerol: optimization, severity index and correlation analysis. *Bioresource Technology* 265, 214-223. (Impact factor 6.67; Elsevier).
 - Tiwari PK, Gaur S, Singh AK, Tripathi DK, Chauhan DK, Rai AK, Singh VP, Prasad SM (2019). Liquid assisted pulsed laser ablation synthesized copper oxide nanoparticles (CuO-NPs) and their differential impact on rice seedlings. *Ecotoxicology and Environmental Safety*. 176, 321-329. (Impact factor 4.53; Elsevier).
 - Khan MY, Prakash V, Yadav V, Chauhan DK, Prasad SM, Ramawat N, Singh VP, Tripathi DK, Sharma S (2019). Regulation of cadmium toxicity in roots of tomato by indole acetic acid with special emphasis on reactive oxygen species production and their scavenging. *Plant Physiology and Biochemistry*. 142, 193-201. (Impact factor 3.40; Elsevier).
 - J Kumar, Patel A, Tiwari S, Tiwari S, Srivastava PK, Prasad SM (2018). Pretilachlor toxicity is decided by discrete photo-acclimatizing conditions: Physiological and biochemical evidence from *Anabaena* sp. and *Nostoc muscorum*. *Ecotoxicology and Environmental Safety* 156, 344–353. (Impact factor 4.53; Elsevier).
 - Kushwaha BK, Singh S, Tripathi DK, Sharma S, Prasad SM, Chauhan DK, Kumar V, Singh VP (2019). New adventitious root formation and primary root biomass accumulation are regulated by nitric oxide and reactive oxygen species in rice seedlings under arsenate stress. *Journal of Hazardous Materials*. 361, 134-140. (Impact factor 7.65; Elsevier).
 - Parihar P, Singh R, Prasad SM (2018). Regulatory role of oxylipins on growth and secondary metabolites under simultaneous treatments of NaCl and UV-B stress in *Luffa* Mill. Seedlings. *International Journal of Agricultural Sciences* 9, 30-36. ISSN no. 0974-6065
 - Patel A, Tiwari S, Prasad SM (2018). Toxicity assessment of arsenate and arsenite on growth, chlorophyll a fluorescence and antioxidant machinery in *Nostoc muscorum*. *Ecotoxicology and Environmental Safety* 157, 369–379. (Impact factor 4.53; Elsevier).
 - Singh A, Prasad SM, Singh S (2019). Role of nano-powder of *Azadirachta indica* leaves to regulate the physiological responses and metal uptake in *Triticum aestivum* seedlings. *Chemistry and Ecology*. doi.org/10.1080/02757540.2019.1579198. (Impact factor: 1.21; Taylor and Francis).
 - Singh M, Bashri G, Prasad SM, Singh VP (2019). Kinetin alleviates UV-B induced damage in *Solanum lycopersicum*: Implications of phenolics and antioxidants. *Journal of Plant Growth Regulation*. (Impact factor 2.18; Springer)
 - Singh P, Prasad SM (2018). Antioxidant enzyme responses to the oxidative stress due to chlorpyrifos, dimethoate and dieldrin stress in palak (*Spinacia oleracea* L.) and their toxicity alleviation by soil amendments in tropical croplands. *Science of the Total Environment* 630, 839–848. (Impact factor 5.59; Elsevier).
 - Singh R, Parihar P, Prasad SM (2018). Co-application of sulphur and calcium modulates arsenic induced toxicity by regulating different metabolites in *Brassica juncea* L. seedlings. *International Journal of Environmental Science* 8, 213–219. ISSN no. 0976-4534. (Impact factor 3.12; Elsevier)
 - Singh R, Parihar P, Prasad SM (2018). Simultaneous exposure of sulphur and calcium hinder As toxicity: Up-regulation of growth, mineral nutrients uptake and antioxidants system. *Ecotoxicology and Environmental Safety* 161, 318–331. (Impact factor 4.53; Elsevier).
 - Singh R, Parihar P, Prasad SM (2018). Sulphur and calcium simultaneously regulate photosynthetic performance and nitrogen metabolism status in As-challenged *Brassica juncea* L. seedlings. *Frontiers in Plant Science* 9, 772 (Impact factor 4.11; Frontier).

- Singh S, Prasad SM (2019). Management of chromium (VI) toxicity by calcium and sulfur in tomato and brinjal: implication of nitric oxide. *Journal of Hazardous Materials*. doi.org/10.1016/j.jhazmat.2019.01.044. (Impact factor 7.65; Elsevier).
- Singh S, Prasad SM (2019). Regulation of chromium toxicity tolerance in tomato and brinjal by calcium and sulfur through nitric oxide: involvement of enzymes of sulfur assimilation and the ascorbate-glutathione cycle. *Environmental and Experimental Botany*. In press (Impact factor 3.12; Elsevier).
- Tiwari S, Patel A, Prasad SM (2018). Kinetin alleviates chromium toxicity on growth and PS II photochemistry in *Nostoc muscorum* by regulating antioxidant system. *Ecotoxicology and Environmental Safety* 161, 296–304. (Impact factor 4.53; Elsevier).
- Tiwari S, Verma N, Singh VP, Prasad SM (2018). Nitric oxide ameliorates aluminium toxicity in *Anabaena PCC 7120*: Regulation of aluminium accumulation, exopolysaccharides secretion, photosynthesis and oxidative stress markers. *Environmental and Experimental Botany*. doi.org/10.1016/j.envexpbot.2018.10.026. (Impact factor 3.12; Elsevier).
- Kumar G, Pandey A (2018). Ethyl methane sulphonate induced changes in cyto-morphological and biochemical aspects of *Coriandrum sativum* L. *Journal of the Saudi society of Agricultural Sciences*. (ISSN -1658-077X).
- Kumar G, Singh S (2018). Nuclear polymorphism induced genomic instability in Cluster bean (*Cyamopsis tetragonoloba* (L.) Taub.). *Cytologia*. Vol. 83(2) (ISSN 0011-4545).
- Kumar G, Singh S (2018). Enigmatic phenomenon of secondary association among bivalents in Guar (*Cyamopsis tetragonoloba* (L.) Taub.). *Cytology and Genetics*. Vol. 52 (ISSN 0095-4527).
- Kumar G, Mishra R, Singh R (2018). Chromotoxic effects of food dyes in root meristems of *Foeniculum vulgare* Mill. *Chromosome Botany*. Vol 13. (ISSN: 1881-5936).
- Kumar G, Singh S (2018). Effect of temperature constraints on morphological and cytogenetical attributes in Cluster bean [*Cyamopsis tetragonoloba* (L.) Taub]. Vol 12. *Jordan Journal of Biological Sciences Accepted* (ISSN 1995-6673).
- Kumar G, Srivastava A (2018). EMS induced desynaptic male sterile lines in Buckwheat (*Fagopyrum esculentum* Moench). *Cytology and Genetics*. Accepted. Vol. 53: (4). (ISSN 0095-4527).
- Kumar G, Bhardwaj M (2019). EMS induced inter-segmental non homologous interaction in *Cuminum cyminum* L. *Cytologia*. Vol 84 (ISSN 0011-4545).
- Kumar G, Bhardwaj M (2019). Induced genetic variations in *Cuminum cyminum* through supplemental UV-B radiation. *Journal of Environmental Biology*. Vol. 40. (ISSN 0254-8704).
- Kumar G, Pandey A (2019). Cytogenetical investigation of a Translocation Heterozygote Induced by Gamma rays in *Coriandrum sativum* L. *Cytologia*. Accepted Vol. 84 (ISSN 0011-4545).
- Kumar G, Diwivedi H (2019). Induced syncyte formation via cytomixis in *Trachyspermum ammi* (L.) Sprague (Apiaceae). *Caryologia* (ISSN 0008 – 7114).
- Srivastava N, Kumar G, (2019). Zinc Chloride Induced Meiotic Aberrations in Green Manure Crop *Sesbania cannabina* Poir. (Dhaincha). *Cytologia* (ISSN 0011-4545).
- Kumar G, Srivastava A, Singh R (2019). Impact of Nanoparticles on Genetic integrity of Buckwheat (*Fagopyrum esculentum* Moench). *Jordan Journal of Biological Sciences Accepted* (ISSN 1995-6673).
- Haque, S. Yadav, D.K., Bisht, S.C., Yadav, N. Singh, V. Dubey, K.K. Jawed, A. Wahid, M., Dar, S.A. (2019) Quorum sensing pathway in Gram-positive bacteria and -negative bacteria: potential of their interruption in abating drug resistance. *J Chemother* Jul 31(4): 161-187 doi: 10.1080/1120009X.2019.1599175. Epub 2019 Apr 22.
- Thakur B., R. Yadav, L. Fraissinet-Tachet, R. Marmesse and M. Sudhakara Reddy. (2018) "Isolation of Multi-Metal Tolerant Ubiquitin Fusion Protein from Metal Polluted Soil by Metatranscriptomic Approach." *J Microbiol Methods* 152, : 119-125.
- Thakur B., R. Yadav, L. Vallon, R. Marmesse, L. Fraissinet-Tachet and M. Sudhakara Reddy. (2019) "Multi-Metal Tolerance of Von Willebrand Factor Type D Domain Isolated from Metal Contaminated Site by Metatranscriptomics Approach." *Sci Total Environ* 661, : 432-440.
- Mukherjee, A., R. Yadav, R. Marmesse, L. Fraissinet-Tachet and M. S. Reddy. (2019) "Heavy Metal Hypertolerant Eukaryotic Aldehyde Dehydrogenase Isolated from Metal Contaminated Soil by Metatranscriptomics Approach." *Biochimie* 160, : 183-192.
- Mukherjee A., Yadav R., Marmesse R, Fraissinet-Tachet L., M. Sudhakara Reddy. (2019) "Detoxification of toxic heavy metals by serine protease inhibitor isolated from polluted soil." *International Biodeterioration & Biodegradation* 143 <https://doi.org/10.1016/j.ibiod.2019.104718>

- Singh S, Bashri G, Prasad SM (2019). Introduction to herbs and their therapeutical potential: recent trends, in book “Medicinal plants chemistry, pharmacology and therapeutic application”, Eds. Swamy MK, Patra JK, Rudramurthi GR Taylor and Francis (CRC Press) USA (Accepted).
- Singh S, Fatima A, Tiwari S, Prasad SM (2019). Plant responses to radiation stress and its adaptive mechanism, in book “Plant Life under Changing Environment” Eds. Durgesh Kumar Tripathi, Vijay Pratap Singh, Devendra Kumar Chauhan, Shivesh Sharma, Sheo Mohan Prasad, Navneet Kumar Dubey, Naleeni Ramawat; Elsevier (2019).
- Tiwari S, Gupta D, Fatima A, Singh S, Prasad SM (2019). Phytohormones and their metabolic engineering for abiotic stress, in book “Plant Life under Changing Environment”, Eds. Durgesh Kumar Tripathi, Vijay Pratap Singh, Devendra Kumar Chauhan, Shivesh Sharma, Sheo Mohan Prasad, Navneet Kumar Dubey, Naleeni Ramawat; Elsevier (2019).
- Tiwari S, Parihar P, Patel A, Singh R, Prasad SM (2019). Metals in cyanobacteria: Physiological and molecular regulation, in book “Cyanobacteria : From basic science to applications”, Eds. Mishra AK, Tiwari DN, Rai AN (Elsevier) (Accepted).
- Patel A, Tiwari S, Parihar P, Singh R, Prasad SM (2019). Carbon nanotubes as plant growth regulators: impacts on growth, reproductive system, and soil microbial community; in book “Nanomaterials in plants, algae and microorganism: concepts and controversies: terrestrial ecosystem”; Vol 2; Ahmad P, Tripathi DK, Chauhan DK, Dubey NK, Sharma S. <https://doi.org/10.1016/B978-0-12-811488-9.00002-0>.
- Singh R, Parihar P, Singh A, Prasad SM (2018). Toxicity of heavy metal and its mitigation strategies through application of nutrients, hormones and metabolites, in book “Metabolic adaptation in plant during abiotic stress”, Eds. Akula R, Gill SS; Taylor and Francis (CRC Press) USA pp. 81-98.
- Tiwari S, Singh A, Prasad SM (2018). Regulation of pesticide stress on metabolic activities of plant, in book “Metabolic adaptation in plant during abiotic stress”, Eds. Akula R, Gill SS, Taylor and Francis (CRC Press) USA PP. 99-110.
- Bashri G, Parihar P, Singh R, Patel A, Prasad SM (2018). Plant and nanoparticle interface at the molecular level: an integrated overview; in book “Nanomaterials in Plants, algae and microorganisms: concepts and Controversies”; Eds. Tripathi DK, Ahmad P, Sharma S, Chauhan DK, Dubey NK; Elsevier, pp. 325–344.
- Bashri G, Patel A, Singh R, Parihar P, Prasad SM (2018). Mineral solubilization by microorganisms: mitigating strategy in mineral deficient soil; in book “Microbial biotechnology”; Eds. Patra JK, Vishnuprasad CN, Das G; Springer, pp. 265–285.
- Singh S, Srivastava PK, Singh VP, Prasad SM (2018). Life in ancient era: the evolution of photosynthesis; in book “Environment and photosynthesis: a future prospect”; Eds. Singh VP, Singh S, Singh R, Srivastava PK, Prasad SM; Studium press, USA., pp. 1–6.
- Vishwakarma K, Upadhyay N, Kumar N, Tripathi DK, Chauhan DK, Sharma S, Sahi S (2018). Potential Applications and Avenues of Nanotechnology in Sustainable Agriculture. *Nanomaterials in Plants, Algae, and Microorganisms: concepts and controversies* 1, 473-500.
- Shweta, Tripathi DK, Chauhan DK, Peralta-Videa JR (2018). Availability and Risk Assessment of Nanoparticles in Living Systems: A Virtue or a Peril? *Nanomaterials in Plants, Algae, and Microorganisms: concepts and controversies* 1, 1-31.
- Arif N, Yadav V, Singh S, Tripathi DK, Dubey NK, Chauhan DK, Giorgetti L (2018). Interaction of Copper Oxide Nanoparticles With Plants: Uptake, Accumulation, and Toxicity. *Nanomaterials in Plants, Algae, and Microorganisms: concepts and controversies* 1, 297-310.
- Title “Environment and Photosynthesis: A Future Prospect”. Editors: Vijay Pratap Singh, Samiksha Singh, Rachana Singh, Prabhat Kumar Srivastava, Sheo Mohan Prasad; Studium Press, USA (2018).
- Title “Pesticides and Crop Productivity” Editors: Prabhat Kumar Srivastava, Anita Singh, Vijay Pratap Singh, Durgesh Kumar Tripathi, Samiksha Singh, Sheo Mohan Prasad; WILEY Chichester, West Sussex, UK (2019).
- Title “Plant Life under Changing Environment” Editors: Durgesh Kumar Tripathi, Vijay Pratap Singh, Devendra Kumar Chauhan, Shivesh Sharma, Sheo Mohan Prasad, Navneet Kumar Dubey, Naleeni Ramawat; Elsevier (2019).
- Title “Nanomaterials in Plants, Algae, and Microorganisms: Concepts and Controversies” Volume 1. Editors; Tripathi DK, Ahmad P, Sharma S, Chauhan, DK, Dubey NK (2018). Academic Press; An imprint of Elsevier.

- Title “Nanomaterials in Plants, Algae, and Microorganisms: Concepts and Controversies” Volume 2. Editors; Tripathi DK, Ahmad P, Sharma S, Chauhan, DK, Dubey NK (2018). Academic Press; An imprint of Elsevier.

DEPARTMENT OF CHEMISTRY

- Dinesh Mani : Soil Health Management For Sustainable Agriculture, (ISBN- 978-81-910835-0-7), Publisher- Panchjanya Prakashan, F-2/2-A, Budh Vihar, Phase-I, Delhi-110086, Edition- 2019
- Madhu Yadav, Ritika Srivastava, Farha Naaz, Anuradha Singh, Rajesh Verma and Ramendra K. Singh (2019). *In silico* studies on new oxathiadizoles as potential anti-HIV agents, *Gene Reports*, 14, 87-93.
- Madhu Yadav, Ritika Srivastava, Farha Naaz, and Ramendra K. Singh* (2018). Synthesis, docking, ADMET prediction, cytotoxicity and antimicrobial activity of oxathiadizole derivatives, *Computational Biology and Chemistry*, 77, 226-239.
- Ritika Srivastava, Sunil K. gupta, Farha Naaz, Anuradha Singh, Vishal Kumar Singh, Rajesh Verma, Nidhi Singh and Ramendra K. Singh* (2018). Synthesis, antibacterial activity, synergistic effect, cytotoxicity docking and molecular dynamics of benzimidazole analogues, *Computational Biology and Chemistry*, 76, 1-16.
- Farha Naaz, Ritika Srivastava, Anuradha Singh, Nidhi Singh, Rajesh Verma, Vishal Kumar Singh and Ramendra K. Singh* (2018). Molecular modeling, synthesis, antibacterial and cytotoxicity evaluation of sulfonamide derivatives of benzimidazole, indazole, benzothiazole and thiazole, *Bioorganic and Medicinal Chemistry*, 26, 3414-3428.
- Anuradha Singh, Ritika Srivastava, and Ramendra K. Singh* (2018). Design, synthesis, and antibacterial activities of novel heterocyclic arylsulphonamide derivatives, *Interdisciplinary Sciences Computational Life Sciences*, 10, 748-761.
- Anuradha Singh, Vishal Kumar Singh, Rajesh Verma and Ramendra K. Singh* (2018). *In silico* Studies on N-(Pyridin-2-yl) Thiobenzamides as NNRTIs against Wild and Mutant HIV-1 Strains, *Philippine Journal of Science*, 147, 37-46.
- Dinesh Mani, Vipin Sahu and Bechan Singh (2018). Accumulation of Cadmium and Chromium in Amaranthus grown in sewage irrigated soils of Allahabad
- Journal of Natural Resource and Development, 13,2,pp 18-24.
- Nand Kishor Sahu and Shekhar Srivastava (2018). Some new Organo Thallium (III) Molecular adducts with bidentate Schiff Base Ligands: An Photoelectron Spectroscopic Study IJARSE 3111-3116.
- Abhishek Kumar, Shishir Malviya, Rajeev Lohiya, Toyaj Shukla and Shekhar Srivastava (2018) Synthesis and characterization of [PbX₂O₂MC₁₂].L1] compounds with macrocyclic ligands Asian Journal of Chemistry 30(11) 2415-2420.
- Subhash Chandra Shrivastava, Shekhar Srivastava, Rupali Sethi and J.D. Pandey (2019) Computation of Thermodynamic, thermophysical and thermoacoustical Properties of Liquid metals using sonic speed and density data. Journal of Biological and Chemical Research Vol. 36(1A) 137-143.
- Subhash Chandra Shrivastava, Shekhar Srivastava, Rupali Sethi and N.K. Soni (2019) Computation of Thermodynamic, thermophysical and thermoacoustical Properties of Liquid metals-alloys using density and sonic speed data Journal of Biological and Chemical Research Vol. 36(2B) 52-70.
- Nishita Chandra, Krishna Srivastava and Jagdish Prasad (2018) Electrochemical and spectral behaviour of some copper (II) mixed ligand complexes involving pyridine-3,5 –dicarboxylic acid and diimines in Dimethylsulfoxide 7(6) 1676-1681.
- Alka Srivastava, Krishna Srivastava and Jagdish Prasad (2019) Synthesis, structures and Photoluminescence Properties of Zinc (ii) and Cadmium (II) metal complexes constructed from 3,4-Pyridinedicarboxylic acid and aromatic diimines Journal of Applicable Chemistry Vol. 8(2) 661-679.
- Jyoti Tiwari, Swastika Singh, Fatima Tufail, Deepali Jaiswal, Jaya Singh, Jagdamba Singh (2018) Glycerol Micellar Catalysis: An Efficient Multicomponent-Tandem Green Synthetic Approach to Biologically Important 2, 4-Disubstituted Thiazole Derivatives. ChemistrySelect ISSN No. 2365-6549 slct.201802511R2
- Deepali Jaiswal, Jyoti Tiwari, Shailesh Singh, Amit Sharma, Jaya Singh, Jagdamba Singh (2018) Sarcosine as a novel and recyclable organocatalyst: A greener approach towards the synthesis of multisubstituted pyrazole derivatives. Curr. Organocatal. ISSN No. 2213-3372 10.2174/2213337205666180810123412.
- Jyoti Tiwari, Swastika Singh, Fatima Tufail, Deepali Jaiswal, Amit Sharma, Shailesh Singh, Jaya Singh, Jagdamba Singh (2018) An Efficient, Convenient and One-pot Synthesis of Diversified Benzochromenes Using L-

valine as an Organocatalyst: A Green Prot Curr.Catal. ISSN No. 2211-5447
10.2174/2211544707666180924102729

- Fatima Tufail, Mohammad Saquib, Swastika Singh, Jyoti Tiwari, Preeti Dixit, Jaya Singh, Jagdamba Singh (2018) A practical green approach to diversified spirochromene/spiropyran scaffolds via a glucose-water synergy driven organocatalytic system *New J. Chem.* ISSN No 1144-0546 10.1039/c8nj03028f.
- Shailesh Singh, Jyoti Tiwari, Deepali Jaiswal, Amit K. Sharma, Jaya Singh, Vandana Singh, Jagdamba Singh (2018) Organocatalyst Mediated One Pot Synthesis of 4H-furo[3,4-b]pyran, 4H-benzo[g] chromene and 1H-benzo[b]xanthene Derivatives in Aqueous Medium: A Green Approach. *Curr. Organocatal.* 10.2174/2213337205666180614113032
- Jyoti Tiwari, Mohammad Saquib, Swastika Singh, Fatima Tufail, Amit K. Sharma, Shailesh Singh, Jaya Singh, Jagdamba Singh (2018) Organocatalytic mediated green approach: A versatile new L-valine promoted synthesis of diverse and densely functionalized 2-amino-3-cyano-4H-pyrans *Synth. Commun.* 10.1080/00397911.2017.1393087
- Deepali Jaiswal, Anu Mishra, Pratibha Rai, Madhulika Srivastava, Bhartendu P. Tripathi, Snehlata Yadav, Jaya Singh, Jagdamba Singh (2018) *Res. Chem. Intermed.*, 10.1007/s11164-017 3100-7
- Anu Mishra, Pratibha Rai, Jaya Singh and Jagdamba Singh (2018) A Visible-Light-Mediated Protocol: One-Pot-Three-Component, Sustainable Synthesis of 1,3,4-Thiadiazines. *ChemSelect* 10.1080/00397911.2017.1359844
- Amit K. Sharma, Jyoti Tiwari, Deepali Jaiswal, Shailesh Singh, Jaya Singh and Jagdamba Singh (2019) Organophotoredox Catalysis: Visible-light-induced Multicomponent Synthesis of Chromeno[4,3-b] chromene and Hexahydro-1H-xanthene *Current Organocatalysis* 6, 1-9.
- Manoj Kumar, Afreen Anjum, Sikandar Paswan and Raj Kumar Dubey (2018) Studies of Isopropoxide bridge Hetero-bimetallic complexes: Synthesis, spectral, morphology and Antimicrobial. *Bulletin of Pure & Applied Sciences- Chemistry*
- Raj Kumar Dubey, Sharad Kumar Mishra, Ashok Kumar Jha and Manoj Kumar (2018) Synthesis and physicochemical studies of cobalt(II), Nickel(II), Copper(II) complexes with various Schiff bases containing oxygen and nitrogen donor atoms. *J. Indian Chem. Soc.*
- Singh, V., Baranwal, K., Dwivedi, L.M., Shahala (2018) Guar gum mediated synthesis of NiO nanoparticles: An efficient catalyst for borohydride reduction of nitroarenes *Applied Nanoscience*
- Singh, V., Singh, J. Preeti Synthesis and characterization of Acacia gum-Fe⁰Np-Silica nanocomposite: An efficient Fenton-like catalyst for the degradation of Remazol Brilliant Violet dye *Applied Nanoscience*
- Singh, V., Joshi, S., Malviya T (2018) Carboxymethyl cellulose-Rosin gum hybrid nanoparticles: An efficient drug carrier *International Journal of Biological Macromolecules*
- 5-Aminosalicylic acid *International Journal of Biological Macromolecules*
- Singh, S., Tiwari, J., Jaiswal, D., Sharma, A., Singh, J., Singh, V (2018) Organocatalyst mediated one pot synthesis of 4H-furo[3,4-b]pyran, 4Hbenzo[g]chromene and 1H benzo[b]xanthene derivatives in aqueous medium: A green approach, *Current Organocatalysis* 10.2174/2213337205666180614113032
- Km Neha Shivhare, I. R. Siddiqui (2018) β -cyclodextrin mediated synthesis of indole derivatives: reactions of isatins with 2-amino(or 2-thiole) anilines by supramolecular catalysis in water *Supramolecular Chemistry* 10.1080/10610278.2018.1529315
- Km Neha Shivhare, Manish K. Shivhare, Anushree Srivastava, Saurabh K. Tiwari, I. R. Siddiqui (2018) Visible-light-activated C–C and C–N bond formation in the synthesis of imidazo[1,2-a]pyridines and imidazo[2,1-b]thiazoles under catalyst and solvent-free conditions *New Journal of Chemistry*
- Km Neha Shivhare, I. R. Siddiqui (2018) Chitosan: A Natural and Sustainable Polymeric Organocatalyst for C-C Bond Formation during the Synthesis of 5-amino-2,3-dihydrobenzo[d]thiazole-4,6-dicarbonitriles *Current Organocatalysis*
- Akhilesh Kumar, Pragati Rai, Vijay B. Yadav, I. R. Siddiqui (2018) Oligosaccharide assisted approach: An efficient and facile access to isochromeno[4,3-b]indoles derivatives in the presence of beta cyclodextrin, *Catalysis Letters*

- Akhilesh Kumar, Pragati Rai, Vijay B. Yadav, Hozeyfa Sagir, I. R. Siddiqui (2018) Malic acid as bioorganocatalyst: Sustainable, one-pot and multicomponent synthesis of Benzopyrimido[4,5-b]quinoline in biodegradable glycerol Current Organocatalysis
- Malik A Waseem, Rafiq A Rather, Mohammad Saquib, Afshan Ibad, Farah Ibad, Khursheed Ansari, M A Khuroo, Mohammed A. Assiri, I. R. Siddiqui (2018) [bmIm]Br catalyzed tandem construction of C–C and C–O bonds: A concise, convenient and atom-economical strategy for the synthesis of spiropyranopiperidine derivatives, New Journal of Chemistry
- Mohd Danish Ansari, Hozeyfa Sagir, Vijay B. Yadav, Neetu Yadav, I R Siddiqui (2018) Synthesis of Benzo[b]furan Derivatives via S₈-Nano particles/ β -cyclodextrin: An Environmentally Friendly Approach, Chemistry Select
- Neetu Yadav, Hozeyfa Sagir, Mohd. Danish Ansari, I. R. Siddiqui (2018) Visible-Light-Mediated Synthesis of 4H-benzo[1,4]thiazin-2-amines and 3,4-Dihydroquinoxalin-2-amines: An Efficient and Metal Free Route to C–S, C–N Bond Formation, Catalysis Letters
- Vijay B. Yadav, Pragati Rai, Hozeyfa Sagir, Akhilesh Kumar and I. R. Siddiqui (2018) A green route for the synthesis of pyrrolo[2,3-d]pyrimidine derivatives catalyzed by β -cyclodextrin, New Journal of Chemistry
- Khursheed Ansari, Ali Mohd Lone, Wajaht Amin Shah, Jagdamba Singh, I.R. Siddiqui (2018) Site selective [bmIm]OH catalyzed CC bond functionalization under green conditions, Tetrahedron Letters
- Narendra Kumar, Laxmi Kant Sharma, Abhishek Upadhyay, Rahul Dubey and R. K. P. Singh (2018) A Green electrochemical approach for synthesis of Oxa-bicyclo[2.2.1]hept-5-ene-2,3-dione derivatives Heterocyclic Letter
- Jyoti Malviya, R. K. P. Singh, Shashi Kala and L. K. Sharma (2018) Anodic Synthesis of New Benzofuran Derivatives Using Active Methylene Group at Platinum Electrode Russian J. Electrochemistry Vol. 54, No. 3, pp. 311–317
- Manjula Singh, Arvind K. Yadav, Lal Dhar S. Yadav, R. K. P. Singh (2018) Visible-light-activated selective synthesis of sulfoxides via thiol-ene/oxidation reaction cascade Tetrahedron Letters
- Manjula Singh, Arvind K. Yadav, Lal Dhar S. Yadav, R. K. P. Singh (2018) Direct synthesis of 6-sulfonylated phenanthridines via silver-catalyzed radical sulfonylation-cyclization of 2-isocyanobiphenyls Tetrahedron Letters
- Manjula Singh, Arvind K. Yadav, Lal Dhar S. Yadav, R. K. P. Singh (2018) Synthesis of 6-Thiocyanatophenanthridines by Visible Light and Air Promoted Radical Thiocyanation of 2-Isocyanobiphenyls SYNLETT
- Manjula Singh, Arvind K. Yadav, Lal Dhar S. Yadav, R.K.P. Singh (2018) K₂S₂O₈-Mediated Arylmethylation of Indoles with Tertiary Amines via sp³ C-H Oxidation in Water SYNLETT
- Anuradha Singh and Ramendra K. Singh (2018). Human Immunodeficiency Virus Reverse Transcriptase (HIV-RT): Structural Implications for Drug Development (published in the IGI Global book series Advances in Medical Technologies and Clinical Practice (AMTCP). (ISSN: 2327-9354; eISSN: 2327-9370).
- Vishal K. Singh, Himani Chaurasia, Richa Mishra, Vivek K. Chaturvedi, Vishal Srivastava and Ramendra K. Singh (2019). Natural Products as Anti-HIV Agents and their Role in HIV-Associated Neurocognitive Disorders (HAND).
- Subhash Chandra Shrivastava, Shailendra Badal, Rupali Sethi, J D Pandey and Shekhar Srivastava, *Compressional study of mercury through thermodynamic and thermoacoustical parameters* in Proceedings of 4th International Conference on academic research in engineering, management and information technology 2019 230-236 (2019).

DEPARTMENT OF DEFENCE AND STRATEGIC STUDIES

- Adhikari, S. (2019) authored “Dimensions of National Security”; Shabdarambh Prakashan, New Delhi
- Adhikari, S. (2019) authored “Yogi Aaditya Nath: From Spiritualism to Political Realism, Pentagon publication, New Delhi.
- Bhadauria, S. (2018) Co-authored “Rashtriya Suraksha: Siddhant aur Vyavhaar (National Security: Theory and Practice”); Prakash Book Depot, Bareilly (UP).
- Adhikari, S. (2019) authored “Rashtriya Suraksha Ke Ayam, RBU Publishing House, Prayagraj.
- Singh Ashish Vikram (2018) authored “ Bharat-Pakistan Sambandho Me Americi Niti, First Print Publication, Allahabad.

- Bhadauria, S. (2018) “Kashmir: Educated Youth Drifting Away” in Defence & Security Alert, Volume 9, Issue 07, April 2018, pp- 12-17
- Bhadauria, S. (2018) “India Myanmar Strategic Ties” in Defence & Security Alert, Volume 9, Issue 10, July 2018, pp -25-29
- Upadhyaya, R. K. (2018) “Low Intensity Conflict in Jammu and Kashmir” in Journal of Peace, Security & Development, Society for Peace, Security and Development studies, Prayagraj, Volume-XXII, pp-1-7
- Agarwal P. (2018) “Globalisation and National Security” in Journal of Peace, Security & Development, Society for Peace, Security and Development studies, Prayagraj, Volume-XXII, pp- 8-13
- Das B. (2018) “Role of Media and National Security” in Journal of Peace, Security & Development, Society for Peace, Security and Development studies, Prayagraj, Volume-XXII, pp- 14-19
- Verma Ashok Kumar (2018) “Bharat Ki Samudrik Kutiniti: Vartman Paridrishya in Jigyasa, Volume 11, issue -4, Dec. 2018, pp- 146-151
- Verma Ashok Kumar (2018) “Dakshin Asia Me Ruse China Pakistan Trikone Avam Bhartiye Surksha” in Sodhmanthan, Volume-9, issue - 4, Dec. 2018, pp 116-120
- Verma Ashok Kumar (2018) “Strings of Pearl Avam bharat-China Samudrik Surksha Pratispardha” in International Journal of Research And Analytical Review, Volume-5 issue-4, Nov. 2018, pp. 439-443.
- Verma Ashok Kumar (2018) “Bharat Ki Dakshin Asiayai Kutniti :Modi Ki Padosi Pratham Niti” in IJRAR, Volume-6, Issue-1, March 2019, pp-217-224
- Jaiswal Sakshi, (2018) “Energy Interests of India and China In Central Asia: India’s Energy Diplomacy Could Challenge China’s Monopoly,” in JETIR, Volume-5, Issue-4, pp. 818-820.
- Jaiswal Sakshi, (2018) “Geo Politics In Caspian Sea And Central Asian Region,” in IJRASET Volume- 6, Issue-4, pp.2264- 2267.
- Gupta Priyanshu (2018) “Women, Gender And Liberation Tamil Tigers of Eelam,” in International Journal of Research, Volume-5, Issue-12, pp. 2288-2296.
- Kumar Pradeep, (2018) “The Upsurge of Religious Extremism In Pakistan,” in IJCRT, Volume-6, Issue-2, pp. 365-368.
- Kumar Pradeep, (2018) “Pakistan Sponsored Terrorism: Security Threat to India,” in International Research Journal of Management Science and Technology, Volume-9, Issue-13, pp. 211-216.
- Kumar Pradeep, (2018) “Economy as a Factor in India’s Internal Security,” in CASIRJ, Volume-9, Issue-3, pp. 127-134.
- Singh Sonam, (2018) “Chabahar Port : A New Game For India And Golden Lane To Afghanistan And Central Asia,” in IJCRT, Volume-5, Issue-11, pp. 375-378
- Singh Sonam, (2018) “India, Pakistan, Afghanistan, and their Triangular Pestilent Relation” in CASIRJ, Volume-10, Issue-1, pp. 86-93.
- Singh Sonam, (2018) “South Asian Region Problems and Their Prospective” in IJRAR, Volume-6, Issue-1, pp. 1212-19.
- Singh Sonam, (2018) “Human Rights Content Threats and Prospective In Worlds scenario,” in CASIRJ, Volume-10, Issue-1, pp. 62-67.
- Singh sushil, (2018) “China’s Maritime Strategy And India’s Security Dilemma,” in Research Review International Journal Of Multidisciplinary, Volume-3, Issue-10, pp. 107-109.
- Singh sushil, (2018) “Naval Power In The Indian Ocean: Rivalry or Cooperation,” in IJR, Volume-5, Issue-12, pp. 2506-2516
- Yadav Alok kumar (2018) “Bharat Aasian Sambandho Me Purwottar Bharatki Bhumika,” in WWJMRD, Volume-4, Issue-3, pp. 232-34.
- Saumya Verma (2018) “New Dimension in South China Sea after the Verdict of Permanent Court of Arbitration,” in Online International Interdisciplinary Research Journal, Volume-9, Issue-04(Special), pp. 462-69.
- Bhadauria, S. (2018) ‘Bharat ki Rashtriya Suraksha evam Videsh Niti’ in S. K. Mishra Edited “Bhartiya Suraksha evam Videsh Niti”; Uday Publishing House, New Delhi, 2018, pp. 127 – 134 .

- Das B., Verma Kuldeep (2018) ‘Cyber Atankvaad aur Bharat ki Suraksha’ in Ajay Mohan Srivastava and others Edited “Bharat ke liye Khatre: Aantrik se Vaishvik”; University Publication, New Delhi, 2018, pp. 26 – 30
- Mourya Shivpoojan (2018) “China’s Role In India- Nepal Relation Concerns For India’s Security” in Dr. S.P.L. Srivastav and others Edited, “21vi Shatabdi Me Bharat Nepal Sambandh: Chunotiya Avam Viklp Pratyush Publication”, New delhi, pp. 384-397.
- Mourya Shivpoojan (2018) “Nepal Ka Badhata Pakistan Prem Bharat Ki Chintaye,” in Dr. S.P.L. Srivastav and others Edited. “India’s Nepal Relation In 21st Century Issues Challenges and Options”, Pratyush Publication, pp. 192-199
- Mourya Shivpoojan (2018) Bharat Ki Urja Surksha Sandarbh Me Bharat Japan Sahyog Ki Sambhawnaye, in Dr. Satish Chandra Pandey and others Edited, “Bharat Ki Apramparagat Surksha Chunaotiaya Aor Viklp.” Neel kamal Praksashan Delhi, Pp. 228- 231.

DEPARTMENT OF EARTH & PLANETARY SCIENCES

- Panthee S, Singh PK, Kainthola A, Das, R., Singh, T.N. (2018). Comparative study of the deformation modulus of rock masses—a reply to the comments received from Gokceoglu (2018). *Bulletin of Engineering Geology and Environment*, 77, 763–766.
- Kundu, J., Sarkar, K., Singh, P.K., Singh, T.N. (2018). Deterministic and Probabilistic Stability Analysis of Soil Slope – A Case Study. *Journal of Geological Society of India*, 91, 418–424.
- Panthee, S., Singh, P.K., Kainthola, A., Das, R., Singh, T.N. (2018). Comparative study of the deformation modulus of rock mass. *Bulletin of Engineering Geology and Environment*, 77, 751–760.
- Niyogi, A., Pati, J.K., Patil, S.K., Panda, D. and Chakarvorty, M. (2018) Magnetic measurements and geochemical characterization of the road-deposited sediments (RDS), Allahabad city, India: impact of climatic perturbations on sediment composition and provenance tracing. *Journal of Soils and Sediments (Springer)*, 18(7), 2581-2595. DOI:10.1007/s11368-018-1936-0).
- Niyogi, A., Pati, J.K., Panigrahi, M.K., Panda, D., Chakarvorty, M. and Parthasarathy, G. (2018) Raman, infrared and chemical characterization of fly ash-generated spherules. *Journal of Applied Spectroscopy (Springer)*, v. 85, No.5, 752-759.
- Pati, J.K., Reimold, W.U. and Hauser, N. (2018) Comment on “Anatomy of impactites and shocked zircon grains from Dhala reveals Paleoproterozoic meteorite impact in the Archean basement rocks of Central India” by Li et al., 2018. *Gondwana Research (Elsevier)*, 60, 214-217. DOI: 10.1016/j.gr.2018.03.019.
- Rai, A.K., Pati, J.K. and Kumar, R. (2019) Spectro-chemical study of moldavites from Ries impact structure (Germany) using LIBS. *Optics and Laser Technology (Elsevier)*, 114, 146-157.
- Alfimova, N., Matrenichev, V., Bogomolov, E., Nasipuri, P., Pati, J.K., Felitsyn, S., Saha, L., and Raza, M.B. (2019) Isotopic Sm-Nd signatures of Precambrian Banded Iron Formation from the Fennoscandian shield, East-European Platform and Bundelkhand craton, India. *Precambrian Research (In Production/Press, Elsevier, PRECAM_2018_318_R1)*.
- Singh, A.K., Tripathi, J.N., Singh, K.K., (2019). Weekly temporal resolution comparison of different satellite-derived rainfall with IMD gridded data over Indian Meteorological subdivisions during Indian summer monsoon 2016, *Journal of Hydrology*, doi.org/10.1016/j.jhydrol.2019.02.016
- Singh, A.K., Tripathi, J.N., Singh, K.K., Kotlia, B.S., Kumar, A., (2018). Monitoring groundwater storage over India during Indian Summer Monsoon (ISM) and Northeast (NE) monsoon systems using GRACE Satellite and GLDAS data: Impact on agriculture, *Quaternary International*, doi.org/10.1016/j.quaint.2018.10.036.
- Singh, A.K., Singh, V., Singh, K.K., Tripathi, J.N., Kumar, A., Soni, A.K., Sateesh, M., Khadke, C., (2018). A case study: Heavy rainfall event comparison between daily satellite rainfall estimation products with IMD gridded rainfall over peninsular India during 2015 winter monsoon., *Journal of the Indian Society of Remote Sensing*, 46(6):927–935 (doi.org/10.1007/s12524-018-0751-9).
- Singh, A.K., Singh, V., Singh, K.K., Tripathi, J.N., Kumar, A., Sateesh, M., Peshin, S.K., (2018). Validation of INSAT-3D derived rainfall estimates (HE & IMSRA), GPM (IMERG) and GLDAS 2.1 model rainfall product with IMD gridded rainfall & NMSG data over IMD’s Meteorological Sub-Divisions during Monsoon, *Mausam*, 69, 177-192.

- Mitra, A.K., Singh, A.K., Tripathi, J.N., Singh, Rao, V.K., Navria, K., and Sharma, A.K., (2019), Ground Site Suitability and its Characterization for INSAT-3D/R Cal/Val at IMD, Application of Remote Sensing, (Submitted).
- Singh P, Singh A K, Singh P, Kumari S, Sangaiah A K, 2018, Multimodel data modelling for efficiency assessment of social priority based urban bus route transportation system using GIS and data envelopment analysis. *Multimedia Tools and Applications* (Springer) <http://doi.org/10.1007/s11042-018-6147-6> , ISSN 1380-750 (print), 1573-7721 (online) , IF: 1.541, UGC List No. 31740
- Singh P, Kumar S, Singh P, 2018, Attenuation of short period body waves in North-western Himalayan region, India. *Soil Dynamics and Earthquake Engineering* (Elsevier) 114, 555-562, ISSN: 0267-7261, UGC List No. 36348
- Kumar S, Singh P, Singh P, Shekhar C, 2018, Estimation of scattering and intrinsic attenuation based on multiple lapse time window analysis in Sikkim Himalayan region, India, *Physics of the Earth and Planetary Interiors* (Elsevier) 284, 1-9, IF= 2.16, ISSN : 0031-9201, UGC List No. 30852.
- Singh P, 2018, Seismic energy and b-value for Garhwal Himalayas, India, *Disaster Advances*, 11(7),13-16, ISSN: 0974262x , UGC List No. 13226
- Singh P, Hasnat M, Singh P, 2018, Fuzzy criteria based recognition of groundwater prospective zones using GIS and remote sensing, *Disaster Advances*, 11(8), 1-10, ISSN: 0974262x , UGC List No. 13226
- Nasipuri, P., Saha, L., Xie, H., Pati, J.K., Satyanarayanan, M., Sarkar, S., Bhandari, A. and Gaur, Y. (2019) Paleoproterozoic crustal evolution of the Bundelkhand craton, north-central India. In: van Kranendonk, M., Bennett, V. and Hoffmann, J.E. (Eds.) *Earth's Oldest Rock* (2nd Edition), Elsevier, Amsterdam, 792-817.
- Singh, P.K., Kainthola, A., Singh, T.N., Tripathi, J.N. (2019). Rock Slope Monitoring Through Terrestrial LiDAR. *Proceedings of the Indian conference on Geotechnical and Geo-Environmental Engineering (ICGGE-2019)*. Paper 83, MNNIT Allahabad and Indian Geotechnical Society Allahabad Chapter, Prayagraj.

DEPARTMENT OF ELECTRONICS AND COMMUNICATION

J.K. Institute of Applied Physics & Technology, University of Allahabad

- Khare, A., Tiwary, U.S., Sethi, I.K., and Singh, N (2019), Recent Trends in Communication, Computing, and Electronics - Select Proceedings of IC3E 2018, Springer.
- P. Srivastava and A. Khare (2018) Content-based image retrieval using multiresolution Speeded-up robust feature. *International Journal of Computational Vision and Robotics*, 8 (4), 375-387
- P. Srivastava and A. Khare (2018) Utilizing multiscale local binary pattern for content-based image retrieval", *Multimedia Tools and Applications*, 77(10), 12377-12403
- P. Srivastava and A. Khare (2018) Content Based Image Retrieval using Local Binary Curvelet Co-occurrence Pattern - A Multiresolution Technique. *The Computer Journal*, 61(3), 369-385
- Gupta, S. K. Jha. (2019). Fast All Sum Algorithm over 2D-Mesh Network. *Recent Trends in Parallel Computing, STM Journal*, 5 (3), 37 – 43.
- Tiwari, D., Ansari, J. A., Siddiqui, M. G., and Saroj, A. K. (2018). Analysis of Modified Square Sierpinski Gasket Fractal Microstrip Antenna for Wireless Communications. *AEU- International Journal of Electronics and Communications*, vol. 94, pages 377-385.
- Siddiqui, M. G., Saroj, A. K., Devesh, and Ansari, J. A. (2018). Multi-Band Fractaled Triangular Microstrip Antenna for Wireless Applications. *Progress In Electromagnetics Research M*, vol. 65, 51–60.
- Siddiqui, M. G., Saroj, A. K., Saxena, R., Devesh, and Ansari, J. A. (2018). Design and Analysis of Microstrip Antenna Using RBF-NN for Multiband Operation. *I-manager's Journal on Electronics Engineering*, vol. 8, no. 3, pg 43-51.
- Rai S., Srivastava R. (2018). Implementation of Exponential Functions on FPGA Device Using Hyperbolic CORDIC Processor. *i-manager's Journal on Digital Signal Processing, Enabling Technology for the generation and interpretation of information*, vol.6, no.1, pp. 21-27.
- Rai S., Srivastava R. (2018). Implementation of Digital Filters in Programmable Logic Devices based on Scale Free Hyperbolic CORDIC Processors. *Int. Journal of Research in Electronics and Computer Engineering*, vol.6(3),pp. 1623-1629

- Shukla N. K., Srivastava R. (2018). Efficiency Optimization of Single Phase Induction Motor Using Semiconductor Devices. *Int. Journal of Electronics, Electrical and Computational System*, vol.7(4), pp. 47-54, 2018.
- Sahoo, S. K Jha, D. A. Khan (2018). An Energy Efficient Approach to Reduce Communication Payload in Sensor Nodes. *Proc. of International Conference on Advances in Science & Technology*. pp. 1-8, SKIT, Jaipur
- N. T. Binh, P. B. Quoc, T. T. Dang and A. Khare (2019). Skelton formation from human silhouette images using joint points estimation. *Proc. of 2018 Second International Conference on Advances in Computing, Control and Communication Technology*, pp. 101-105, Allahabad, India
- Reddy Mounika, Om Prakash and Ashish Khare, "Key-frame extraction using uniform local binary pattern", in proc. of 2018 Second International Conference on Advances in Computing, Control and Communication Technology (IAC3T 2018), 21-23 September, 2018, Allahabad, India, pp. 87-91,
- T. K. K. Ho, J. Gwak, C. M. Park, A. Khare, J. Song (2018) Deep Learning-Based Approach for Mental Workload Discrimination from Multi-channel fNIRS", *International Conference on Emerging Trends in Communication, Computing and Electronics*, Allahabad, India, pp. 431-440
- R. Mounika, O. Prakash, A. Khare (2018). Fusion of Zero-Normalized Pixel Correlation Coefficient and Higher-Order Color Moments for Keyframe Extraction. *International Conference on Emerging Trends in Communication, Computing and Electronics*, Allahabad, India, pp. 357-364
- S. Lee, J. Gwak, O. Prakash, M. Khare, A. Khare, M. Jeon (2018). Comparative Study on Person Re-identification Using Color and Shape Features-Based Body Part Matching *International Conference on Emerging Trends in Communication, Computing and Electronics*, Allahabad, India, pp. 313-322
- Kushwaha, O. Prakash, R. K. Srivastava, A. Khare (2018). Dense Flow-Based Video Object Segmentation in Dynamic Scenario *International Conference on Emerging Trends in Communication, Computing and Electronics*, Allahabad, India, pp. 271-278
- V. Rathore, A. Verma, A. Kumar, A. K. Pal. (2018). Map based Cryptosystem for VQ based Compressed Video data. *Proceedings of 3rd International Conference on Internet of Things and Connected Technologies* pp. 1-6, MNIT Jaipur.
- P. Srivastava, A. Khare (2019). Content-Based Image Retrieval Using Multiresolution Feature Descriptors", in *Recent Advances in Computer Vision - Theories and Applications, in Studies in Computational Intelligence*, Chapter 9, pp. 211-235, Springer.
- S. Singh, T. J Siddiqui, (2018). Transform domain techniques for image steganography, *Computer Vision: Concepts, Methodologies, Tools, and Applications*, pp. 170-186, IGI Global
- S. Singh, R. Singh, A. K. Singh, T. J Siddiqui (2018). SVD-DCT based medical image watermarking in NSCT domain. *Quantum Computing: An Environment for Intelligent Large Scale Real Application*. pp.467- 488 Springer, Cham
- M. Jaiswal, A. Srivastava, T. J Siddiqui (2019). Machine Learning Algorithms for Anemia Disease Prediction. *Recent Trends in Communication, Computing, and Electronics*, pp. 463-469 Springer, Singapore
- Rai S., Srivastava R. (2019) FPGA Realization of Scale-Free CORDIC Algorithm-Based Window Functions. In: Khare A., Tiwary U., Sethi I., Singh N. (eds) *Recent Trends in Communication, Computing, and Electronics. Lecture Notes in Electrical Engineering*, vol 524. Springer, Singapore.

DEPARTMENT OF HOME SCIENCE

- Gupta E., Shakyawar S and Sundaram S. (2018) Phytochemical and Nutraceutical properties of *Aegle marmelos* (L.): An Overview. *Current Nutrition and Food Science*; 14 (12) 1-12.
- KESARWANI P., SHARMA S.K., KESARWANI K. (2018) ENTREPRENEURSHIP OF RURAL WOMEN BY VALUE ADDITION OF UNCONVENTIONAL FIBERS IN COMPOUND BOOK ENTITLED WOMEN IN SUSTAINABLE DEVELOPMENT, 1ST EDITION RBSA PUBLISHERS, JAIPUR. 93-98P.
- Srivastava R , Mishra N , Agarwal S and Mishra N (2019) Pharmacological and Phytochemical properties of Kaitha (*Feronia limonia* L.) : A Review, *Plant Archives* Vol. 19, Supplement 1, 2019 pp. 608-615.
- Sureka R. (2018). Spousal Violence against women: Providing the Grassroots Perspective. *Sociology of Social Behavior* (ed. Dr. Sukanta Sarkar, Dr. Saidur Rahman, Dr. Md. Afsar Alam). New Delhi: Global Vision Publishing House, pp. 83-93.

- Sureka R. (2019) "A Comparative Study On The Prevalence Of Domestic Violence Among Rural And Urban Dalit Women Of Prayagraj (Allahabad) District" author by "Ritu K. Sureka, Anjali Mathur, Anshu and Nisha Chacko" International Journal of Applied Social Science, Volume 6 Issue 3 .
- Agrawal S., Srivastava R., Mishra N. (2019). An overview of therapeutic potential of thymoquinone. International Journal of Pharmaceutical Sciences and Research, 10 (8): 1000-08.
- Mishra N., Kaur D and Mishra N (2019). Bioactive potential of microalgae as future food (edited by I Chakraborty, R ilahy and B Vikram). Satish serial publishing house Delhi (India).
- Puranik V., Khushwaha R., Mishra N and Kaur D. (2019). Valorization of Tomato Processing Waste: An Industrial Perspective (edited by I Chakraborty, R ilahy and B Vikram). Satish serial publishing house Delhi (India).
- Gupta E., Maurya NK. (2019). "Foodborne Illness: Pathogens and Diseases", accepted for publication in edited book titled "Recent Trends in Food Technology and Nutrition (Volume – 8)".

DEPARTMENT OF MATHEMATICS

- Deo, S. and Ansari, I. A. (2018). Magnetohydrodynamic viscous fluid flow past a porous sphere embedded in another porous medium. Special Topics and Reviews in Porous Media, 9(2), 191-200.
- Devi, S. and Gupta, N. (2018). Dynamics of Carbon Dioxide Gas (CO₂): Effects of Varying Capability of Plants to Absorb CO₂. Natural Resource Modelling, 32(1), DOI: 10.1111/nrm.12174.
- Devi, S. and Gupta, N. (2018). Logistic growth vs regrowth model with delay for the harvesting of vegetation biomass with its effects on CO₂. Nonlinear Studies, 25 (2), 315-332.
- Devi, S. and Gupta, N. (2019). A Mathematical Model to Analyze the Dependence of Biomass on the Concentration of CO₂. International Journal of Ecology and Development, 34 (1), 15-24.
- Prakash, S. and Chaturvedi, A.K. (2019). Iso-Noetherian Rings and Modules. Communications in Algebra, 47(2), 676-683.
- Chaturvedi, A.K. (2019). Iso-retractable Modules and Rings. Asian European Journal of Mathematics. 12(1), 1950013-19.

DEPARTMENT OF PHYSICS

- Shiva Sharma, Pratima Chauhan, (2018), Influence of PH variation on Optical and Structural properties of ZnO Nanoparticles, Advanced Science, Engineering and Medicine, Vol. 10, 805–809, 2018, DOI: 10.1166/asem.2018.2210, 1532-2289
- Pratima Chauhan, Deepika Gupta, (2018), Toxicity of Silver Nanoparticles on Wheat Seedlings, Advanced Science, Engineering and Medicine Vol. 10, 828–830, 2018, 1532-236X
- Monika Tandon and Pratima Chauhan, (2018), Effect of solvent medium on Structural and Optical Properties of ZnO-SnO₂ Nanocomposite., Adv. Sci. Eng. Med. (2018). Vol. 10, 750–754, 2164-6627
- Mini Mishra and Pratima Chauhan, (2018), Growth inhibitory effect of silver nanoparticle against Pseudomonas aeruginosa, IJETAE, ISSN: 22502459, vol. 8(4), 2250-2459
- Zainab Gazali, S.N. Thakur, and A.K. Rai, (2018), Compositional study of gallbladder stone using photoacoustic spectroscopy, Optics and Laser Technology, Optics and Laser Technology, ISSN: 0030-3992
- Ashok Pathak, Nilesh Rai, Rohit Kumar, Pradeep Rai, Awadhesh Rai, Christian Parigger, (2018), Gallstone magnesium distributions from optical emission spectroscopy, Atoms, Atoms Volume 6, Issue 42, 2218-2004
- Pravin Kumar Tiwari, Shikha Awasthi, Rohit Kumar, Raj Kumar Anand, Pradeep Kumar Rai, and Awadhesh Kumar Rai, (2018), Rapid analysis of pharmaceutical drugs using LIBS coupled with multivariate analysis, Lasers, Laser in Medical Science, Volume 33, Issue 2, 263-270, 1435-604X
- K. Pathak, Ankita Singh, Rohit Kumar and A. K. Rai, (2018), Laser-Induced Breakdown Spectroscopy Coupled with PCA Study of Human Tooth, Natl. Acad. Sci. Lett, ISSN 2250-1754
- Sweta Sharma, Nidhi Shukla, Abhi Sarika Bharti, and K N Uttam, (2018), Simultaneous multielemental analysis of the leaf of Moringa oleifera by direct current arc optical emission spectroscopy, National Academy Science letters, 41, 65–68, 978-93-85149-24-5
- Sweta Sharma, Rahul Uttam, Praveen Singh and K N Uttam, (2018), Detection of vibrational spectroscopic biomarkers of the effect of gold nanoparticles on wheat seedlings using attenuated total reflectance Fourier transform infrared spectroscopy, Analytical Letters, 51, 2272-2294, 978-93-85149-24-5

- Abhishek Shukla, Abhishek K. Bhardwaj, S.C Singh, K. N. Uttam, Nisha Gautam, A. K. Himanshu, Jyoti Shah, R. K. Kotnala and R. Gopal, (2018), Microwave assisted scalable synthesis of titanium ferrite nanomaterials, *Journal of Applied Physics*, 123, 161411, 978-93-85149-24-5
- Sweta Sharma and K.N. Uttam, (2018), Early stage detection of stress due to copper on Maize (*Zea mays L.*) by infrared and fluorescence spectroscopy, *Journal of Applied Spectroscopy*, 85, 771-780, 2250-1754
- Abhi Sarika Bharti, Sweta Sharma, Nidhi Shukla and K. N. Uttam, (2018), Steady state and time resolved laser-induced fluorescence of garlic plants treated with titanium dioxide nanoparticles, *Spectroscopy Letters*, 51, 45-54, 1532-236X
- Sweta Sharma and K.N.Uttam, (2018), Early diagnostic of mercury stress on wheat seedlings using attenuated total reflection Fourier transform infrared spectroscopy, *Analytical Letters*, 51, 1544-1563, 1089-7550
- Abhishek Kumar Bhardwaj, Abhishek Shukla, Shweta Maurya, Subhash Chandra Singh, Kailash N Uttam, Shanthi Sundaram, Mohan P Singh, Ram Gopal, (2018), Direct sunlight enabled photo-biochemical synthesis of silver nanoparticles and their Bactericidal Efficacy: Photon energy as key for size and distribution control, *Journal of Photochemistry and Photobiology B: Biology*, 188, 42-49, 1532-2289
- Sweta Sharma and K. N. Uttam, (2018), Nondestructive and rapid probing of biochemical response of arsenic stress on the leaves of wheat seedlings using attenuated total reflectance Fourier transform infrared spectroscopy, *Analytical Letters*, 2250-1754
- Sweta Sharma, Rahul Uttam, Abhi Sarika Bharti, Nidhi Shukla and K.N. Uttam, (2018), Label free mapping of the biochemical in Tomato fruit by Confocal Raman Microspectroscopy, *National Academy of Science Letters*, 1011-1344
- Mini Mishra and Pratima Chauhan, (2018), Plant Mediated Synthesis of Silver Nanoparticles and Antifungal Assay, *Advanced Science, Engineering and Medicine* Vol. 10, 684–688, 2250-1754
- Pooja Dwivedi and Pratima Chauhan,, (2018), Comparative study of pure and Cd-doped ZnS nanoparticles synthesized by wet chemical method, *Adv. Sci. Eng. Med.* (2018). Vol. 10, 755–758, 2164-6627
- Raj kakamal and yadav, Pratima Chauhan, (2018), Effect of Co doping on structural and optical properties of ZnO nanoparticles, *Adv. Sci. Eng. Med.* (2018). Vol. 10, 675–680, 20182164-6627
- Mini Mishra and Pratima Chauhan, (2018), Antimicrobial investigation of silver doped TiO₂ nanoparticle, *IJARSE, ISSN-2319-8354*., Vol. 7(5), 2319-8354
- Mini Mishra and Pratima Chauhan, (2018), Evaluation of antibacterial behaviour of silver nanoparticle, *Int. J. Adv.Res.* 6(3), 1062-1067, 2320-5407
- Shiva Sharma, Pratima Chauhan, Shahid Husain, (2018), Liquefied petroleum gas sensor based on manganese (III) oxide and zinc manganese (III) oxide nanoparticles, *Materials Research Express*, vol. 5, pp-015014, 2018 - iopscience.iop.org, 2053-1591
- R. K. Anand, (2018), On the Strong Spherical Shock Waves in a Two-Phase Gas–Particle Medium, *Int. J. Appl. Comput. Math* 4 49 (14pp, 2349-5103
- Jaiswal, A.K., Yadawa, P.K. and Yadav, R.R., (2018), Ultrasonic Wave Propagation in Ternary Intermetallic CeCuGe Compound, *Ultrasonics* 89, 22-25, 0041-624X
- Sivakumar, N., Jayavel, R., Anbalagan, G., Yadav, R.R, (2018), Synthesis, growth, spectral, electrical, mechanical and thermal characterization of a potential optical material: γ -glycine single crystal, *Optical Materials*, 80, 177-185, 0925-3467
- Ram Kripal and Awadhesh Kumar Yadav, (2018), Calculation of [g] Tensor of 3d9 Complexes on the Basis of Molecular Orbital Theory, *Int. J. Modern Phys. Appl.* 5(2018)11-14, 2375-3870
- Ram Kripal and UpendraMani Tripathi, (2018), A Comprehensive Spectroscopic Study of Mn²⁺ doped PbS nanocrystals, *JMSE*, 0857-4522
- Abhishek Shukla, AK Bhardwaj, SC Singh, KN Uttam, N Gautam, AK Himanshu, J Shah, RK Kotnala, R Gopal, (2018), Microwave Assisted Scalable Synthesis of Titanium Ferrite Nanomaterials, *Journal of Applied Physics* 123 (2018) 161411, 1089-7550
- Abhishek K Bhardwaj, A. Shukla, S Maurya, S.C. Singh, K.N. Uttam, S Sundarm and R. Gopal, (2018), Direct Sunlight enables photo-biochemical synthesis of Ag NPs and their bacterial efficiency: Photon energy as a key for size and distribution control, *J Photochem and Photobio B* (2018) JPB_11337, 1011-1344

- Asheel Kumar, (2018), Nonlocal effects in Weibel instability and two stream instability in a plasma, *Optik* 178, pp. 251-255, 0030-4026
- Asheel Kumar, (2018), X- mode coupling to Bernstein wave in a plasma embedded with clusters , *Optik* 178, pp.602 - 609, 0030-4026
- Shiv P. Patel, J. C. Pivin, G. Maity, R. P. Yadav, R. Chandra, D. Kanjilal, Lokendra Kumar , (2018), Microstructural and surface morphological studies on Co doped ZnS diluted magnetic semiconductor thin films, *Journal of Materials Science: Materials in Electronics*, 0957-4522
- Sweta Sharma, Abhi Sarika Bharti, M. K. Tiwari & K. N. Uttam, , (2018), Effect of manganese stress on the mineral content of the leaves of wheat seedlings by use of X-ray fluorescence excited by synchrotron radiation, *Spectroscopy Letters*, 514, 302-310, 1532-236X
- Pravin Tiwari, Shweta Gaur, Abhimanyu K Singh, Vijay P Singh, Devendra K Chauhan, Naleeni Ramawat; Awadhesh K Rai, Sheo M Prasad, (2019), Liquid assisted pulsed laser ablation synthesized copper oxide nanoparticles (CuO-NPs) and their differential impact on rice seedlings, *Ecotoxicology and Environmental Safety*, 76, 321-329., <https://doi.org/10.1016/j.ecoenv.2019.01.120>
- Dubey Prachee , Tiwari Ayushi , Tiwari Praveen , Awasthi Shikha , Rai A K , Watal Geeta, (2019), Phytochemical and Phytoelemental Profile of J. , *International Journal of Pharmacognosy and Phytochemical Research*; 11(1);5-9, 0975-4873
- Ayushi Tiwari, Prachee Dubey, Pravin Kumar Tiwari, Geeta Watal and A.K. Rai, (2018), Impact of Phytochemicals and Phytoelements on Therapeutic Attributes of A. Esculentus Leaves: A LIBS Based Study, *J. Biol. Chem. Research*. Vol. 35, No. 2: 427-433,
- Rohit Kumar, Alamelu Devanathan, Nand Lal Mishra and Awadhesh Kumar Rai, (2018), Quantification of Heavy Metal Contamination in Soil and Plants near Leather Tanning Industrial Area using LIBS and TXRF , *J Appl. Spectro.*, Vol. 86, No. 5
- Singh V, Kumar S, Rai A K, (2018), Sensory analysis of bar samples prepared from mahua (*Madhuca longifolia*) flower syrup using fuzzy logic, *Nutrafoods* 17, 137-144. DOI 10.17470/NF-018-1010-3
- Sweta Sharma, Rahul Uttam, Abhi Sarik Bharti, and K. N. Uttam, (Accepted (2018)), Interaction of Zinc Oxide and Copper Oxide Nanoparticles with Chlorophyll: A Fluorescence Quenching Study, *Analytical Letters*, <https://doi.org/10.1080/00032719.2018.1556277>
- Sweta Sharma, Abhi Sarika Bharti, Renu Singh, and K. N. Uttam, (Accepted (2018)), Non-destructive Phenotyping of Chili Pepper Ripening Using Spectroscopic Probes: A Potential Approach for Shelf-Life Measurement, *Analytical Letters* <https://doi.org/10.1080/00032719.2018.1558231>
- Sweta Sharma and K. N. Uttam, (2019), Non destructive and Rapid Probing of Biochemical Response of Arsenic Stress on the Leaves of Wheat Seedlings Using Attenuated Total Reflectance Fourier Transform Infrared Spectroscopy, *Analytical Letters*, 52, 268-287
- Sweta Sharma, K.N. Uttam, (2019), Non-destructive and rapid interrogation of biochemical response of the leaves of wheat seedlings towards Al₂O₃ nanoparticles stress using attenuated total reflectance Fourier transform infrared spectroscopy, *Vibrational Spectroscopy*, *Vibrational Spectroscopy* 100, 142–151
- Sweta Sharma, Rahul Uttam, Abhi Sarika Bharti, Nidhi Shukla and K.N. Uttam, (2019), Label Free Mapping of the Biochemical in Tomato Fruit by Confocal Raman Microspectroscopy, *National Academy of Science Letters*, doi: <https://doi.org/10.1007/s40009-018-0747-6>
- R K Anand and H C Yadav, (2019), Spherical shock waves of variable energy in a radiating atmosphere , *Physics Journal* Vol 2 , 264-281
- Abhi Sarika Bharti, Sweta Sharma, Nidhi Shukla, M.N. Deo and K. N. Uttam, (2018), Non-destructive, label free evaluation of biochemical signatures of fleshy layers of the onion bulb by FT-Raman spectroscopy, *Proceedings of National Laser Symposium (NLS-27)*, RRCAT, Indore, 03-06 Dec, 2018
- Sweta Sharma, Abhi Sarika Bharti, Rahul Uttam, Renu Singh, and K N Uttam, (2018), Nondestructive label free evaluation of spectral signature of ripening process of mesocarp of mango fruit using confocal Raman microspectroscopy, *Proceedings of National Laser Symposium (NLS-27)*, RRCAT, Indore, 03-06 Dec, 2018
- Abhi Sarika Bharti, Sweta Sharma, Nidhi Shukla, M.N. Deo and K. N. Uttam, (2018), Non-destructive, label free evaluation of biochemical signatures of fleshy layers of the onion bulb by FT-Raman spectroscopy, *Proceedings of National Laser Symposium (NLS-27)*, RRCAT, Indore, 03-06 Dec, 2018

- Rahul Uttam, Sweta Sharma, S. R. Vishwakarma, Himal Bhatt, M.N. Deo, Renu Singh and K. N. Uttam, (2018), Nondestructive and Label Free Evaluation of Alterations in the Biochemicals during Roasting of Peanuts by Fourier Transform Infrared Microspectroscopy, Presented in 7th International Conference on Perspectives in Vibrational Spectroscopy, Organized by Bhabha Atomic Research Centre, Mumbai, 5Abstract no. 59, November 25-29, 2018
- Sweta Sharma and K N Uttam, (2018), Non-destructive and rapid interrogation of biochemical response of the leaves of wheat seedlings towards Al₂O₃ nanoparticles stress at an early stage using attenuated total reflectance Fourier transform infrared spectroscopy, Presented in 7th International Conference on Perspectives in Vibrational Spectroscopy, Organized by Bhabha Atomic Research Centre, Mumbai, Abstract no. 94, November 25-29, 2018
- Abhi Sarika Bharti, Sweta Sharma, Nidhi Shukla, S.R. Vishwakarma, M.N. Deo and K. N. Uttam, (2018), Investigation of biochemical spectral signatures of the leaves of the Coriander and Mentha plants by vibrational spectroscopy, Presented in 7th International Conference on Perspectives in Vibrational Spectroscopy, Organized by Bhabha Atomic Research Centre, Mumbai, November 25-29, 2018, Abstract no. 92
- Abhi Sarika Bharti, Sweta Sharma, Nidhi Shukla, S.R. Vishwakarma, M.N. Deo and K. N. Uttam, (2018), Investigation of biochemical spectral signatures of the leaves of the Coriander and Mentha plants by vibrational spectroscopy, Presented in 7th International Conference on Perspectives in Vibrational Spectroscopy, Organized by Bhabha Atomic Research Centre, Mumbai, November 25-29, 2018, Abstract no. 92
- Abhi Sarika Bharti, Sweta Sharma and K. N. Uttam, (2018), Potential of attenuated total reflectance Fourier transform infrared spectroscopic technique for the analysis of the impact of copper oxide nanoparticles on the biochemical of the garlic plant, Presented in 7th International Conference on Perspectives in Vibrational Spectroscopy, Organized by Bhabha Atomic Research Centre, Mumbai, November 25-29, 2018, Abstract no. 93
- Abhi Sarika Bharti, S.R. Vishwakarma, Himal Bhatt, M.N. Deo and K. N. Uttam, (2018), Fourier transform infrared microspectroscopic study of the chemical structure of gallstones, Sweta Sharma, Presented in 7th International Conference on Perspectives in Vibrational Spectroscopy, Organized by Bhabha Atomic Research Centre, Mumbai, November 25-29, 2018, Abstract no. 68
- Nidhi Shukla, Himal Bhatt, S.R. Vishwakarma, M.N. Deo and K. N. Uttam, (2018), Nutritional evaluation of biochemicals in green okra (*Abelmoschus esculentus*) by non-destructive vibrational spectroscopy (FT-Raman and ATR-FTIR), Presented in 7th International Conference on Perspectives in Vibrational Spectroscopy, Organized by Bhabha Atomic Research Centre, Mumbai, November 25-29, 2018, Abstract no. 60
- Aarti Jaiswal, Sweta Sharma, Abhi Sarika Bharti and K N Uttam, (2019), Green synthesis and optical characterization of the silver nanoparticles and its applications, Presented in National Seminar in Future India: Science and technology, Organized by Allahabad Chapter, Indian Science Congress, Department of Chemistry, University of Allahabad, February 22-24, 2019, Abstract no. Phy 02
- Chhavi Bran, Sweta Sharma, Abhi Sarika Bharti and K N Uttam, (2019), Fascinating world of floral pigments: Investigation by Confocal Raman microscopy, Presented in National Seminar in Future India: Science and technology, Organized by Allahabad Chapter, Indian Science Congress, Department of Chemistry, University of Allahabad, February 22-24, 2019, Abstract no. Inter 7
- Sweta Sharma and K.N.Uttam, (2019), Prompt screening of the alterations in biochemical and mineral profile of wheat plants stressed with chromium using attenuated total reflectance Fourier transform infrared spectroscopy and X-ray fluorescence excited by synchrotron radiation, Presented in National Seminar in Future India: Science and technology, Organized by Allahabad Chapter, Indian Science Congress, Department of Chemistry, University of Allahabad, February 22-24, 2019, Abstract no. B 18
- Aradhana Tripathi, Sweta Sharma, Abhi Sarika Bharti and K N Uttam, (2019), Investigation of the interaction of carotenoid with titanium dioxide nanoparticles: A fluorescence quenching study, Presented in National Seminar in Future India: Science and technology, Organized by Allahabad Chapter, Indian Science Congress, Department of Chemistry, University of Allahabad, February 22-24, 2019, Abstract no. Phy 01
- Abhi Sarika Bharti, Sweta Sharma, M. N. Deo and K. N. Uttam, (2019), Non-destructive, label free, rapid interrogation of phytochemical profile of the plant tissue of the medicinal plant by FT-Raman spectroscopy, Presented in National Seminar in Future India: Science and technology, Organized by Allahabad Chapter, Indian Science Congress, Department of Chemistry, University of Allahabad, February 22-24, 2019, Abstract no. Inter 1

DEPARTMENT OF STATISTICS

- Pundir, P. S., & Gupta, P. K. (2018). Reliability Estimation in Load-Sharing System Model with Application to Real Data. *Annals of Data Science*, 5(1), 69-91.
- Pundir, P. S., Patawa, R., & Gupta, P. K. (2018). Stochastic outlook of two non-identical unit parallel system with priority in repair. *Cogent Mathematics & Statistics*, 5(1), 1467208.
- Pundir, P. S., & Gupta, P. K. (2018). Analysis of Hybrid Censored Competing Risks Model with Bathtub-Shaped Failure Time Distribution. *Journal of Statistics Applications & Probability Letters*, 5(2), 63-72.
- Pundir, P. S., Singh, A., Singh, G.P., & Verma, A. (2018). Modelling and Forecasting Age-Specific Mortality Rates in India. *World Wide Journal of Multidisciplinary Research and Development*, 4(1), 113-116.
- Pundir, P. S., & Gupta, P. K. (2018). Stress-Strength Reliability of Two-Parameter Bathtub-Shaped Lifetime Model Based on Hybrid Censored Samples. *Journal of Statistics & Management Systems* (Accepted).
- Jitendra Kumar, Umme Afifi and Anoop Chaturvedi (2018). Bayesian analysis of unit root testing for panel data time series model in the presence of time effect, *Pakistan Journal of Statistics*, 34 (5), 381-396.
- Badi H. Baltagia, Georges Bresson, Anoop Chaturvedi and Guy Lacroix. (2018) Robust linear static panel data models using e-contamination, *Journal of Econometrics*, 2018, 202 108-123, 2018. ISSN: 0304-4076.

DEPARTMENT OF ZOOLOGY

- Ghosh, S.N., Rai, S.K., Pandey, R.S. and Haldar, C. (2018) – Reproduction and energy budget in goats – In: *Xenobiotics, Environment and Functional Biology* (Serajuddin, M., Amjad, M. and Agarwal, P. eds.) Ch. 9, pp 61-68, Amiga Press Inc., Delhi.
- Ghosh, S.N., Rai, S.K., Pandey, R.S. and Haldar, C. (2018) – Experiments with goats: Limitations and challenges - In: *Xenobiotics, Environment and Functional Biology* (Serajuddin, M., Amjad, M. and Agarwal, P. eds.) Ch. 10, pp 69-72, Amiga Press Inc., Delhi.
- Ghosh, S.N., Rai, S.K., Pandey, R.S. (2018) – Synthesis, characterization and evaluation of physiolouse in osteoporosis impacts of melatonin loaded Poly (D,L-Lactic acid) nanoparticles (Mel-Pla-N-nanoparticles and its putative) – In: *Xenobiotics, Environment and Functional Biology* (Serajuddin, M., Amjad, M. and Agarwal, P. eds.) Ch. 11, pp 73-80, Amiga Press Inc., Delhi.
- Singh K. P., Verma N. (2019). Teratogenic potential of third-generation antiepileptic drugs: Current status and research needs. *Pharmacological Reports*, 17(3):491-502 (Elsevier) IF: 2.801
- Singh, U., Singh, S., Tiwari, R.K. and Pandey, R.S. (2018) - Water pollution due to discharge of industrial effluents with special reference to Uttar Pradesh, India: A Review – *Internatl. Archive Appl. Sci. Tech.* 9 (4): 111-121.
- Singh S. K., Hidau M. K., Gautam S., Gupta K., Singh K. P., Singh S. K. & Singh S. (2018). Glycol chitosan functionalized asenapine nanostructured lipid carriers for targeted brain delivery: Pharmacokinetic and teratogenic assessment. *International Journal of Biological Macromolecules*, 108, 1092-1100. (Elsevier) IF: 3.90
- Singh, K. P. & Gupta K. (2018). Teratogenic effects of third-generation antiepileptic drug, pregabalin: an in vivo study. *Current Drug Safety*, 13(2), 113-121. (Bentham Science)
- Singh, S., Tiwari, R.K. and Pandey, R.S. (2018) - Evaluation of acute toxicity of triazophos and deltamethrin and their inhibitory effect on AChE activity in *Channa punctatus* - *Toxicology Reports* – 5: 85-89.
- Tiwari, R.K., Singh, S. and Pandey, R.S. (2019) – Assessment of acute toxicity and biochemical responses to Chlorpyrifos, cypermethrin and their combination exposed earthworm, *Eudrilus eugeniae* - *Toxicology Reports* 6: 288-297
- Singh, S., Tiwari, R.K. and Pandey, R.S. (2019) - Acute toxicity evaluation of triazophos, deltamethrin and their combination on earthworm, *Eudrilus eugeniae* and its impact on AChE activity - *Chemistry and Ecology* Doi:10.1080/02757540.2019.1600697 (Impact factor 1.091)
- Singh, U., Tiwari, R.K. and Pandey, R.S. (2019) - Physicochemical characteristics of fertilizer industry effluent and its toxicological impact on the activity of Acetylcholinesterase (AChE) in a freshwater teleost, *Heteropneustes fossilis* and *Labeo rohita* - *Croatian Journal of Fisheries* – (accepted).
- Gaur, S.K. and Kumar, K. (2019). Sensitivity of tobacco caterpillar, *Spodoptera litura*, to extract from a medicinal plant, *Withania somnifera*. *International Journal of Vegetable Science* (Taylor & Francis), doi.org/10.1080/19315260.2019.1605556.

- Gaur, S.K. and Kumar, K. (2019). A comparative bioefficacy of seed and root extracts of a medicinal plant, *Withania somnifera* when administered to prepupae of lepidopteran insects, *Spodoptera litura* (Lepidoptera: Noctuidae) and *Pericallia ricini* (Lepidoptera: Arctiidae). *The Journal of basic and Applied Zoology* (Springer) (Accept), DOI: 10.1186/s41936-019-0107-1.

CENTRE OF BIOTECHNOLOGY

- Chaturvedi, V.K., Singh, A., Dubey, S.K., Hetta, H.F., James, J. and Singh, M.P. (2019) *Molecular mechanistic insight of hepatitis B virus mediated hepatocellular carcinoma. Microbial Pathogenesis* 128: 184-194 49.
- Chaturvedi, V.K., Singh, A., Singh, V.K. and Singh, M.P. (2018) *Cancer Nanotechnology: A New Revolution for Cancer Diagnosis and Therapy. Curr Drug Metab.*
- Ramteke, P.W., Sagar, A. and Singh, M.P. (2019) Assessment of wastewater toxicity by *Vibrio fischeri* bioassay. *Int. J. Ecol. Environ, Sci.* 45 (1): 15-17.
- Bhardwaj, A.K., Shukla, A., Maurya, S. Singh, S.C., Uttam, K.N., Sundaram, S., Singh, M.P. and Gopal, R. (2018) Direct sunlight enabled photo-biochemical synthesis of silver nanoparticles and their Bactericidal Efficacy: Photon energy as key for size and distribution control. *J. Photobiol.* 188: 42-49.
- Chaturvedi, V.K., Agarwal, S., Gupta, K.K., Ramteke, P.W. and Singh MP (2018) Medicinal mushroom: boon for therapeutic applications. *3 Biotech* 8:334.
- V.K. Chaturvedi, D. Mishra, A. Tiwari, Snijesh VP, Noor A. Shaik and M.P. Singh. (2019). Sequence Databases. Understanding Bioinformatics: Essentials of Bioinformatics Volume I, Understanding Bioinformatics: Genes to Proteins. *Springer Nature Switzerland*, eISBN: 978-3-030-02634-9, pISBN: 978-3-030-02633-2, DOI: 10.1007/978-3-030-02634-9.
- D. Mishra, V.K. Chaturvedi, Snijesh VP, Noor A. Shaik and M.P. Singh. (2019). Other Databases. Understanding Bioinformatics: Essentials of Bioinformatics Volume I, Understanding Bioinformatics: Genes to Proteins. *Springer Nature Switzerland*, eISBN: 978-3-030-02634-9, pISBN: 978-3-030-02633-2, DOI: 10.1007/978-3-030-02634-9.
- V.K. Chaturvedi, A. Kushwaha, H. Chaurasia, S. Maurya and M.P. Singh (2018). Use of nanomaterials for removal of toxic waste water treatment. *Restoration of Wetland Ecosystem: A Trajectory Towards a Sustainable Environment. Springer Sigapur*, ISBN 978-981-13-7665-8. (In Press)
- V.K. Chaturvedi, S.K. Dubey and M.P. Singh. (2019). Antidiabetic Potential of Medicinal Mushrooms. *Innovations in Plant Science for Better Health: From Soil to Fork. Phytochemicals from Medicinal Plants Scope, Applications, and Potential Health Claims. AAP & CRC Press, New Jersey, USA*, pISBN: 9781771887953. (In Press)
- V.K. Chaturvedi, S.K. Dubey, N. Tabassum and M.P. Singh. (2019). Edible Vaccine: A Journey from Syringe to Mushroom. *Innovations in Plant Science for Better Health: From Soil to Fork. Phytochemicals from Medicinal Plants Scope, Applications, and Potential Health Claims. AAP & CRC Press, New Jersey, USA*, pISBN: 9781771887953. (In Press)
- S. Agarwal, K.K. Gupta, V.K. Chaturvedi, A. Kushwaha, P. Chaurasiya and M.P. Singh. (2018). The Potential Application of Peroxidase Enzyme for the Treatment of Industry Wastes. *Research Advancement in pharmaceutical, Nutritional and Industrial Enzymology. IGI Global, US*, ISBN: 9781522552376, DOI:10.4018/978-1-5225-5237-6.
- A. Kushwaha, S. Maurya, R. Pathak, S. Agarwal, P.K. Chaurasia, M.P. Singh. (2018). Laccase From White Rot Fungi Having Significant Role in Food, Pharma, and Other Industries. *Research Advancements in Pharmaceutical, Nutritional, and Industrial Enzymology. IGI Global, US*, ISBN: 9781522552376, DOI:10.4018/978-1-5225-5237-6.ch011.

CENTRE OF BIOINFORMATICS

- Dixit, S., Srivastava, M. and Katara, P. (2019). 'Computational assessment of polymorphism with linkage disequilibrium and hotspots of recombination in pathogenic genes of *Fusarium oxysporum* f. sp. *lycopersici*'. *Legume res.* (Online Published: 28-02-2019) doi: [10.18805/LR-461](https://doi.org/10.18805/LR-461)

- Mishra, V.K. Chaturvedi, Snijesh VP, Noor A. Shaik and M.P. Singh. (2019). Other Databases. Understanding Bioinformatics: Essentials of Bioinformatics Volume I, Understanding Bioinformatics: Genes to Proteins. *Springer Nature Switzerland*, eISBN: 978-3-030-02634-9, pISBN: 978-3-030-02633-2, DOI: 10.1007/978-3-030-02634-9.
- V.K. Chaturvedi, D. Mishra, A. Tiwari, Snijesh VP, Noor A. Shaik and M.P. Singh. (2019). Sequence Databases. Understanding Bioinformatics: Essentials of Bioinformatics Volume I, Understanding Bioinformatics: Genes to Proteins. *Springer Nature Switzerland*, eISBN: 978-3-030-02634-9, pISBN: 978-3-030-02633-2, DOI: 10.1007/978-3-030-02634-9.
- Yadav, A. and Katara, P. (2018) In-silico mining of SNP-effects on structural properties of CYP2C9 and their consequences'. *International conference on bioinformatics and system biology*, held at IIIT-A, 26-28, October, 2018.
- Singh, R. and Som, A. (2018) Profiling of Ovarian Cancer Reveals Common Features Shared by Other Sub-type of Ovarian Cancer: A network biology approach towards finding therapeutic drug targets. *International conference on bioinformatics and system biology*, held at IIIT-A, 26-28, October, 2018.
- Kumari, P. and Som, A. (2018) Genome wide computational identification of regulatory RNAs in rice plant pathogen *Xanthomonas oryzae*. *International conference on bioinformatics and system biology*, held at IIIT-A, 26-28, October, 2018.

CENTRE FOR WOMEN'S STUDIES

- Anshu, (2018). Social Reforms Movement And Women's Education In The 19th Century (edited by Pradeep Kumar Kesarvani). pp 342-349. Sanrachna Prakashan. Prayagraj, ISBN: 978-93-84999-87-2.

CENTRE FOR DEVELOPMENT STUDIES

- Singh, Virendra P. (2018). Transformation and Restructuring of Professions in Globalizing India, *ETDR*, Vol.25, no. 1&2, pp. 1-12.
- Singh, Virendra P. and M. Sisodia (2018). Social Background of Police Professionals in a Developing Country, *ETDR*, pp. 48-52.
- Shukla, Subhash. (2018). 'India as a Global Power: Emerging or Aspiring', *Indian Journal of Political Science*, Volume LXXIX, No.4, Special Issue, October -December, pp.884-890.
- Shukla, Subhash. (2018). 'Minorities and Indian Constitution', *Dynamics of Public Administration*, Vol.35, No.2, July-December, pp.227-235.
- Srivastava, Sumit Saurabh. (2018). 'Obituary: Saba Mahmood (13 February 1961 - 10 March 2018)', *Indian Anthropologist*, 48(1): 99-101.
- Sharma, Pradeep K. (2019). Dalit literature and history: a socio-historical analysis. In: *Dalit literature and historiography: questioning the cast hegemony in India* (edited by Vikram Harijan and Alok Prasad). pp. 119-152. Delhi: Meena Book Publications (Reprint).
- Srivastava, Sumit Saurabh. (2018). Mapping the intersectionality: caste, gender and violence in India. In: *Problem of caste in India: Investigating history and historiography* (edited by Vikram Harijan). pp. 405-412. Delhi: Meena Book Publications.
- Srivastava, Sumit Saurabh. (2018). Achieving gender equality and women empowerment in India: with special reference to Millennium Development Goal. In: *State and Public Policy* (edited by Kamlesh Gupta). pp. 245-259. New Delhi: Pentagon Press.
- Srivastava, Sumit Saurabh. (2018). Promises and challenges of Dalit entrepreneurship towards inclusive development. In: *Social Inclusion and Development* (edited by Richard Pais and M.H. Makwana). pp. 124-164. Jaipur: Rawat Publications (Reprint).

K. BANERJEE CENTRE OF ATMOSPHERIC AND OCEAN STUDIES

- A. K. Mishra and S. Dwivedi, Assessment of Convective Parametrization Schemes Over the Indian Subcontinent Using a Regional Climate Model, *Theoretical and Applied Climatology*, doi: 10.1007/s00704-018-2679-y (2018).
- A. Kumar, S. Dwivedi, D. Ram Rajak, and A. C. Pandey, Impact of Air-Sea Forcings on the Southern Ocean Sea Ice Variability around the Indian Antarctic Stations, *Polar Science*, 18, 197-212, doi: 10.1016/j.polar.2018.05.005 (2018).

- A. Kumar, S. Dwivedi, and A. C. Pandey, Quantifying predictability of sea ice around the Indian Antarctic stations using coupled ocean sea ice model with shelf ice, *Polar Science*, 18, 83-93, doi:10.1016/j.polar.2018.04.003 (2018).
- A. Srivastava, S. Dwivedi, and A. K. Mishra, Investigating the Role of Air-Sea Forcing on the Variability of Hydrography, Circulation, and Mixed Layer Depth in the Arabian Sea and Bay of Bengal, *Oceanologia*, 60(2), 169-186 (2018).
- S. Dwivedi, A. Srivastava, and A. K. Mishra, Upper Ocean Four-Dimensional Variational Data Assimilation in the Arabian Sea and Bay of Bengal, *Marine Geodesy*, 41(3), 230-257, doi: 10.1080/01490419.2017.1405128 (2018).
- S. Dwivedi, A.K. Mishra, and A. Srivastava, Upper Ocean High Resolution Regional Modeling of the Arabian Sea and Bay of Bengal, *Acta Oceanologica Sinica, In Press* (2018).
- Dirmeyer, P. A., S. Halder and R. J. Bombardi On the harvest of predictability from land surface states in a global forecast model. *J. Geophys. Res.-Atmos.*, 123, 23, 1311-13127, doi: 10.1029/2018JD029103. (2018)
- Niroula, S., S. Halder and S. Ghosh, Perturbations in initial soil moisture conditions: Impacts on hydrologic simulation in a large river basin. *J. Hydrol.*, 561, 509-522, doi: 10.1016/j.jhydrol.2018.04.029. (2018)
- Varga OG, Pontious Jr RG, Singh SK, Szabo S, Intensity Analysis and the Figure of Merit's components for assessment of a Cellular Automata – Markov simulation model. *Ecological Indicators*. 101: 933-942. <https://doi.org/10.1016/j.ecolind.2019.01.057>. (2019)
- Singh KS, Singh SK, Bala A, Szabo S. Estimation of crop evapotranspiration through spatial distributed crop coefficient in a semi-arid environment. *Agriculture Water Management*. 213: 922-933. <https://doi.org/10.1016/j.agwat.2018.12.002> (2019).
- Szabó S, Elemér L, Kovács Z, Püspöki Z, Kertész A, Singh SK, Balázs B. NDVI dynamics as reflected in climatic variables: spatial and temporal trends – A case study of Hungary. *GIScience & Remote Sensing*. DOI:10.1080/15481603.2018.1560686. (2019).
- N Kumar, SK, Singh, HK Pandey. Drainage morphometric analysis using open access earth observation datasets in a drought-affected part of Bundelkhand, India. *Applied Geomatics*. <https://doi.org/10.1007/s12518-018-0218-2> (2018)
- Kumar M, Denis DM, SK Singh, Szabó S, Suryavanshi, S. 2018. Landscape metrics for assessment of land cover change and fragmentation of a heterogeneous watershed. *Remote Sensing Applications: Society and Environment*. <https://doi.org/10.1016/j.rsase.2018.04.002>. (2018)
- Shahi, N K, S Rai and N. Mishra Recent Predictors of Indian summer monsoon based on Indian and Pacific Ocean SST. *Atmos. Phys.* DOI: 10.1007/s00703-018-0585-6. (2018)
- Rawat KS, Singh SK, Bala A. (2018). Estimation of Evapotranspiration through Open Access Earth Observation Data Sets and Its Validation with Ground Observation Edited book Geospatial Applications for Natural Resources Management edited by Singh CK. Chapter 11. 172-189. CRC Press. Boca Raton, FL 33487-2742
- Kumar P, Prasad R, Choudhary A, Singh SK. (2018). Performance Analysis of Different Predictive Algorithms for the Land Features Modeling. Edited book Geospatial Applications for Natural Resources Management edited by Singh CK. Chapter 6. 87-107. CRC Press. Boca Raton, FL 33487-2742.

CENTRE OF MATERIAL SCIENCES

- Singh D., Singh U. B., Pandey M. B., Dhar R. (2019) Dielectric and electro-optic behaviour of nematic-SWCNT nanocomposites under applied bias field. *Liquid Crystals*, 1-7 (online issue) DOI:10.1080/02678292.2019.1573329
- Kumar S., Verma R., Dhar R., Tripathi A. (2019) Li⁺ ion beam irradiation induced changes in the thermodynamic and electrical parameters of 4-n-(nonyloxy) benzoic acid. *Journal of Liquid Crystals* 46(3), 356-366
- Singh B., Tandon A., Pandey A. K. and Singh P. (2018) Enhanced dielectric constant and structural transformation in Fe-doped hydroxyapatite synthesized by wet chemical method. *Journal of Materials Science* 53, 8807 – 8816
- Singh B., Tandon A., Singh P. and Pandey A. K. (2018) Electronic and magnetic field dependent dielectric properties of Zn_{0.95}Fe_{0.05}O. *Journal of Electronic Materials*, 47, 7224 -7231
- Tripathi P., Mishra M., Kumar S., Dabrowski R., Dhar R. (2018) Dependence of physical parameters on the size of silver nanoparticles forming composites with a nematic liquid crystalline material. *Journal of Molecular Liquids* 268, 403-409

- Elkhilgi H.H.M., Khandka S., Yadav N., Dhar R., Dabrowski R. (2018) Effect of manganese (II) titanium oxide nanoparticles on the physical properties of a room temperature nematic liquid crystal 4-(trans-4'-n-hexylcyclohexyl) isothiocyanatobenzene. *Journal of Molecular Liquids* 268, 223-228
- Singh D., Singh U. B., Pandey M. B., Dabrowski R., Dhar R. (2018) Enhancement in electro-optical parameters of nematic liquid crystalline material with SWCNTs. *Journal of Optical Material* 84, 16-21
- Elkhilgi H.H.M., Khandka S., Singh U. B., Dabrowski R., Dhar R. (2018) Dielectric and electro-optical properties of a nematic liquid crystalline material with gold nanoparticles. *Journal of Liquid Crystals* 45(12), 1795-1801
- Singh A. K., Iqbal A., Singh U. B., Dabrowski R. S., Dhar R. (2018) Thermodynamic, optical and switching parameters of a ferroelectric liquid crystalline material having SmA*-SmC*-SmB_h* phase sequence. *Journal of Phase Transitions* 91(8), 811-820
- Dwivedi A., Verma R., Dhar R., Dabrowski R. (2018) Exploration of dielectric relaxations of a room temperature anti-ferroelectric liquid crystal mixture (AIP Conference)
- Kumar S., Verma R., Dwivedi A., Dhar R., Tripathi A. (2018) Improving the thermal stability and electrical parameters of a liquid crystalline material 4-n(nonyloxy)benzoic acid by using Li ion beam irradiation (AIP Conference)
- Singh D., Singh U. B., Pandey M. B., Dabrowski R., Dhar R. (2018) Improvement of orientational order and display parameters of liquid crystalline material dispersed with single -wall carbon nanotubes. *Journal of Materials Letters* 216, 5-7
- Mishra A., Dabrowski R., Dhar R. (2018) Dielectric characteristics of highly ionic anti-ferroelectric liquid crystalline material. *Journal of Molecular Liquids* 249, 106-109
- Seth, J., Dubey, P., Chaudhari, V.R. and Prasad, B.L.V. (2018). Preparation of metal oxide supported catalysts and their utilization for understanding the effect of a support on the catalytic activity. *New Journal of Chemistry*, 42, 402-410.
- Bhati, A., Anand, S.R., Saini, D., Khare, P., Dubey, P. and Sonkar, S.K. (2018). Self-doped nontoxic red-emitting Mg-N-embedded carbon dots for imaging, Cu(II) sensing and fluorescent ink. *New Journal of Chemistry*, 42, 19548-19556.
- Yadav Neelam and Dhar Ravindra (2019). *Liquid Crystalline Materials for Efficient Solar Energy Harvesting in Nonconventional Liquid Crystals and Their Applications* (Eds: Wei Lee and Sandeep Kumar), Beijing, Walter De Gruyter GmbH.
- Bajpai M., Pandey C. K., Srivastava R., Malik R., Shukla G. P., Dhar R. (2018) Surface plasmon enhanced organic solar cells using thermally deposited Au nanoparticles. *AIP Conference Proceedings* 2050 (1), 020023.
- Pandey C. K., Bajpai M., Srivastava R., Malik R., Shukla G. P., Katiyar A. K., Dhar R. (2018) Effect of n-type doping on the electron transport of polyfluorene, *AIP Conference Proceedings* 2050 (1), 020024.

NANO TECHNOLOGY APPLICATION CENTER

- Substrate effect on the evolution of surface morphology of BaF₂ thin films: A study based on fractal concepts, RK Pandey, RP Yadav, Manvendra Kumar, HP Bhasker, AK Mittal, AC Pandey, SN Pandey *Applied Surface Science*, 466, 780-786 (2019)
- Tolnaftate-graphene composite-loaded nanoengineered electrospun scaffolds as efficient therapeutic dressing material for regimen of dermatomycosis, Shashi Kiran Misra, Pramod W Ramteke, Sandip Patil, Avinash C Pandey, Himanshu Pandey, *Applied Nanoscience*, 8(7), 1629-1640 (2018)
- Surface modification of aligned TiO₂ nanotubes by Cu₂O nanoparticles and their enhanced photo electrochemical properties and hydrogen generation application, Pawan Kumar Dubey, Rajesh Kumar, Radhey Shyam Tiwari, Onkar Nath Srivastava, Avinash Chandra Pandey, Prabhakar Singh, *International Journal of Hydrogen Energy*, 43(14), 6867-6878 (2018)

CENTRE OF SCIENCE AND SOCIETY

(Rural Technology and Development)

- Singh, J., Vishwakarma, K., Mishra, R.K. *et. al.*, (2019). *Nanomaterials and Microbes, Interaction: A contemporary overview*. 3Biotech, (Springer), 9(3):68. doi: 10.1007/s13205-019-1576-0, Impact Factor: 1.8.
- Kar, S., Mishra, R.K., Pathak, A., Dikshit, A. and Rao, G.A. (2018). *In silico* modeling and synthesis of phenyl and thienyl analogs of chalcones for potential leads as anti-bacterial agents. *Journal of Molecular Structure* 1156: 433-

440 (Elsevier), DOI: 10.1016/j.molstruc.2017.12.002 *Impact Factor: 1.75*, ISSN: 0022-2860, UGC J. ID. No. 24702.

- Singh, R., Singh, P., Jha, S., Pathak, A., Shukla, S.K., Dikshit, A. and Mishra, R.K. (2018). Synergistic effect of essential oils of three Gymnosperms against *Vibrio cholerae*. *International Journal for Research in Applied Science & Engineering Technology (IJRASET)*, 6:(III) ISSN: 2321-9653.
- Singh, R., Pathak, A., Dikshit, A. and Mishra, R.K. (2018). Antibacterial evaluation of essential oils of *Juniperus communis*, *Pinus roxburghii* and *Thuja occidentalis* against *Escherichia coli*. *Biochem. Cell. Arch.*, 18(1): 241-244, ISSN 0972-5075.
- Singh, R., Pathak, A., Dikshit, A. and Mishra, R.K. (2018). Comparison of Biological Activities of essential oil of three Gymnosperms against *Salmonella typhimurium*. *International Journal of Creative Research Thoughts (IJCRT)*, 6(1): 1420-1426, ISSN: 2320-2882.
- Singh, R., Pathak, A., Tripathi, S.K., Dikshit, A. and Mishra, R.K. (2018). A Reassessment on Essential Oils. *International Journal for Research Trends and Innovation*, 3(6): 177-187, ISSN: 2456-3315.
- Singh, R., Jha, S., Pandey, A., Dikshit, A. and Mishra, R.K. (2018). Comparison of antibacterial activities of essential oils of *Juniperus communis* L., *Pinus roxburghii* Sarg. and *Taxodium distichum* L. against *Klebsiella pneumoniae*. *Journal of Emerging Technologies and Innovative Research (JETIR)* 5(8): 661-669, ISSN-2349-5162.

CENTRE OF BEHAVIORAL AND COGNITIVE SCIENCES

- Singh, A., & Srinivasan, N. (2019). Concentrative (Sahaj Samadhi) meditation training expands subjective time. *PsyCh Journal*, 8, 28-35.
- Indrajeet, I., & Ray, S. (2019). Detectability of stop-signal determines magnitude of deceleration in saccade planning. *European Journal of Neuroscience*, 49(2), 232- 249.
- Singh, J. P. & Kar, B. R. (2018). Effect of language proficiency on proactive occulo-motor control among bilinguals. *PLoS one*, 13(12), e0207904
- Kar, B. R., Srinivasan, N., Nehabala, Y., & Nigam, R. (2018). Proactive and reactive control depends on emotional valence: A Stroop study with emotional expressions and words. *Cognition & Emotion*, 32, 325-340.
- Mukherjee, S., Srinivasan, N., Manjaly, J. A., & Kumar, N. (2018). Perceptual broadening leads to more prosociality. *Frontiers in Psychology*, 9:1821.
- Mishra, M., Baloni, S., & Srinivasan, N. (2018). Cross-cultural emotion recognition and evaluation of Radboud faces database with an Indian Sample. *Plos One*, 13(10): e0203959.
- vonMühlénen, A., Bellaera, L., Singh, A., & Srinivasan, N. (2018). The effect of sadness on global-local processing. *Attention, Perception & Psychophysics*, 80, 1072-1082.
- Battu, B., Pammi, V. S. C., & Srinivasan, N. (2018). Evolution of cooperation with heterogeneous conditional cooperators. *Scientific Reports*, 8:4524.
- Kar, B. R., Nigam, R., Pammi, V.S.C., Guleria, A. (In press). Neurocognitive mechanisms of affective conflict adaptation: An event related fMRI. *Emotion and cognition*, *Progress in Brain Research*, 246.
- Singh, A., Pammi, V.S.C., Guleria, A., & Srinivasan, N. (2019). Concentrative (Sahaj Samadhi) meditation training and visual awareness: A fMRI study on color afterimages. *Progress in Brain Research*, 244, 185-206.
- SRINIVASAN, N. (2019). *MEDITATION.PROGRESS IN BRAIN RESEARCH*, AMSTERDAM, ELSEVIER

CENTRE OF FOOD TECHNOLOGY

- Singh P, Saini P, Srivastava U and Singh A. 2019. Microbial Polysaccharides as an Alternative Biodegradable Packaging Material. *In Research Trends in Food Technology and Nutrition*, Vol. 7, AkiNik Publications, Delhi. p 37-62.
- Srivastava U, Saini P, Singh P and Singh A. 2019. Cold Plasma: Functionality and Recent Prospects towards Health and Hygiene. *In Research Trends in Food Technology and Nutrition*, Vol. 7, AkiNik Publications, Delhi. p 91-119.
- Singh, M., Kaur, D., Kushwaha, R. and Singh, V. (2019). Packaging of Fruits and Vegetables with Edible Coating. pp 75-98. Akinik publication.
- Verma, V., Singh, Z. and Yadav, N. (2019). Maillard reaction and effect of various factors on the formation of maillard products and its impact on processed food products. pp 63-79. Akinik publication.

- Gupta, E., Purwar, S., Maurya, N.K., Shakyawar, S. and Alok, S. (2018). Formulation of value added lowcalorie, high fibre biscuits using flax seeds and *stevia rebaudiana*. International Journal of Pharmaceutical Sciences and Research, 14 (12), 1-12.
- Verma, V., Chauhan, O.P. and Nanjappa, C. (2018). Optimization process for the development of soymilk-based strawberry RTS beverages. Plant Archives, 18, 600-607
- Srivastava, R., Mishra, N., Agarwal, S. and Mishra, N. (2018). Pharmacological and phytochemical properties of kaitha (*Feronia limonia* L.) : A review. Plant Archives, 18, 608-615
- Mishra, P., Shukla, P.K. and Mishra, R.R. (2018). Phytochemicals as Protagonist for the Treatment and Management of Autoimmune Diseases. pp 427-439. Apple Academic Press.
- Yadav, N., Kaur, D., Malviya, R., Singh, M., Fatima, M. and Singh, L. (2018). Effect of thermal and non-thermal processing on antioxidant potential of cowpea seeds. International Journal of Food Properties, 27 (4), 437-451.
- Qamar, A.F., Rizvi, F., Kumar, D., Puranik, V., Kumar, N. and Chauhan, D.K. (2018). Amelioration of therapeutic potential of Moringa oleifera leaves through value added products development. International Journal of Green and Herbal Chemistry, 7 (3), 529-540.
- Shukla, S., Puranik, V., Kaur, D., Agrawal, P. and Mishra, V. (2018). Effect of dehydration on the phytochemical properties of herbs for the development of nutraceutical rich herbal squash. International Journal of Green and Herbal Chemistry, 7 (3), 551-570.
- Kushwaha, R., Singh, V., Singh, M., Rana, A. and Kaur, D. (2018). Influence of osmotic agents on drying behavior and Product quality of guava fruit. Plant Archives, 18, 205-209.
- Kushwaha, R., Singh, V., Kaur, D. and Prakash, M. (2018). Optimization of sweetener blends for the preparation of Indian ethnic snack. International Journal of Life Sciences Research, 6 (3), 455-463.
- Singh, P., Singh, A. and Saini, P. (2018). Effect of High Pressure processing on quality of fruits and vegetable products. In: Trends & Prospects in Processing of Horticultural Crops, Today and Tomorrow's. pp 209-222. Printers and Publishers, New Delhi.
- Srivastava, U. and Saini, P. (2018). Biosynthesis of Folate by Probiotic Bacteria: Current Knowledge and Future Potential In:Trend and Prospects in food Technology ,Processing and Presevation. (edited by Payel Panja). pp 667-683. Today and Tomorrow's Printers and Publishers.
- Tiwari, N., Kaur, D. and Mishra, P. (2018). Impact of Particle size reduction and hydrothermal treatments on the dietary fibre and antioxidants properties of wheat bran. Journal of Emerging Technologies and Innovative Research, 360-373.
- Singh, V., Kumar, S. and Rai, A.K. (2018). Sensory analysis of bar samples prepared from mahua (*Madhuca longifolia*) flower syrup using fuzzy logic. pp 137-144. Nutrafoods.
- Sharma, U. and Yadav, N. (2018). Prevalence and risk factors of anemia and zinc deficiency among 4-6 year old children of Allahabad district, Uttar Pradesh. Indian Journal of Public Health, 79-82.
- Kumar, R., Yadav, N., Yadav, R. and Vaishali (2019) Traditional - Biotechnologically processed foods VS nutritional security and sustainable agricultural practices , *Prog. Agric* 19(1): 146-152.

CENTRE OF COMPUTER EDUCATION

- Srikanth V., Chaturvedi Ashish. "Consumer Trends and Online Shopping: An effective application of data mining" published in Journal of Advances and scholarly Researches in allied education, Volume:15, Issue 1, April 2018 ISSN:2230-7540,PP:68-71 (Impact Factor FACTOR:1.6).
- Srikanth V., Chaturvedi Ashish. "Analysis on data mining techniques in Online Shopping" published in Journal of Advances and scholarly Researches in allied education, Volume : 15, Issue 3, May 2018 ISSN:2230-7540,PP:45-48. (Impact FACTOR 1.6).
- Rai, Rajat Kumar; Singh, Sandeep; Srivastava, Akhil; Rai, Abhay Kumar, Tewari, Rajiv Ranjan. "Finding Maximum Clique in Graphs using Branch and Bound Technique" in International Conference on "Advances in Computing, Control & Communication Technology (IAC3T-2018)", CCE, IPS, University of Allahabad, Allahabad (Published in IEEE Explore, Publication No. 8672397).
- Yadav Sarika and Yadav Rama Shankar. "Redundancy Elimination during Data Aggregation in Wireless Sensor Networks for IoT Systems", published in Recent Trends in Communication, Computing, and Electronics. Lecture Notes in Electrical Engineering, Vol. [524.pp.no.](#) 195-205 Springer, Singapore. (doi.org/10.1007/978-981-13-2685-1_20).

- Farha and Yadav, Ram Suchit. "Frequency reconfigurable antenna with air substrate for S-band", published by IEEE in 2018 International Conference on Computational and Characterization Techniques in Engineering & Sciences (CCTES) held at Lucknow (<https://ieeexplore.ieee.org/document/8673976>).

CENTRE OF MEDIA STUDIES

- चोपड़ा धनंजय ; अपराध पत्रकारिता बनाम बदलते सरोकार; मीडिया विमर्श ; वर्ष 12 अंक 47 अप्रैल-जून 2018 ; पृ0 34-35 ; ISSN : 2249-0590; अप्रैल-जून, 2018 ।
- चोपड़ा धनंजय ; संगम की रेती पर जिंदगी के फलसफे सिखाता है कुंभ; हिन्दी जगत (विश्व हिन्दी न्यास की शोध पत्रिका); वर्ष: 19, अंक : 3 ; पृ0 16-17; ISSN : 1543-8651 (USA); जुलाई-सितम्बर, 2018 ।
- चोपड़ा धनंजय ; विजुअल एक्सप्लोजन और फोटोग्राफी की बदलती दुनिया ; आंचलिक पत्रकार (माधवराव सप्रे स्मृति समाचार पत्र संग्रहालय एवं शोध संस्थान, भोपाल की शोध पत्रिका) ; वर्ष 38, अंक-2, पूर्णांक-438; ISSN : 2319-3107 ; 15 अक्टूबर, 2018 ।
- चोपड़ा धनंजय ; बेखबर मतदाता को खबरदार होने की जरूरत ; आंचलिक पत्रकार (माधवराव सप्रे स्मृति समाचार पत्र संग्रहालय एवं शोध संस्थान, भोपाल की शोध पत्रिका) ; वर्ष 38, अंक-3, पूर्णांक-439ए ISSN : 2319-3107 ; 15 नवम्बर 2018 ।
- चोपड़ा धनंजय ; स्कूली पाठ्यक्रमों में बदलाव की आवश्यकता : बच्चों का कल्पनालोक और व्यवहारिक अनुभव हों शामिल ; अधिगम (राज्य शिक्षा संस्थान, उत्तर प्रदेश की शोध पत्रिका) ; अंक-9 ISSN : 2394-7737 ; नवम्बर 2018 ।
- चोपड़ा धनंजय ; चुनाव में अखबारों की साख लगती है दांव पर; मीडिया विमर्श; वर्ष 13, अंक-49; पृ0 22-3; ISSN : 2249-0590; दिसम्बर 2018 ।
- चोपड़ा धनंजय ; कुंभ, कैमरा और जन इतिहास रचते लोग ; विज्ञान (विज्ञान परिषद, प्रयाग की शोध पत्रिका) वर्ष 104, अंक-12 ; पृ0 2-3 ; ISSN : 373-1200 ; मार्च 2019 ।
- चोपड़ा धनंजय (2018); फिल्म समीक्षाओं का बदलता परिदृश्य; भारतीय सिनेमा की विकास मात्रा (संपादक : मधुरानी शुक्ला) ; प्रकाशक : कनिष्क पब्लिशिंग हाउस, नई दिल्ली; ISBN : 978.93.86556.06.6
- चोपड़ा धनंजय (2018); नित नया होता मीडिया और हमारी भाषा हिन्दी ; विश्व हिन्दी सम्मेलन स्मारिका ; प्रकाशक : विदेश मंत्रालय, भारत सरकार, नई दिल्ली ।
- चोपड़ा धनंजय (2019); जीने की राह सिखाती है प्रयाग की पत्रकारिता ; प्रयाग अंक, उत्तर प्रदेश ; प्रकाशक : सूचना एवं जनसम्पर्क विभाग, उत्तर प्रदेश सरकार ।
- Tripathi Shashank (2018); Making of Kumbh; Publisher Spenta Multimedia Private Limited, Mumbai (Funded by UP Government).
- Tripathi Shashank (2019); Prayagraj Tourism; Bennett Coleman & Co. Ltd., New Delhi (Funded by UP Government).

CENTRE OF FASHION DESIGN & TECHNOLOGY

- Singh, S. and Rai A., (2018). Change By Design: How Design Thinking Transforms Organizations and Inspires Innovation full, Tim Brown, Harper Business, 209, 264 pp (without index): A Review. International Journal of Research and Analytical Reviews, ISSN: 2349-5138, Vol. 5, 1904x-1905x.
- Purwar Shristi & Devodiya (2018): Scenario of Women Education, Employment and Entrepreneurship, (edited by: Shrama A.) ISBN: 978-81-7611-771-5, RBSA Publishers, Jaipur, page no. 59 -69
- Srivastava Niharika & Purwar Shristi (2018): Prospects and Challenges of Women Boutique Enterprises: with special reference to Allahabad Division, (edited by: Bhakar S. S., Gulati C. & Kaurav RPS.) ISBN no. 978-93-86608-56-7, Bharti Publication, New Delhi, page no. 583-595
- Purwar Shristi (2019): Digital Marketing: An Effective Tool of Fashion Marketing, ISBN No. 978-93-5311-464-0, (edited by: Bhakar S. S., Gupta M. & Kaurav RPS.), SSRN Publication, page no. 583-595
- Singh S., (2018). Study of Hand Painted Kalamkari to Design New Motifs, International Journal of Computer Application, ISSN: 2250-1797, Vol 2, 25-40.
- Purwar Shristi (2018): Entrepreneurial Transformation in Chikankari Embroidery Handicraft, International Journal of Applied Home Science, ISSN: 2394 - 1413, Vol-5, Issue-1, page no. 180 – 184
- Purwar Shristi (2018): Folk art: An effective Tool of Designing, International Journal of Applied Home Science, ISSN: 2394 - 1413, Vol-5, Issue-2, page no. 154
- Purwar Shristi & Narayan Jagdish (2018): Inclusive Growth & Development in India –PMJDY in the context of Allahabad City, Journal of Business Economics, Vol. XI, Issue II, ISSN 2320 -110X Page no. 16- 24
- Jaiswal.A (March 2018) Innovation in old coin as jewelry fashioned with enameling and semi precious stones , International journal of applied home science, ISSN:2394-1413, Vol.5, Issue 2.

- Jaiswal.A (April 2018), Folk songs and drama-an important tool of communication, International journal of applied home science, ISSN:2394-1413,Vol.5, Issue 4
- Jaiswal.A (March 2019), Diversification of old coins-as cultural sustainability and social development, Environmental & Health Sustainability, ISBN 978-93-81022-06-1,Lucknow
- Jaiswal.A (Dec 2018), Digital Branding-As Building of Consumer's Experiences, SSRN Library, ISBN 978-93-5311-464-0,E-Library.

NATIONAL CENTRE OF EXPERIMENTAL MINERALOGY AND PETROLOGY

- Upadhyay R. and Pandey K. (2018) Importance of membrane filtration in water purification. *Bharatiya vaigyanik evam Audyogik Anusandhan Patrika*, CSIR-NISCAIR, 2,69-93
- Niyogi, A., Pati, J.K., Pati, S.K., Panda, D. and Chakarvorty, M. (2018) Magnetic measurements and geochemical characterization of the road-deposited sediments (RDS), Allahabad city, India: impact of climatic perturbations on sediment composition and provenance tracing. *Journal of Soils and Sediments (Springer)*, 18(7), 2581-2595. DOI:10.1007/s11368-018-1936-0).
- Niyogi, A., Pati, J.K., Panigrahi, M.K., Panda, D., Chakarvorty, M. and Parthasarathy, G. (2018) Raman, infrared and chemical characterization of fly ash-generated spherules. *Journal of Applied Spectroscopy (Springer)*, v. 85, No.5, 752-759.
- Pati, J.K., Reimold, W.U. and Hauser, N. (2018) Comment on "Anatomy of impactites and shocked zircon grains from Dhala reveals Paleoproterozoic meteorite impact in the Archean basement rocks of Central India" by Li et al., 2018. *Gondwana Research (Elsevier)*, 60, 214-217. DOI: 10.1016/j.gr.2018.03.019.
- Rai, A.K., Pati, J.K. and Kumar, R. (2019) Spectro-chemical study of moldavites from Ries impact structure (Germany) using LIBS. *Optics and Laser Technology (Elsevier)*, 114, 146-157.
- Alfimova, N., Mohd Baqar Raza, Felitsyn, S., Matrenichev, V., Bogomolov, E., Nasipuri, P., Saha, L., Pati, J.K., Kumar, V. (2019) Isotopic Sm-Nd signatures of Precambrian Banded Iron Formation from the Fennoscandian shield, East-European Platform and Bundelkhand craton, India. *Precambrian Research (Elsevier)*, <https://doi.org/10.1016/j.precamres.2019.04.008>.
- Mohamed A.E., El-Sayyad S.G., Mohamed E. A., Pal K., Asthana N., Junior de souza G .F., Mosallam M. F., Gobara M., and El-Batal I.A.,(2019). Layer-by-layer preparation and characterization of recyclable nanocomposite (CoxNi1xFe2O4; X=0.9/SiO2/TiO2). *Journal of Materials Science: Materials in Electronics*, 30, 1-17.
- Nasipuri, P., Saha, L., Xie, H., Pati, J.K., Satyanarayanan, M., Sarkar, S., Bhandari, A. and Gaur, Y. (2019) Paleoproterozoic crustal evolution of the Bundelkhand craton, north-central India. In: van Kranendonk, M., Bennett, V. and Hoffmann, J.E. (Eds.) *Earth's Oldest Rock (2nd Edition)*, Elsevier, Amsterdam, 792-817.
- Asthana N., Dwivedi M.M., and Pandey K. (2019) Spectroscopic and Ionic Study of PVdF – Flyash Composite Electrolyte at Different P-T Condition. *National Conference on Exotic Materials And Devices*, PP-38. Department Of Physics (MMV), Banaras Hindu University, Varanasi
- Asthana N., Dwivedi M.M., and Pandey K., (2018) Ionic study of Graphite oxide dispersed polymer Electrolyte and their Device Application. *Proc National Conference on Soft Materials*. PP-21. DDU Gorakhpur University, Gorakhpur.
- Pandey K., Dwivedi M.M., and., Asthana N.,(2018) Development and Application of polymer nanocomposite membranes for water filtration. *Proc National Conference on Soft Materials*. PP-21 DDU Gorakhpur University, Gorakhpur.
- Pandey K., (2019) Development of some new polymer membrane for the production of safe drinking water. *National seminar on recent advance in materials science and electronic*. Department of Physics and electronics, PP-26 Dr. Ram Manohar Lohia Awadh University Ayodhya
- Pandey K., Dwivedi M.M., and., Asthana N.,(2018) Ion transport study of Polymer Nano Composite Electrolyte for Electrochemical device Application. NSAMS. PP-44 Department of Physics DDU Gorakhpur University Gorakhpur
- Pandey K., Dwivedi M.M., Asthana N., Roy D., Yadav A. K.,(2018) *Structural study of PVA membrane with multi farious solvents by spectroscopic technique*. PP-070 DAE-NLS -27. RRCAT Indore
- Asthana N., Dwivedi M.M., and Pandey K.(2018) Spectroscopic and Ionic Study on Plasticized PCL- Lithium triflate System. PP-140 DAE-NLS -27. RRCAT Indore

GOVIND BALLABH PANT SOCIAL SCIENCE INSTITUTE

- Badri Narayan Tiwari, 2018: (Paper back edition) Kanchiram: Leader of the Dalits, Penguin Books, ISBN 9780143446651
- Kalpagam, U. (2019) Neoliberalism and Women in India: Governmentality Perspectives Lanham, MD, USA: Lexington Books.
- Bhaskar Majumder 'Child Rag Pickers in the City of Allahabad, Uttar Pradesh: Some Facts' (jointly with G. Rajvanshi), Man & Development, Vol. XL No. 3, September, 2018.
- Bhaskar Majumder 'Disguised Employment: A Case Study of Women Beedi Rolling Workers in the District of Allahabad, Uttar Pradesh' (jointly with J. Patel), Manpower Journal, Vol. LII, No. 3, July-Sept. 2018.
- Bhaskar Majumder 'Child Waste Pickers in the City of Allahabad, Uttar Pradesh: Unfolding Some Facts'' (jointly with G. Rajvanshi), Productivity, Vol. 59, No. 1, July-September, 2019.
- Bhaskar Majumder, 'Dual-Step Migration from a Village in Uttar Pradesh: Causes, Processes, and Consequences' (jointly with Md. Taukeer), April-June, Productivity, 2019.
- Bhaskar Majumder "Living Conditions of Households in Slums in Allahabad City, Uttar Pradesh: Some Implications", (jointly with Sima Yadav), Man & Development, June, 2019.
- Prof. A.R. Mishra: "राज्य और धर्म : सूफी विचारधारा और मुक्ति का सवाल", प्रतिमान: जनवरी-जून, 2018, वर्ष 6, अंक 11, ISSN: 2320-8201
- Gopani, C. (2018) Dalita Madyatharagati -Dalit Udyamam (Dalit Middle Class-Dalit Movement). Nadustuna Telangana. April. Pp 39-42. ISSN 2349-2376
- Gopani, C. (2018) Dalita Udyama Velugu Needalu (Dalit Movement's light and shade). Nadustuna Telangana. August. Pp. 34-38. ISSN 2349-2376
- Gopani, C. (2018) Kula Vevastalo Peedita Kulalau: Vairudyalu Ikyata (Oppressed Castes in Caste system; Contradictions and Unity). Nadustuna Telangana. September. Pp.39-43. ISSN 2349-2376
- Goapni, C. (2018) Kulanthara Vivahalu -Kula Nirmulana Drukpadam, (Inter Caste Marriages-Annihilation of Caste Perspective). Nadustuna Telangana. October. Pp.12-16. ISSN 2349-2376
- Bhaskar Majumder, 'Home-Based Women Beedi Rolling Workers in Uttar Pradesh: Livelihood Conditions and Options' (jointly with J. Patel), in 'Development and Exclusion in India (Ed. Majumder, R. et al), Segment Books, 2019.
- Bhaskar Majumder, 'Dispossession for Development: Some Recent Experiences in Uttar Pradesh, India', in Mishra S. & Shiva Prasad (Ed.), Displacement, Impoverishment and Exclusion - Political Economy of Development in India, Aakar Books, 2018.
- Bhaskar Majumder , 'Migration of Rural Labourers to Brick Kilns in Uttar Pradesh under Conditions of Rent-Seeking' in Chattopadhyay A. K. et al (Ed), 'Economic Development in India, Issues and Challenges', Manak Publications, New Delhi, 2018.
- Singh, Archana (2019). "Rural Dalit Women: Assertion for change" in A.K. Pankaj & A.K.Pandey (ed.) Dalits, Subalternity and Social Change in India. New Delhi, Routledge Publication, pp.129-135.
- Singh, Archana (2019). "Invisible Lives: Denotified Tribes of Uttar Pradesh" in Joy T.SVD & George K. Angami (ed.) India's Northeast A Celebration of Cultures. New Delhi, ISPCK, Publication, pp. 227-234.
- Keshri, K. (Forthcoming). "Temporary Labou Migration in India: Regional Pattern, Characteristics, and Associated Factors", In R. B. Bhagat, Archana K. Roy and Harihar Sahoo (Eds.) Migration and Development in India: Emerging Issues and Challenges. Routledge: New Delhi.
- Gopani, C. (2018). New Dalit Movements; An Ambedkarite Perspective. In: The Radical in Ambedkar (edited by Yengde, Suraj, Anand Teltumbde). Pp 181-218. Penguin Random House India, Haryana. ISBN 978-0-670-09115-7
- Gopani, C (with V.Swetha). (2019). Contesting Caste and Gender Hierarchy; Understanding Dalit Women Literary Writings in Telugu. In: Dalit literature and Historiography. (edited by Vikram Harijan, Alok Prasad). Pp. 44-56. Meena Book Publications, Delhi. ISBN 978-93-85957-11-6
- Gopani, C (with Pooja Pandey). (2019). Caste Practice in Urban Space; A literature survey. In: Dalit literature and Historiography. (edited by Vikram, Harijan, Alok Prasad). Pp. 107-118. Meena Book Publications, Delhi. ISBN 978-93-85957-11-6

Rajiv Gandhi Chair in Contemporary Studies

- Minu Jha, India and the Civil Nuclear Liability Regime, *Indian Journal of Public Administration*, Sage Publications, April-June, 2019, New Delhi.

RESEARCH PUBLICATIONS OF CONSTITUENT COLLEGES

ALLAHABAD DEGREE COLLEGE

- Bisarya, R S. (2019) Pariyavaran Vidhi, Jaipur :University Book House Pvt. Ltd.
- Srivastava, S. C. (2018). Bhartiya Sakshya Adhinyam, Prayagraj, Central Law Publication
- Tripathi, R. K. (2018). Sanskrit Grantho me Kaushambi, Prayagraj: BalajiPrakashan.
- Tripathi, R. K. (2018) RasrajToshini , Prayagraj: VaijayantPrakashan
- Tripathi, R. K. (2019) PrayagrajKumbhkatha. New Delhi :PrabhatPrakashan.

ARYA KANYA DEGREE COLLEGE

- Dr. Rama Singh, Tulnatmak Rajneeti, 2018, Shiv Bharti Publishing ISBN – 978-93-81907
- Dr. Kalpana Verma, Parampara Aur Aadhunika, Jagat Bharti Prakashan, 2018 ISBN – 9789384480301
- Dr. Kalpana Verma, Hindi Sahitya ka Itihas : Bodhgama Path, Sahitya Sangam, 2018 ISBN – 9788180972850
- Dr. Rama Singh, International Journal of Advance and Imperative Research, Part 4, Social Change in India. January, 2019, Society by Constitution ISSN – 2394-7780
- Dr. Rama Singh, Sodh Drishti, An International Peer Reviewed, April-2018, Social Reform in Indian Constitution ISSN - 0976-6650
- Dr. Rama Singh, Sahitya Sangam Vaichariki, July-2018, Swachata ek Anveshan: Puratan se Adhyatan ISSN - 2277-5315
- Dr. Kalpana Verma, International Journal – Muktibodh aur unki Bhul- Galti, Ajanta Prakashan, March-August 2018 ISSN – 2319359*PP119120
- Dr. Kalpana Verma, National Journal – Shiksha evam Teknik ke kshetra me Hindi ka mahatva, Patliputra, Journal of Indology, August 2018 ISSN – 2320351*PP119120
- ISSN – 2320351*PP119120
- Dr. Chitra Chaurasia, Bhakti Evam Sangeet ki Ananya Upasak Sidheshwari Devi, Research Review Journal No. – 44945, Impact Fact 5.214 ISSN – 24553085, Nov 2018
- Dr. Chitra Chaurasia, Sangit Udgam evam vikas, International Journal of Research and Analytical Reviews, Impact Fact 5.75 ISSN – 23481269, Print ISSN – 23495138, Oct- Dec 2018
- Radha Rani Singh, Samaveshi Shiksha ko Badhit karne wale Karko ka Nivaran me Shikshko ki Bhumika ka Adhyayan, Global Journal for Research Analysis, January 2019 ISSN – 22778160*PP4344, Impact fact 85.78
- Smt. Shikha Jaiswal, Pustkalya me Praudhyogiki ka Prayog, International Journal of Research and Analytical Reviews, Oct- Dec 2018
- Dr. Pushplata Agarwal, Mahila Shashaktikaran Ka Pratik Sanskrit Sahitya ki Mahila Kaviyitriya, Sanskrit Vandhya me Mahilao ka Vashwik Avadan, Aparajita 2018 PP4350
- Dr. Hemlata Srivastava, Naye Bharat Me Mahilao ki Bhumika, Ed Sabiha Rahmani, Sociology Department of Rajkiya Mahila Mahavidyalaya, ISSN – 9788192428970*PP5657, 2018
- Dr. Smita, Rashtra Nirman Me Nari ka Yogdaan, Naye Bharat me Mahilao ki Bhumika, Ed Sabiha Rahmani, Sociology Department of Rajkiya Mahila Mahavidyalaya, ISSN – 9788192428970*PP5657, 2018
- Dr. Nisha Khanna, Sanskrit Vangmey May Nari ke Adhikar, Vishwabharti, Edited By Anita Sen gupta, Ishwar Sharan PG College, University of Allahabad, Prayadraj ISSN – 9788192290058*PP1317, 2018
- Dr. Jyoti Rani Jaiswal, Vedo Me Nari ka Mahatava, Aparajita 2018 ISBN – 978-81-922900-6-5
- Dr. Archana Singh, Akbar Kaleen Samajik Nyay Ki Awadharna, Samajik Nyay, Vikas evam Loktantra “Chunautiyan evam Sambhavnayen” Edited by Amiya Kumar, Sandeep Kumar Singh, Niharika Tiwari pp 323-325 ISBN 9789383762972

C.M.P. DEGREE COLLEGE

- Ahmad, N. (2018) ‘Urdu Afsana Rooman se Haqiqattak’. Book is awarded by Bihar Urdu Academy, Bihar Government.
- Kumar Brijesh and Jagdish Prakash (2018) “ Auditing (Ankekshan)” Unique Publication, Allahabad,

- Kumar Brijesh and Jagdish Prakash (2018). “Adhunik Vyavsayic Sangthan” Unique Publication, Allahabad.
- Pandey, B.D. (2018) ‘ Law of the Press’(As first Author) Kamal Publishers, New Delhi, ISBN : 978-81-929901-3-2
- Pandey, M. and Pandey, S. A (2019) Uttar Pradesh Rajaswa Sanhita (In Hindi), Central Law Publication,
- Pant, Hemlata (2019) “Soil Science”, Published by write and Print Publication, New Delhi, ISBN : 978-93- 88317-06-1.
- Pant, H. and Singh, M. K. (2018) Manushya Me Hone Wale Kush Mahatvapurna Rog Ka UnkaNidan, Published by SBSRD, Allahabad (U.P.), (ISBN: 978-81-923535-4-8) Page No. 1-236.
- Singh, S.S. (2018) “ बालको के विरुद्ध अपराध एवम किशोर अपराध,” Central Law Publication, Allahabad, ISBN -978-93-86456-44-1.
- Singh, N.K.(2018) “Satrahvi Shatabdi ka Bihar: Aarthik evam Samajic Jeevan” Published by K.P.Jayaswal Research Institute, Patna, Govt. of Bihar, ISBN:81-89785-19-2
- Singh S.P. (2018) “पालि-प्राकृत ग्रन्थों का काव्य शास्त्रीय अध्ययन”
- Srivastava, Roli (2019) “Global Warming- Samasya aur Samadhan” Published by Panchjanya Prakashan, New Delhi.
- Gupta Arti, Das Sunanda, Agrawal Babita . (2018) “ Advances in Chemical and Applied Sciences-Vol. 1 ” First Print Publications, Allahabad. ISBN: 978-81-9350520-5.
- Singh V. P. (2018) “Plant Life under changing environment” Elsevier Publication.
- Pant, Hemlata and Singh, M. K. (2018): Manushya Me Hone Wale Kush Mahatvapurna Rog Ka UnkaNidan, Published by SBSRD, Allahabad (U.P.), (ISBN: 978-81-923535-4-8) Page No. 1-236.
- Pant, Hemlata; Srivastava, D.K.;Singh P.;Swaroop, D. and Singh, K. (2018): New Approaches in Agricultural, Environmental & Nutrition Technology (Vol.-1), Published by SBSRD, Allahabad (U.P.), (ISBN: 978-81-323535-2-4), Page No. 1-231.
- Pant, Hemlata; Singh, M. K., Srivastava, D.K. and Mathur, V. (2018): New Approaches in Agricultural, Environmental and Nutritional Technology (Vol.-2), Published by SBSRD, Allahabad (U.P.). (ISBN: 978-81-923535-3-4), Page No. 1-264.
- Chaturvedi VK, Singh A, Singh VK, Singh MP (2018). Review article “Cancer Nanotechnology: A New Revolution for Cancer Diagnosis and Therapy”. Current Drug Metabolism (IF-2.7).
- Kapoor, Neerja (2018) ‘Organic farming , Sustainability and Health’ article published in COJ Reviews & Research , Volume - 1, Issue -1, pages 1 – 5 ,Crimson Publishers (U S A), May 30, 2018. (International).
- Verma, R. (2018). Book Review of *Social Capital. Collectivism and Development in Journal Psychology and Developing Societies.* 30(1) Sage Publishers.
- Ahsaan, Md., (2019) Delineation of the Child's Mind in David Copperfield. International Journal of English Language, Literature in Humanities (IJELLH), Volume 7, Issue 3, March 2019.
- Ahsaan Md.,(2018) “Psychoanalytical Interpretation of Shakespeare’s Hamlet and Macbeth”, journal IJELLH, Vol. 6, issue 4th April, 2018.
- Anuradha and Krishna, A. Adiposity associated changes in serum glucose and adiponectin levels modulate ovarian steroidogenesis during delayed embryonic development in the fruit bat, *Cynopterus sphinx*. General and Comparative Endocrinology, Volume 262, 1, June2018, Pages 1-11. <https://doi.org/10.1016/j.ygcen.2018.02.016> (JCR impact factor (IF) = 2.56.
- Chaurasia, Himani. (2018). Insilico studies of 2- aryl benzimidazole derivatives a nucleoside averse transcriptase inhibitors (NNRTIS). Vigyan Parishad AnusandhanPatrika, ISSN No. 0505-5806.
- Chawla, P. and Tripathi, Mridula. (2018), Performance of chitosan based polymer electrolyte for natural dye sensitized solar cell. Environmental Progress & Sustainable Energy, DOI 10.1002/ep.12965.
- Grover, S. ;Srivastava, P., Verma, J. and Khan, A.S. (2018). Eco-taxonomical studies on diatoms from the Chambal river (Central India). International Journal of Plant Research; Plant Archive, 17 (2), 1517-1532ISSN . 0972-5210.
- Jaiswal, V., Fruit galls of *Asphondylia murrayae* sp. nov.(Cecidomyiidae:Diptera) on *Murrayakoenigii* from Lower Garhwal Himalaya. Bioved, 29 (1): 1-3, 2018.
- Kamaal, S.; Faizi, S.H.; Ali, A.; Ahmad, M.; Iskenderov, T. (2018), Crystal structure of 4-[3-methoxy-2-oxidobenzylideneOzaniumyl]benzoic acid methanol monosolvate, Acta Cryst. E74, 1847-1850.
- Khare, M.; Singh B. and Shukla A., Approximation in quantum measure spaces, Math. Slovaca, Walter de Gruyter GmbH, Germany, 68 (2018), 491-500.

- Kumar, A.; Climate Change and Climate Refugee : A lesson for the World , ISSN No.-2348-5485.
- Kumar, A.; Reservation in Promotion: A constitutional Puzzle, JIGYASA: An Interdisciplinary Refereed Research Journal, ISSN 0974 – 7648, UGC Approved Journal No – 40957 (IIJIF) Impact Factor- 4.172, Vo.I XI, No.2, June 2018.
- Kumar, Brijesh (2019) “A Study of Impact of Demonatisation on the Indian Economy”, Journal of Current Science Vol-20 Issue-1. ISSN : 9726-001X.
- Kumar, Brijesh (2018) “Bharat me Upphokatta ke Manvaadhikar ki vivechana” Shodh Pravaah. Vol-08 No. -02. ISSN : 2249-6742.
- Kumar, R.; Devanathan A.; Mishra, N L.; Rai, A K.(2019) Quantification of Heavy Metal Contamination in Soil and Plants near Leather Tanning Industrial Area using LIBS and TXRF, Journal of Applied Spectroscopy ,86:5, (Impact factor: 0.514), ISSN:0021-9037.
- Maurya, M. K. and Agarwal, M. (2018). Relationship between motivation to lead, mental health status, and job satisfaction of male and female civil police constables. Journal of police and Criminal Psychology, 33(1), 9-20. DOI: 10.1007/s11896-017-9230-4 (Publisher- Springer Nature, US).
- Maurya, M.K. (2018). Mental Health Status and Job Satisfaction of Male and Female Police Personnel in India. Indian Journal of Social Research. 59(1), 73-87.
- Maurya, M.K. (2018). Motivation to lead among police personnel in india: Does rank matter? Productivity: a quarterly journal of the national productivity council, 59(2), 131-137.
- Maurya, M.K. (2018). Relationship between demographic variables, life satisfaction, psychological wellbeing and psychological distress: a study with Indian research scholar. Indian journal of social research. 59(6), 867-878.
- Pandey, B.D., Surrogacy vi-a-vis Women’s Right”-Recent Trends in Research, ISBN: 978-93-86789-84-6(Page no.215-223)-2018-19.
- Pathak A K, Rai N K, Kumar R, A K Rai, C G Parigger, Gallstone Magnesium Distributions from Optical Emission Spectroscopy, Atoms (2018), 6(3):42,doi:10.3390/atoms6030042, ISSN: 2218-2004.
- Pathak, A. K., Singh, A., Kumar, R., Rai, A K, Laser-Induced Break down Spectroscopy Coupled with PCA Study of Human Tooth, National Academy Science Letters (2018) DOI 10.1007/s40009-018-0735-x,ISSN: 0250-541X.
- Pati K. and Varma R. (2017). A Psychosocial analysis of Sexual Harassment at Work Place in India. Ruminations. An International Journal for analysis and Research in Humanities and Social Sciences. 8(1) ISSN 2229-6751.
- Prakash, S. and Chaturvedi, A. K. (2019) Iso-Noetherian Rings and Modules, Communication in Algebra,
- Predrag S. Stanimirovic, Srivastava S. and Gupta D.K., From Zhang Neural Network to scaled hyperpower iterations, Journal of Computational and Applied Mathematics, Vol-331 (2018) 133-155 (Springer, SCI, Scopus), (Impact factor 0.868)(Elsevier, SCI, Scopus),(Impact factor 1.357), ISSN 0377-427.
- Rai, A K, Pati, J K, Kumar R., Spectro-chemical study of moldavites from Ries impact structure (Germany) using LIBS, Optics and Laser Technology (2019), 114:146-157, (Impact factor: 2.504), ISSN:0030-3992.
- Raizada, N.; Forensic science: Jurisprudential Perspective, JIGYASA: An Interdisciplinary Refereed Research Journal, ISSN 0974 – 7648, UGC Approved Journal No – 40957 (IIJIF) Impact Factor- 4.172, Vo.I XI, September 2018.
- Raizada, N.; Marital Conflicts & Forensic science, JIGYASA: An Interdisciplinary Refereed Research Journal, ISSN 0974 – 7648, UGC Approved Journal No – 40957 (IIJIF) Impact Factor- 4.172, Vol. XI, December 2018.
- Sahu, D.K. (2018). Synthesis and characterization of Cr(III) compounds with tetradentals N4 Macrocyclic Ligands. International Journal of Research in Chemistry and Environment, 8(1), 37-43.
- Saran N. A. (2018) “Magic Realism and Rushdie’s Shame”, Literary Endeavour (ISSN-0976-299x).
- Saroj, S. K. (2018) “A Mythical and Theatrical Perspective: Girish Karnard’s Hayavadana”. Journal of language in India, Serial No. 49042, ISSN NO. 1930-2940, Vol. 18.
- Saroj, S. K. (2018) “Culture and Language in the plays of Girish Karnard and Habib Tanvir: An Overview”. International Journal, ISSN NO. 0976-8165 in English Vol. Issue VI Dec 2018.
- Siddiqui, I.R.; Srivastava, Arjita; Srivastava, A; Shamim, S. and Shireen, Waseem, M.A. (2018) Ionic liquid promoted one pot approach for the synthesis of pyrido[1,2-c][1,3,5]thiadiazin-4-ones and thiazolo[3,2-c][1,3,5]thiadiazin-4-ones in water. Arabian Journal of Chemistry. 11(2), 256-264.
- Singh, A. K.; Kumar, S.; Vinayak, M. (2018) Recent development in antihyperalgesic effect of phytochemicals: anti-inflammatory and neuro-modulatory actions. Inflamm Res. DOI: 10.1007/s00011-018-1156-5. JCR IF: 2.99.
- Singh, M. K. and Pant, H. (2018): Influence of intercropping on root-gall nematode disease on Okra (*A. esculentus* L.) Jour. Nat. Res. Dev, Vol. 13 (1), Page No. 114-119.

- Singh, M.K. and Pant, H. (2018) : Influence of intercropping on root - gall nematode disease on okra, Jour. Nat. Res. Dev, 13 (1), 114-119.ISSN: 0974-5033
- Singh, N. K. (2019) "Prakritik Jal Shroto ka Aarthik Jeevan per Parbhav : Mughalkalin Bihar keVisheshSandarbh Mein" published in*Jal Jeevan aurSamaj*, Edited by Jibraeil , Published by Ane Books, Delhi, IS B N 978-93-88264-52-5.
- Singh, P. K.; Singh P. P. and Srivastava Vishal (2018) Facile Aerobic Photo-Oxidative Synthesis of Sulfinic Esters, *CroatiaChemica Acta*, 91(3), 383–387. DOI: 10.5562/cca3401.
- Singh, P., Kumar, R., Singh, A., Singh, A.K., Yadav, P., Khanna, R.S., Vinayak, M. and Tewari, A.K. (2018) Synthesis and crystal structure of quinolinium salt: Assignment on nonsteroidal anti-inflammatory activity and DNA cleavage activity. *Journal of Molecular Structure*, 1163, 262-269.
- Singh, P.; Kumar, R.; Singh, A. K.; Yadav, P.; Khanna R. S.; Vinayak, M.; Tewari, A. K. (2018) Synthesis and crystal structure of quinolinium salt: Assignment on nonsteroidal anti-inflammatory activity and DNA cleavage activity. *J Mol Struct.* DOI: 10.1016/j.molstruc.2018.02.115. JCR IF: 2.011.
- Singh, S. and Padhye S., A(2018) Self Proxy Signature Scheme over NTRU Lattices, *Information Technology- New Generations*, (SPRINGER, SCOPUS).
- Singh, S. and Padhye, S. (2018).A Self Proxy Signature Scheme over NTRU Lattices, *Information Technology – New Generations 2018. Advances in Intelligent Systems and Computing*, 738, Springer, SCOPUS.
- Singh, S. and Padhye S.,(2018) MaTRU-KE : A Key Exchange Protocol based on MaTRU Cryptosystem, *International Journal of Communication Systems*, (SCI).
- Singh, S. S., Copyright Issues in the Context of Computer Programme/ Software, *All India Reporter (AIR)*.
- Srivastava P.; Mondal, R. K. and Srivastava J.(2018) Soft Computing Information Systems for Diabetes Detection, *Periodicals of Engineering and Natural Sciences*.
- Srivastava S.P.(2018), 'Devgarh ki guptakalin vishishta vaishnac pratimayen', 'Meerayan, June- Aug. p.67-71.
- Srivastava, R. K.,(2018) 'The first feminist of the world-Marry Astell'. in the journal KIJELL .
- Srivastava, R. K.,(2018) 'Was Butcher original in his explanation of Universalization?', in KIJAHs journal.
- Srivastava, Vishal; Singh, P. K.; Kanaujia, S. and Singh, P. P. (2018) Photoredox catalyzed synthesis of amino alcohol. *New Journal of Chemistry*, 42, 688.
- Srivastava, Vishal; Singh, P.K.; Singh, P.P. (2019), Photocatalyzed Eosin-Y mediated C(sp³)-H alkylation of amine substrates via direct HAT, *Tetrahedron Letters*, doi.org/10.1016/j.tetlet.2019.04.016.
- Srivastava, Vishal; Singh, P.K.; Singh, P.P. (2019), Visible light photoredox catalyzed amidation of carboxylic acid with amines, *Tetrahedron Letters*, 60, 40-43.
- Srivastava, S.; Stanimirovic, P. S.; Katsikis, Vasilios N, and Gupta, D. K. (2018). A family of iterative methods with accelerated convergence for restricted linear system of equations. *Mediterranean Journal of Mathematics*, Vol-14 222 (Springer, SCT, Scopus), (Impact factor 0.868), (ISSN: 1660-5446 (print version), ISSN: 1660-5454 (electronic version).
- Tripathi, A.; Kumar, S.; Srivastava, S.K. (2018). The Active components of azadirachtaindica and its beneficial role in health management. *International Journal of Creative Research Thought*, 6(1), 1077-1080.
- Tripathi, J., Agrawal, U. R. and Tripathi, M., "Effect of thiourea on tissue damage in the larvae of *Sarcophaga sp.*" *International Research Journal of Biological Science Vol 7 (7), 35-38,* (2018). This paper won the RULA International Innovation & betterment Award, 2018.
- Verma, Jyoti; Srivastav, P. and Nautiyal, Prakash (2018). Ordination analysis for determining distributional patterns of diatom communities in different ecoregions of Indian subcontinent. *Bioscience Discovery*, 9 (1): 135-140. ISSN: 2231024x.
- Verma, Jyoti; Srivastava, P. and Pant, H. (2018) Distribution of Bacteriophyceae and it's composition in the foot hills of river Ganga, *Jour. Nat. Res. Dev.*13 (2),48-53,ISSN:0974-5033.
- Vishnu Dipti (2018)'Arthaptti praman: Mimansa ke sandarbh me' ' Shodh Navneet" *An Int. J. of Humanities and Oriental Knowledge*'p.256-258.
- Agrawal, B. (2018) "Insulin Plant: A medicinal plant with antidiabetic potential" In: "Advances in Chemical and applied sciences", Vol. 1; Ed. 2018 (Editors- Arti Gupta, Sunanda Das and Babita Agrawal) First Print Publications; ISBN: 978-81-9350520-5.
- Agrawal, B. (2018) "Need of Green Synthesis of metal complexes for environmental protection" in the book "New Approaches in Agricultural, Environmental and Nutritional Technologies Vol. II." published by SBSRD Allahabad, ISBN: 978-81-923535-3-1.

- Agrawal, S. and Agrawal, B. (2018) "Cytotoxic activity of lanthanide complexes" In: "Advances in Chemical and applied sciences", Vol. 1; Ed. 2018 (Editors- Arti Gupta, Sunanda Das and Babita Agrawal) First Print Publications; ISBN: 978-81-9350520-5.
- Agrawal, U.R.(2018) "Complete Food Technology: A feeding strategy for Livestock" –A Book Chapter in: New Approaches in Agricultural Environmental and Nutritional Technology Vol. I, published by SBSRD, Allahabad, pp.205-207 . ISBN: 978-81-923535-2-4.
- Ahmad N., "Novel Tukhm e Khoon ka Tajzia", in the book "Ikkiwinsadi me urdu novel edited by Moazzam Ali, Published by Rajasthan Urdu Academy (Rajasthan Government).
- Anjalika (2018) LegalJustifiability of Right to Food as Basic Principle of Human Rights. In: India's Strive For Food And Nutritional Security (Edited by K.K. Singh, Anjali Agrawal and R.P.Singh), pp 195-208.Nath Ram Publication, Varanasi, ISBN: 978-93-8-7321-09-0.
- Chaturvedi, V.K.; Kushwaha, A.; Chaurasia, H.; Maurya, S.; Singh, M.P. (2019) "Use of nanomaterials for removal of toxic wastewater treatment", Springer, Singapore (In Press).
- Chaurasia, H.; Singh, V.K.; Chaturvedi, V.K.; Mishra, R.; and Srivastava, V (2018) "Therapeutic potentials of nanomedicine for brain disorders" In "Advances in Neuropharmacology Drugs and therapeutics, AAP 7 CRC press, USA, ISBN: 9781771887977.
- Chawla, P.; Trivedi, S.; Pandey, K.; and Tripathi, Mridula (2018) 'Dielectric studies of [PEO: CH₃COOLi] graphite system synthesized by hot press and solution cast technique. Proceedings of national academy of sciences Indian Section A: Physical Sciences (2018) 88: 187-193.
- Das, Sunanda. (2018) "Food Security in India in 21st Century" in the book "New Approaches in Agricultural, Environmental and Nutritional Technologies Vol. II", published by SBSRD Allahabad, ISBN:978-81-923535-3-1.
- Das, S.; Mukerjee, S. and Shukla, A.K. (2018) "A brief review on preparation of spinels by co-precipitation method" In: "Advances in Chemical and applied sciences", Vol. 1; Ed. 2018 (Editors- Arti Gupta, Sunanda Das and Babita Agrawal) First Print Publications; ISBN: 978-81-9350520-5.
- Gaurav, G. 'Globalization and the Nation State' in book 'Globalized India: Contemporary Dialogue' edited by Archana S. Mathew &Tripti Mishra Kautilya Books, New Delhi, 2018.
- Gupta R., Kala Aur Sangeet (Page No. 261-272), Sangeet Pravah, Swar, kavya Tathachintan, Editor- EnaShashtri, Publisher- Navjivan Publication, Navjivan complex, Niwai(tonk- Rajasthan), India, 978-81-8268-203-0.
- Gupta, A. (2018) "Environmental Diseases" in the book "New Approaches in Agricultural, Environmental and Nutritional Technologies Vol. I" published by SBSRD Allahabad, ISBN:978-81-923535-3-1.
- Hamid, N.; Pant, H. and Ayoub Y. (2018): Biotechnology responsibility in meeting food deficiency, Published in New approaches in Agri, Envi& Nutritional Technology (Vol.-2 Book), Published by SBSRD, Allahabad (U.P.), Page No. 147-151 (ISBN : 978-81-923535-3-1).
- Pandey, Archana (2018) "Effect of phytochemicals on ageing brain" In: "Advances in Chemical and applied sciences", Vol. 1. (Editors- Arti Gupta, Sunanda Das and Babita Agrawal) First Print Publications; ISBN: 978-81-9350520-5.
- Singh, M. (2017). Bhartiya UdarvaadkePraneta. Ansika Publication, Allahabad, ISBN: 978-8193333327.
- Pant, H. and Singh, M. K. (2018): Woman Empowerment Through Cultivation of Mushroom: an Eco-friendly approach, Published in Proceedings (Ecological imbalance: A treat to flora, fauna, economy and human survival), Published by Department of Zoology, Govt. P.G. College, Saidabad, Allahabad, Page No. 100-106 (ISBN: 978-81-931262-2-6).
- Pant, H.; Singh, M. K.; (2018), Application of Nanotechnology in Agriculture and Environmental issues : An overview, Published in Advances in Chemical and Applied Sciences (Book), published from Chemical Society , CMP College, Allahabad, page no: 159-167,ISBN : 978-81-9350520-5.
- Pant, H.;Srivastava, D.K. and Singh, D. (2018): Methods of nematode management, Published in New approaches in Agri, Envi& Nutritional Technology (Vol.-1, Book), Published by SBSARD, Allahabad (U.P.), Page No. 147-151 (ISBN: 978-81-923535-2-4).
- Prakash, Gyan (2018) "Graphical Demonstration of missing spectra in double slit pattern" In: 'Advances in Chemical and Applied Sciences' edited by Arti Gupta, Sunanda Das, Babita Agrawal. P. 111-115, 2018. ISBN: 978-81-9350520-5.
- Saxena, V. L.,(2018)'State Initiatives, Developmentality and Lower Castes in Rural India: Analyzing mobility of Scheduled castes in rural Jammu Region, (J&K)', in 'B.K. Nagla & Vinay K. Srivastava (ed.) "Issues and Themes in Contemporary Society, Rawat Publication, New Delhi, (ISBN: 978-81-316-0993-4).

- Shukla, A.K. (2018) "Environmental Diseases" in the book "New Approaches in Agricultural, Environmental and Nutritional Technologies Vol. I" published by SBSRD Allahabad, ISBN:978-81-923535-3-1.
- Singh, D. K.; "Role of Mental Abilities in Learning of Biological Science".
- Singh, M.; (2018) "Role of Radioisotopes in medical and industrial area", pg. no. 190-192, New approaches in agricultural, environmental and nutritional technology, vol. 2 (Society of biological sciences and rural development).
- Singh, N. K. (2018) Satrahvi Shatabdi ka Bihar: Aarthik evam Samajik Jeevan, K.P. Jayaswal Research Institute, Patna, Govt. of Bihar, , ISBN 81-89785-19-2.
- Singh, P.K. (2018) "Antioxidants and human health: oxidants and antioxidants in organic chemistry" In: "Advances in Chemical and applied sciences", Vol. 1; Ed. 2018 (Editors- Arti Gupta, Sunanda Das and Babita Agrawal) First Print Publications; ISBN: 978-81-9350520-5.
- Singh, V.K.; Chaurasia, H.; Mishra, R.; Srivastava, R.; Chaturvedi, V.K.; Singh, R.K. (2019), "Natural products as anti- HIV agents and their role in HIV associated neurocognitive disorders" In "advances in Nutrition". AP 7 CRC Press, USA (In Press).
- Srivastava, A.; Kumar, R.; Tripathi, M.; Mandal, P. (2018) "Review on biomedical properties and applications of different copolymer micelle" In: "Advances in Chemical and applied sciences", Vol. 1; Ed. 2018 (Editors- Arti Gupta, Sunanda Das and Babita Agrawal) First Print Publications; ISBN: 978-81-9350520-5.
- Srivastava, D. (2018) "Check your water footprints" In: "Advances in Chemical and applied sciences", Vol. 1; Ed. 2018 (Editors- Arti Gupta, Sunanda Das and Babita Agrawal) First Print Publications; ISBN: 978-81-9350520-5.
- Srivastava, D. (2018) "Environmental Impacts of Renewable Energy Technologies" In "New Approaches in Agricultural, Environmental and Nutritional Technology: Volume 2" Editors: Dr. Hemlata Pant, Dr. Manoj Kumar Singh, Dr. D.K. Srivastava, Dr. Vandana Mathur, Publisher: Society of Biological Sciences and Rural Development, Allahabad, ISBN No. 978-81-923535-3-1, pp 200-208, published in 2018.
- Srivastava, R. (2018) "Environmental Diseases" in the book "New Approaches in Agricultural, Environmental and Nutritional Technologies Vol. I" published by SBSRD Allahabad, ISBN:978-81-923535-3-1.
- Srivastava, R.; Gupta A; (2018) "Telemedicine: A new horizon in healthcare systems" in the book "New Approaches in Agricultural, Environmental and Nutritional Technologies Vol. I" published by SBSRD Allahabad, ISBN: 978-81-923535-3-1.
- Srivastava, V. (2018) Engineering Chemistry: A Textbook. Alpha Science International Ltd, Narosa Publishing House Pvt. Ltd ISBN:- 978-1783323647.
- Srivastava, R. (2018) *Rushdie: The novelist*, Anshika Publication, Allahabad.
- Srivastava, R. (2019) "Vayu Pradushan" In "Paryavaran Satat Vikas aur Jeevan"; Editor- Deenanath Tiwari; Granth Academy, New Delhi; pp 178-187.
- Srivastava, R.; Gupta, A. (2018) "Boom time for biomaterials" In: "Advances in Chemical and applied sciences", Vol. 1; Ed. 2018 (Editors- Arti Gupta, Sunanda Das and Babita Agrawal) First Print Publications; ISBN: 978-81-9350520-5.
- Srivastava, R.; Gupta, A. and Saxena, A.R. (2018) "Acoustical studies of aspartic acid with aqueous D glucose solutions at different temperature" In: "Advances in Chemical and applied sciences", Vol. 1; Ed. 2018 (Editors- Arti Gupta, Sunanda Das and Babita Agrawal) First Print Publications; ISBN: 978-81-9350520-5.
- Srivastava, S.K. (2018) "Olive Oil Sources of Healthy Life" in "New Approaches in Agricultural, Environmental and Nutritional Technologies Vol. II." published by SBSRD Allahabad, ISBN:978-81-923535-3-1.
- Srivastava, S.K. (2018) "Two dimensional Nuclear magnetic resonance spectroscopy" In: "Advances in Chemical and applied sciences", Vol. 1; Ed. 2018 (Editors- Arti Gupta, Sunanda Das and Babita Agrawal) First Print Publications; ISBN: 978-81-9350520-5.
- Verma, J.; Srivastava, P. and Pant, H. (2018). Change detection in land use and land cover of Tehri reservoir in Uttarakhand; using Remote sensing data and GIS pp. 218-225 in New approaches in agricultural, Environmental and Nutritional Technology Vol. 2 edi., Pant et al. 2018. ISBN: 987-81-923535-3-1.
- Verma, J.; Srivastava, P. and Pant, H. (2018). Change detection in land use and land cover of Tehri reservoir in Uttarakhand; using Remote sensing data and GIS pp. 218-225 in New approaches in agricultural, Environmental and Nutritional Technology Vol. 2 edi., Pant et al. 2018. ISBN: 987-81-923535-3-1.
- Vishnu Dipti, (2018) "Rajasthaniya Sanskrit kathaon me samajik sandarbh" in Arvachin kavya evam kavyashastra, Akshyavat Prakashan, Allahabad. p.143-145.

- Mishra, D.; Agrawal, K. K.; Yadav, R. S.; and Srivastava, R.(2018) "Design of Out Pipe Crawler for Oil Refinery based on Analysis & Classification of Locomotion and Adhesion Techniques," IEEE UPCON, India, pp. 1-7. doi: 10.1109/UPCON.2018.8596988.
- Singh Y., and Mishra, S. K. (2018). Saddle Point Criteria for Semi-infinite Programming Problems via an Approximate Method. In: Operations Research and Optimization. FOTA 2016. (edited by Kar S., Maulik U., Li X.) Springer Proceedings in Mathematics and Statistics, Vol. 225. Springer, Singapore.
- Agrawal, Babita (2018) "Damaging Effects of Black Carbon on Climate", In: "CHEM-WORLD" vol-III, An Annual Bulletin published by Dept. of Chemistry, CMP college, Allahabad, p:16-21.
- Agrawal, Babita (2018) 'Report of Seven Days National Workshop on Antioxidants in Health and Disease Prevention', CHEM-WORLD Vol III, (2014-16).An Annual Bulletin published by Dept. of Chemistry, CMP college, Allahabad, p:31-33.
- Agrawal, Babita (2018) 'Report of Departmental Seminar (2014-16)', CHEM-WORLD Vol-III, An Annual Bulletin published by Deptt. of Chemistry, CMP college, Allahabad, p:53.
- Agrawal U.R. (2018) "Birds are Glorified Reptiles", ZOOLIFE Vol-V, An Annual Magazine Published by Deptt. Of Zoology, CMP College, Prayagraj, p:2-3.
- Das, Sunanda; (2018)"Interesting Facts About Some Elements in Periodic Table" CHEM-WORLD Vol III, (2014-16).An Annual Bulletin published by Dept. of Chemistry, CMP college, Allahabad, p. 4-8.
- Das, Sunanda; (2018) "Report: Social Responcibilities" CHEM-WORLD Vol III, (2014-16).An Annual Bulletin published by Dept. of Chemistry, CMP college, Allahabad, p. 34.
- Gupta, Arti (2018) "Impact of junk food on human health" in Cure Environmental Bulletin", vol. XXIV, ISSN: 2319-1333.
- Pandey, Archana; (2019) "Kumbh ka VaigyanikMahatv" in Vigyan-varsh 104, vol. 12 March 2019, ISSN-373-1200.
- Pandey Archana; (2018) "Health Benefits of SAME" in Chem-World 2014-16, Vol. III, Dept. of Chemistry, CMP Degree College, Allahabad.
- Pandey Archana (2018) "Rasaynikapshishton ka prabandhan" in Vigyan- varsh 104, vol. 03 June, ISSN-373-1200.
- Pandey, Archana; (2018) "Shoonya se shuru hua tha mera safar-Dr. Sharda Sundaram kijubani" in NayiAwaaz, volume 89, pp 35, ISSN- 2394-0115.
- Pandey, Archana; (2018) "Prakriti kechaukanewaaletathya" in Vigyan- varsh 104, volume 04 July 2018, pp- 20, ISSN-372-1200.
- Pandey, Archana; (2018) "Shrimati Aridaman ki radio katha" In NayiAwaaz, vol. 90, pp 32, ISSN- 2394-0115.
- Pandey, Archana; (2018) "Prof. Dinesh Mani ki vigyan sadhana" in Vigyan, varsh 104, vol. 08, pp-69-71, ISSN-373-1200.
- Prasad N.(January 2019),"Kumbh Mahatmaye aur Terthraj,Prayag", Hindustan Academy,Prayagraj. - ISSN:0378-391X
- Singh, A.K.; (2018) " Reactive Oxygen Species (ROS): Jekyll and Hyde Inside the Cell" An Annual Magazine Published by Deptt. Of Zoology, CMP College, Prayagraj, p:4.
- Srivastava, Roli; (2018) "Report: About Postgraduate Classes" CHEM-WORLD Vol III, (2014-16).An Annual Bulletin published by Dept. of Chemistry, CMP college, Allahabad, p.
- Srivastava, R., Gupta, A. and Shukla, A.K. (2018) "Stem Cell" CHEM-WORLD Vol III, (2014-16).An Annual Bulletin published by Dept. of Chemistry, CMP college, Allahabad, p.9-12.
- Srivastava, S. K. (2018) "Antioxidant Chemicals Presents in Fruits and Vegetables" CHEM-WORLD Vol III, (2014-16).An Annual Bulletin published by Dept. of Chemistry, CMP college, Allahabad, p.22-27.
- Tripathi, Mridula and Chawla, P. (2018) "Solar Energy: For The Service of Mankind" CHEM-WORLD Vol III, (2014-16).An Annual Bulletin published by Dept. of Chemistry, CMP college, Allahabad, p.28-30.
- Verma Jyoti and Pant Hemlata; (2018) "Ecosystem Services of Ganga: Its Conservation and Sustainable Management" An Annual Magazine Published by Deptt. Of Zoology, CMP College, Prayagraj, p: 5-6.

EWING CHRISTIAN COLLEGE

- Sanjay, S.S. (2019). Nanotechnology: VikasAthavaKranti pp, Sathyabhamasahityasansthan
- Gupta,A.D., Pandey. S., Jaiswal, V.K., Bhaduria, V. and Singh, H. (2019) Simultaneous oxidation and esterification of cellulose for use in water treatment containing Cu (II) ions. (Accepted Manuscript)

- Mishra, S.K., and Moses, A.S., 2018. Phytochemical screening and antifungal efficacy of closely related *Sennaobtusifolia* and *Sennatora* on some phytopathogenic fungi. Proc. Natl. Acad. Sci., India. Sect. B Biol. Sci. 88 (3) 1169 – 1175. (Springer)
- Singh, S.N., Moses, A.S. and David, A.D.M.. 2018. Antimicrobial activity of ginger and onion extracts against enteric pathogens. Journal of Pharmacognosy and Phytochemistry. 7 (6). 2653 – 2656.
- Singh, V.V., Naseer, A. and Moses, A.S.. 2018. Microbiological analysis of municipal supply water in Allahabad City. International Journal for Research in Applied Science and Engineering Technology. 6 (XI). 204 – 210.
- Naseer, A., Singh, V.V. and Moses, A.S.. 2018. Microbiological analysis of packed drinking water sold in Allahabad City. Journal of Emerging Technologies and Innovative Research. 5 (12). 759 – 771.
- Moses, A.S., Saurabh N. Singh, S.N., Pratap, D. and Shifa, S. 2019. Determination and Comparison of antimicrobial activity of *Psidiumguajava* and *Embllicaofficinalis* against MDR bacteria. Journal of Pharmacognosy and Phytochemistry. 8 (1). 2169 – 2172.
- Singh, S.N., Moses, A.S., and David, A.D.M.. 2019. Antimicrobial activity of *Embllicaofficinalis* extracts against selected bacterial pathogens. International Journal of Basic and Applied Research. 9 (1). 325 – 330.
- Singh, S.N., Moses, A.S., and Malhotra S. 2019. Isolation and partial purification of bacteriocin produced by *Lactobacillusacidophilus* strains. International Journal of Basic and Applied Research. 9 (2). 111 – 137.
- Amitabh Chandra Dwivedi, PriyankaMayank and R.K. Pathak. (2016). Size composition and exploitation structure of Indian major carp, *Cirrhinusmrigala* (Hamilton, 1822) from the Ganga river, India. *Journal of Fisheries and Life Sciences 1(1)*, 30 – 32.
- Srivastava S. and Kumar P. (2019), Extension of Groups using p telda –maps, National Academy Sciences Letters, ISSN0250-541X (<https://doi.org/10.1007/s40009-019-0788-5>).
- Shukla Sanjay Kumar (2018)*UppmanaKaSwaroopAurSvayattatta* (pp.171 – 184),Paramarsha, Volume 35, No. 1-4, ISSN: 2320-443.
- Shukla Sanjay Kumar (2018)*Metaphysico-Epistemological and Ethical Issues in Post-Modernity* (pp. 142 – 160).Dialogue, Volume 19, No.3, ISSN: 0973-0095.
- Shukla Sanjay Kumar (2018) *Problem of Mechanism and Teleology in Kantian Philosophy* (pp. 178 – 185), Madhyabharti, Volume 74, ISSN: 0974 – 0066.
- Shukla Sanjay Kumar (2018) *Perpetual Peace : Kant kaRajneetiDarsana*(pp.27 – 45), Unmilan, Volume 2, ISSN: 0974-0053.
- Sanjay, S.S. (2019). Safe nano is green nano. Green synthesis, Characterization and Applications of nanoparticles (edited by Shukla, A.K. and Iravani, S.) pp 27-34. Amsterdam, Elsevier.
- Zamen, G.S., Vidyapati and Sahae, J.P. (2018). Changing Paradigm in Teacher Education. Allahabad: Anubhav Publishing House

HAMIDIA GIRLS' DEGREE COLLEGE

- Siddiqui, Dr. Asma (2018). *E.M. Foster: Divine Connection*, Delhi, Bluerose Publication Press.
- Usmani, Naseha (2018). *Jauhar ki Ghazaliya Shaieri*, Naqsh-e-Nau, Vol-2, Issue-2, ISSN : 2320-3781
- Begum, Zareena (2018). *Akbar Allahabadi ki Shayeri me Ahtejaji Shaur*. Naqsh-e-Nau, International Annual Urdu Journal, Vol-2, ISSN : 2320-3781.
- Fatima, Nuzhat (2018) *Bhartiya Rastravad Ka Vikas*. Shodh Dhara, a peer reviewed Quarterly Research Journal of Humanities & Social Sciences Vol.3 ISSN: 0975-3664, UGC No. 41386 P.No.: 116-120
- Fatima, Nuzhat (2018) *Bhartiya Rastriya Andolan Mea Muslim Mahila Lekhikaon ki Sakreya Bhagidari*. Ayan, an International Multidisciplinary Refreed Research Journal. Vol.6.Iss.2, UGC No. 49095.P.No. 222-27.
- Fatima, Nuzhat (2018) *Kashful Mahjub : Tasawuf Par Ek Adewitiye Pustak*. Samkriti Sandhana, International Refreed Research Journal. Vol. XXXI, ISSN.0974-1526, UGC No. 2, P.No.150-157.
- Fatima, Nuzhat (2019) *Tareekh-e-Andlus Aur Allama Iqbal*. Ajkal, International Monthly Urdu Magazine. Vol.77, ISSN 0971-846X, P. No. 28-30.
- Akhtar, Gulshan (2018). *Impact of Tourism in India's Economic Development*, International Journal of Basic and Applied Research (COSMOS IMPACT FACTOR: 5.86). VOL.-3, Issue-5, Pp.28-37.
- Akhtar Gulshan (2019). *Impact of Health on Economic Development: An Indian Perspective*, International Journal of Scientific Research and Reviews, Vol.-3, ISN-2279-0543.
- Akhtar, Gulshan (2018). *Problems and Prospects of Agricultural Marketing in India : An Overview*, Sustainable Agriculture and Food Security, Issue-1, ISN-978-32-85022-35-7.

- Siddiqui, Asma (2018). Trinity of Faith: A Reading of *A Passage to India*, Humanism and Literature (edited by Vishwakarma, K. K) Pp 121-129. Yash Publishers & Distributors, Delhi. ISSN No. 978-93-84633-98-1.
- Fatima, Nuzhat (2019). *1857 Ki Ghatnaon Ko Satyapit Karne Wala Dulabh Srot : Zafarnama Tareekh-e-Ain-e-Akhtar*. ISBN: 978-81-7975-905-9.

ISWAR SARAN DEGREE COLLEGE

- Sengupta, Anita (2018), *Prof Mridula Tripathi ki samiksatmak Drishti – ek sahityikavdan* 1-251, Allahabad Iswar Saran P G College, Allahabad
- Pandey, Amita (2018), *Vaishvik Drishti se vaikalpik Matratva mamta hart (Surrofade Mother) ki vyvastha aur manvadhikar*, Vishwa Bharti (A critical study on Women in Global Prespective) (Anita Sengupta), 297-313, Allahabad, Iswar Saran P G College, Allahabad
- Sengupta, Anita (2018), *Prof Mridula Tripathi ki samiksatmak Drishti*, Aprajita (Anita Sengupta), 244-251, Allahabad, Iswar Saran P G College, Allahabad
- Gupta, Ruchi (2018), *Innovations in Financial sector : A paradigm shift to Indian Economy*, Innovations in Business Practices, 180-192, New Delhi, Bharti Publication, New Delhi
- Gupta, Ruchi (2018), *“Green Marketing in India-A step towards a safer world”*, SAARANSH-RKG Journal of Management, Vol.9 (2), 73-78, Ghaziabad, SAARANSH
- Gupta, Ruchi (2018), *“MSME in India: Catalyst to economic growth and development”*, IJPUB-International Journal of creative research thoughts,, Vol.6 (1), 1021-1027, Ahmedabad, IJPUB
- Gupta, Ruchi (2018), *“Creative Accounting Practices: A case study of Enron and Satyam Scandals”*, International journal of Research and analytical Reviews, Vol.5 (4), 238- 242, Bhavnagar, IJRAR
- Singh, Anand Shanker (2018), *Hindi Yavan Sikke : Ek Punarmulyankan*, International Journal of Scientific Research in Science & Technology, Vol.3 (8), 1488-1492, Rajkot, IJSRST
- Singh, Anand Shanker (2018), *Uposhat : Ek Vrat Vidhan*, Shodh Bharti,
- Sengupta, Anita (2018), *Bhakti ka darshanik chintan –panchratra agam k alok mein*, Ayan, Vol.1 (1), 136-139, Aurangabad, Bihar, Lok Manav Kalyan Samiti
- Sengupta, Anita (2018), *Akamav Adwitiya Brahm*, Parishilan, IX /Apr-Jun, 39-44, Varanasi, Suruchi Kala Samiti
- Sengupta, Anita (2018), *Bhavbhuti ke Natakon mein Vrittiya*, Pramana, Issue-20/Apr-Jun, 124-128, -,-
- Sengupta, Anita (2018), *Meghdoot ki Samiksha – Kavya Bimb Ki Drishti Mein*, Vidhan, Vol.1 /Mar 2018, 195-198, Allahabad, Rameshwar Nath Social welfare Foundation
- Sengupta, Anita (2018), *Sanskri Kavyon mein Pariniya Vyakaran ki Upapad Vibhaktiya*, Chintan, Issue-130/Apr-Jun, 100-103, -, Acharya Academy
- Sengupta, Anita (2018), *Kalhan Ki eitihisik Drishti –kashmir Ke Alok mein*, Ayan, Vol 6 (2) /Apr-Jun, 16-21, Aurangabad, Bihar, Lok Manav Kalyan Samiti
- Ahmed, Jamil (2018), *Purano mein nirupit bhugol, paryavaran, vanaspati evam khagol gyan – ek anushilan*, International Journal of Scientific Research in Science and Technology, Volume-4/Issue-5), 262-266, Rajkot, IJSRST
- Jaya Tripathi Jaya, Uma Rani Agrawal and Manisha Tripathi, *Effect of Thiourea on the tissue damage in the larvae of Sarcophaga Sp.*, International Research of Biological Sciences, Vol.7 (7), 35-38, Indore International Science Community Association
- Tripathi, R. C., Kumar, R., & Tripathi, V. N., *When the Advantaged Feel Victimized: The Case of Hindus in India*, *Psychology and Developing Societies*, 31(1), 31–55, New Delhi, Sage

JAGAT TARAN GIRLS' DEGREE COLLEGE

- Srivastava S., (2018) , *“Alexandria as a Source of Hellenisrtic Greek Prosperity”* , journal ‘Aitihya Journal of Ancient History culture and Archaeology, Vol 6-7 (2015-16), PP 89-94 ISSN 2277-808X.
- Yadav M.,(2018) *Devgarh ke Dashavtar Mandir mein Ram Katha ka Ankan”* journal ‘Anhad Lok’ Pratidhwani Kala Sanskriti ki, Vol 8 (year -4) ISSN 2349-137X, PP 200.
- Bhattacharya R., (2019), *Keats Later Poetry: Contemporary Critical Views”* Journal (Vidyavarta International Multilingual Refereed Journal) Vol 2, PP 22-25, ISSN 2319-9318.

- Bhattacharya R., (2019), "Kumbha Mela: Role in National Integration" Journal (Vidyavarta International Multilingual Refereed Journal) Vol 1, ISSN 2319-9318.
- Bhattacharya R., (2019), "Literature and Environment An Eco Critical Study" International Journal of Research and Analytical Reviews (IJRAR), Vol 6, PP 771-775, ISSN 2349-5138.
- Bhattacharya R., (2019), "Marginalisation: Indian and Global Issues" International Journal of Research and Analytical Reviews (IJRAR), Vol 6, PP 681-684, ISSN 2349-5138.
- Bhattacharya R., (2018), "Post Modernist Approach of Kannada Hayavadana" Sodha Drishti, Vol 9, PP 106-108, ISSN 0976-6658
- Bhattacharya R., (2018), "Social Concerns in Novels: Contemporary Context" Printing Area International Multilingual Refereed Journal, Vol 2, PP 79-81, ISSN 2394-5303.
- Bhattacharya R., (2018), "Reflection of Values: Literary Aspects." Journal of Contemporary Research, Vol 5, PP 65-70, ISSN 2393-8538.
- Chaitanya P., (2018), "The Politics of being a Women: A Study in Shweta Mishra's What is a Women : Leave it, its Trash." New Academia: An International journal of English language, Literature and literary Theory, Vol VII, Issue II, PP 16-20, ISSN 2347-2073.
- Verma R.K., (2018), *Lok Sanskriti mein Ram: Awadh ke vishesh Sandarbh mein* journal 'Anhad Lok: Pratidhwani Kala Sanskriti ki" Vol 8, ISSN 2349-137X, PP 204-209.
- Verma R.K., (2018), *Maithali Sharan Gupt ke Sahirya mein Nari Ka Swaroop* journal 'Bhartiya Samaj mein Mahilaon ki Badaliti huyi Sthiti", ISBN 978-93-84999-87-2, PP 17-23.
- Sahgal S., (2018), *Bhartiya Sanskriti mein Ram ke bhajno ki Mahatta* in *Anhad Lok : Pratidhwani Kala Sanskriti ki* Vol 8, ISSN 2349-137X, PP 213-216.
- Bahradwaj K.,(2018) "Gender and Matriliney in North East India: A Critical Analysis" journal 'Arts & Education: International Research Journal, ISSN 2349-1353,
- Singh Rohit, Jha Darshan Kumar and Ayala, Johanna (2018): Water transportation, Boat and Dock Development: A Case studies of Varanasi City, *Indian Research Journal of Social Sciences*, Vol 34, No. 02, PP 190-194.
- Mishra A. (2019) *Rigveda kaleen Sanskriti*, on journal Anvikshiki research Journal, Vol 1, pp 1-3, ISSN 0973-9777
- Laxmi V., (2018), titled "*Brajbhumi aur Krishna bhakti: Ek Dusare ke Paryay*" International journal 'Anvikshiki' . pp 8-9, ISSN 0973-9777.
- Mishra S.,(2018) "*Vinay Patrika mein Tulsi ke Ram*" journal '*Kanljayi aur Yuva*'
- Arya P.,(2019) : Sanskrit aur Maithli ka Bhashagat Antahsambandh, An International Multidisciplinary Refereed Journal, Vol 7, pp 47-49, ISSN 2347-4491.
- Arya P.,(2019): *Niruktdisha Agnipad vivechanam*; The Journalist, vol 3&4, ISSN 2231-2943.
- Dwivedi P. (2018); *Prithivi Sukta mein Paryaan ki Avadharna*; The Journalist,
- Dwivedi P. (2019); Prof. hari Dutta Sharma ki '*Utkalika*' *Vastutah Bhavon ki Utkalika*; Shri Prabhu pratibha,
- Ranjan, P., & Singh, S. N. (2018). Access to Information Resources by Biomedical Scientists in India in Digital Era. *Library Waves*, 4(2), 78-89.
- Ranjan, P., & Singh, S. N. (2018). Library Use by Biomedical Scientists in India in Digital Era. *International Journal of Information Dissemination and Technology*, 8(4), 179-184.
- Ranjan, P., & Gudi, S. (2018). Cost Effectiveness of AICTE Mandatory E-Resources in Rajarshi Shahu College of Engineering (RSCOE) Central Library, Pune (India): A Case Study. *International Journal of Information Dissemination and Technology*, 8(3), 157-160.
- Ranjan, P. (2018). Industry 4.0 and industrial information services in India: A proposal. *ABS International Journal of Management*, 6(2), 74-77
- Ranjan, P., & Singh, S. N. (2019). Status of Libraries in Internet Age. *International Journal of Information Dissemination and Technology*, 9(1), [ACCEPTED]

- Jha D.K. 2018 Relation between Urbanisation and Urban Poverty in India: A Spatioemporal Analysis In Tripathi, V.K. Jha, D.K. And Harshvardhan, R. (eds) 2018. Advance in Urban Studies in India, RK Books, New Delhi; pp 237-251.
- Verma A.K. 2018 “Vaishvikaran Evam Rojgar Ke Naye Awasar” Vaishvikarn Ke Vividh Ayam : Bhartiye Paridrishye, Delhi, Yash Publishers & Distributers, ISBN 978-93-85689.
- Srivastava S., (2018), *Pracheen Bharat Mein Jain Dharma ke vikas mein Striyon ka Avadan: Pashchimi evam Dakshin Bharat ke Vishesh Sandarbh mein*” International Seminar on Changing Status of Women in Indian Society, PP 6-9, Allahabad
- Yadav M.,(2018) “Mahila Sashaktikaran ke Sandarbh mein Paramparik Mantaon aur Adhunik Vichardhara ka Takraav” proceedings ‘Changing Status of Women in Indian Society, PP 14, Allahabad, ISBN 978-93-84999-87-2
- Gupta N., (2018) “Studying Bihari and Bengali Women in respect of Marital Adjustment” proceeding ‘Indian Women in Contemporary Society Challenges and Solutions, ISBN 978-93-96846-69-3, PP 40-46. New Delhi
- Gupta N., (2018) “Vaidik Shitya mein Nirupit Nari” proceeding ‘Changing Status of Women in Indian Society” . ISBN 978-93-8499-87-2, PP 121-124. Allahabad.
- Deb N., (2018) “The Contribution of Hindi Cinema in Popularizing Indian Classical Music”, proceedings “Evaluation of Indian Cinema Part I, ISBN 978-93-86556-06-6, PP 227-233, New Delhi.

K. P. TRAINING COLLEGE

- **Srivastava, A.** Published a Paper Titled “A study of Environmental Awareness among arts and science graduate students of Allahabad District” Page No. – 16 to 18 in International Journal of Management and applied science ISSN:- 2394-7926 Vol – 4 Issue – 10 October 2018 Impact Factor 4:1
- **Gurtu, N.** Published a Paper Titled “Significations of Cloud Computing” in Techno Learn - an international journal of educational technology ISSN No. – 2249-5223
- **Pandey, R.** Published a Paper Titled “छात्रों के मानवाधिकार एवं शिक्षा के अधिकार अधिनियम का क्रियान्वयन” in International Journal of Education Technology and Social Media ISSN No. 2321-0885 VIII (I), 2019
- **Sahoo, N.** Published a Paper Titled “Attitude of in Service Teacher Participants towards online diploma elementary education programme of NIOS, India Page No. – 1144-52, Open Education in Human Resource Development in Asia Period of Integration, 30nd annual conference of AAOU, Vol. – II, Bach Khoa Publication House Hanoi 26-26 Oct. 2018.
- **Srivastava, S.** Published a Paper Titled “Social Justice and Women Empowerment” Page No. – 160-164, in the book named Social Justice, Development and Democracies: Challenges and Opportunities, ISBN – 978-93-83762-97-2, New Delhi.
- **Singh, P.** Published a Paper Titled “शिक्षित बेटियाँ : सशक्त देश” Page No. – 254-256, in the book named Social Justice, Development and Democracies: Challenges and Opportunities, ISBN – 978-93-83762-97-2, New Delhi.
- **Sahoo, N.** Published a Paper Titled “Attitude of in Service Teacher participant towards online Diploma Elementary Education Programme of NIOS India” Page No. – 11440-51 in Asia’s period of Integration, The 30 Second Annual Conference of the AAOU Vol.II Bachkhwa, Hanoi 24-26 October 2018 ISBN No. – 978-604-95-0635-2
- **Sahoo, N.** Published a Paper Titled “Women Empowerment: A Social Justice” Page No. – 75-78 in the book named Social Justice, Development and Democracies: Challenges and Opportunities, ISBN – 978-93-83762-97-2, New Delhi.
- **Sharma, S.** Published a Paper Titled “Social Justice Challenged: Child Labour” Page No. – 102-106 in the book named Social Justice, Development and Democracies: Challenges and Opportunities, ISBN – 978-93-83762-97-2, New Delhi.

RAJARSHI TANDON MAHILA MAHAVIDYALAYA

- Jaiswal, S.(2018). Vittiya Samaveshan tatha Gramin Vikas. Deliberative Research Journal, 39,1-5.
- Srivastava, K., (January 2019). Hindi Patti main Swadeshi Chetna, Navjagnti Evam Rashtriya Dhara Ke Purakarta Bhartendu Harishchandra Sahitya Viklpa,5,15-19.

- Yadav, N., (2018) Bhartiya Sangeet Main Shri Ram, Anhadlok : Pratidhwani Kala evam Sanskriti Volume No. 7, 86-90
- Yadav, N., (2019) Kaushambi Ki Mrad Murtiyon Ka Sangeetik Adhyayan. KUTABH, 1, 55-62
- Tandon ,P.(2018). उपन्यास में नियतिवाद का दार्शनिक पक्ष. श्री वेदाङ्ग-वीथी शोधपत्रिका.I, 9-12.
- Tandon ,P.(2018). संस्कार ही आदर्श समाज की आधारशिला, Remarking An Analisation. III 224-226.
- Singh, N. (2018). An Analysis of Domestic Violence Against Women in India and Protection of Women from Domestic Violence Act 2005.In: Human Rights and Challenges of Women In India. Edited by N. B. Sharma).pp 359-369 Nainital : Centre for Women Studies, Kumaun University.
- Srivastava, K. (2018) Vaishvikaran Ke Daur Main Hindustani Cinema. Evolution of Indian Cinema (edited by Madhurani Shukla). pp 95-98.New Delhi : Kanishka Publishing House.
- Mehrotra, R. (2018). Akashvani Sangeet Sammelan- Ek Mahan Uplabdh. In: Shraddhanjali (edited by Dr.R.Johri). pp 113-116. , Varanasi : Luminous Books.
- Mehrotra, R. (2018). Cinema mein Shashtriya Sangeet (Gaayan aur Vaadan) ki Prasangikta. In: Evolution of Indian Cinema (edited by- Madhurani Shukla). pp 117-121. New Delhi: Kanishka Publishing House.
- Yadav, N.(2018) Vartman Yug Main Vritik Mahila Sangeetkaron Ke Liye Avsar.Istri Vimarsh Ka Prachya Evam Adhunik Sandarbh,National Seminar. pp. 71-73. Ishwar Saran Degree College University of Allahabad.
- Yadav, N.(2018) Shastriya Sangeet tatha Film Sangeet.Bhartiya Cinema Ki Vikas Yatra,National Seminar.pp. 99-106. Vyanjana Art and Culture Society, Allahabad.

SADANLAL SANWALDAS KHANNA GIRLS' DEGREE COLLEGE

- Agrawal, Meenu (2019). Kumbhparv aur Prayag ki virasat. Sahitya Sangam
- Parveen, Tahira (2018). Urdu sahitya: Aurat ke haq me nayi awazen. Hindustani Academy
- Singh, Lalima, Sachdev, Neerja and Singh, Vikas (2018). Absolute Swaraj. Authorspress.
- Singh, Lalima (2018). Anveeksha Research Journal of SSKGDC. SSKGDC
- Agnihotri, Manoj Kumar (2018). Boolean circuit graph within consideration of Boolean Logic diagram, International Journal of Advanced Research & Development, 3, 197-199
- Agnihotri, Manoj Kumar (2018). A study of interconnection between Boolean algebra and binary tree. Globus: An International Journal of Management & IT, 9(2)
- Agrawal, Meenu (2018). Pracheen bharat me matsya aur matsyavatar, Journal of Gujarat Research Society, LXIII, 1-4
- Agrawal, Shikha (2019). Sustainable development of Indian economy: A special reference to Green Banking, International Journal of Research and Analytical Reviews, 6(1), 547-556
- Anand, Shruti (2019). Analytical study of social aspects of organized retailing related to customers, Vidyawarta (Special issue), 21-26
- Kumar, Surendra (2018). Micro teaching practices adopted for development of teaching competencies among teacher trainees through ODL module, International Journal of Research in Economics and Social Sciences, 8, 393-413
- Kumar, Surendra (2018). Study of practice teaching processes adopted for development of teaching competencies through ODL module, International Journal of Creative Research Thoughts, 6,723-735
- Kumar, Surendra (2018). Use of teaching methods at higher education institution, Scholarly Research Journal for Interdisciplinary Studies, 5(43), 9328-9333
- Rastogi, Shalini (2019). Self-realization of an autonomous identity, Global Journal of Research Analysis, 8(1)
- Roy, Tanushree (2018). Wildlife tourism in India: A potential tool for sustainable development, Ajanta, VII (IV), 1-11
- Singh, Anuradha *et al.* (2018). *In silico* studies on N- (Pyridin-2-yl) Thiobenzamides as NNRTIs against wild and mutant HIV-1 strains, Philippine Journal of Science, 147(1), 37-46

- Singh, Anuradha *et al.* (2018). Design, synthesis and antibacterial activity of novel heterocyclic arylsulphonamide derivatives, *Interdisciplinary Sciences: Computational Life Sciences*, 10, 748-761
- Singh, Anuradha *et al.* (2018). *In silico* studies on new oxathiadiazoles as potential anti-HIV agents, *Gene Reports*, 14, 87-93
- Singh, Anuradha *et al.* (2018). Molecular modeling, synthesis, antibacterial and cytotoxicity evaluation of sulfonamide derivatives of benzimidazole, indazole, benzothiazole and thiozole, *Bioorganic & Medicinal Chemistry*, 26, 3414-3428
- Singh, Anuradha *et al.* (2018). Synthesis, antibacterial activity, synergistic effect, cytotoxicity, docking and molecular dynamics of benzimidazole analogues, *Computational Biology and Chemistry*, 76, 1-16
- Singh, Harish Kumar (2018). Study of sarva shiksha abhiyan in the terms of community participation, *International Journal of Creative Research Thoughts*, 6(2), 1441-1448
- Singh Lalima (2018). Divyang and the Indian Constitution: An analysis of the beneficial provision, *Voice of Research*, 7(3), 25-28
- Singh Lalima (2018). Women and human rights: Indian Perspective, *International Journal of Research and Analytical Reviews*, 5(4), 391-395
- Singh, Rashmi (2018). Reviewing the literature: A critical review, *Anthology: The Research*, 3(4), 28-31
- Singh, Rashmi (2019). The three MS of Menstruation: Myths, Mysteries and Misconception, *Vidyawarta (Special Issue)*, 32-36
- Singh, Sippy *et al.* (2018). Distribution of non-pyramidal neurons in the frontal lobe of Indian Gray mongoose (*Herpestes edwardsii*), *Proceedings of the National Academy of Sciences, India, Sec.B. Biological Sciences*, 88(1), 209-217
- Singh, Sippy *et al.* (2018). Diversity and characteristics of neurons observed in medial hippocampus (HCm) of blue jay (*Coracias benghalensis*), *International Journal of Zoological Investigations*, 4(2), 174-180
- Singh, Sippy *et al.* (2018). Study of neuronal spacing across the season within the corticoid complex of female Indian ring neck parrot, *Psittacula krameri* (Scopoli 1769), *National Academy Science Letters (Springer)*, DOI.10.1007/s40009-018-0750y
- Srivastava, Meenakshi (2018). A study of absenteeism in context of students discontent with the classroom learning environment, *International Journal of Creative Research Thoughts*, 6, 1096-1106
- Srivastava, Meenakshi (2018). Factors causing student absenteeism according to school climate, *Voice of Research*, 7(3), 1-2
- Tandon, Richa *et al.* (2018). Krishi se matsya palan tak bahumukhi Loktak jeel, Kheti, ICAR, Awaran 2-3
- Yadav, Preeti (2018). Scenario of maternal health in India: An analysis of NHFS-4, *Journal of Emerging Technologies and Innovative Research*, 5, 371-379
- Agrawal, Meenu (2018). Allahabad ki Sanskritik virasat. In: *Anveeksha* (edited by L. Singh). pp. 76-78. Allahabad, India: SSKGDC
- Agrawal, Meenu (2018). Bhartiya sanskriti ki sanatan den. In: *Absolute Swaraj* (edited by L. Singh, N. Sachdev and V. Singh). pp. 114-119. New Delhi, India: Authorspress
- Agrawal, Meenu (2018). Kaushambi se prapt baudh abhilekh. In: *New horizons in Indology*, H.G Shastri, Commemoration Volume (edited by B. Shelet and T. Parmar). pp. 277-284. California, USA: Shri Nandan H. Shastri
- Agrawal, Shikha (2018). Indian Economy: A shift from cash to cashless. In: *Absolute Swaraj* (edited by L. Singh, N. Sachdev and V. Singh). pp. 370-384. New Delhi, India: Authorspress.
- Agrawal, Shikha (2019). Women Entrepreneur: Opportunities & Challenges. In: *Gender & Environmental Sustainability: Different Approaches* (edited by M. Bhattacharya and S. Mishra). pp. 147-157. Agra, India: Nikhil Publishers & Distributors
- Baijal, Jyoti (2019). Redefining the cultural traditions march towards environmental Sustainability. In: *Gender & Environmental Sustainability: Different Approaches* (edited by M. Bhattacharya and S. Mishra). pp. 37-50. Agra, India: Nikhil Publishers & Distributors

- Gupta, Pramila (2018). Radioactive waste management in context to Swachh Bharat Mission. In: Absolute Swaraj (edited by L. Singh, N. Sachdev and V. Singh). pp. 228-239. New Delhi, India: Authorspress
- Jyoti, Archana (2018). Drinking water quality: Issues and approaches. In: Absolute Swaraj (edited by L. Singh, N. Sachdev and V. Singh). pp. 173-182. New Delhi, India: Authorspress
- Jyoti, Archana (2019). Polymers: Molding the past, shaping the future. In: Advances in Chemical and Applied Sciences (edited by A. Gupta, S. Das and B. Agrawal). pp 93-99. Allahabad, India: First Print Publications.
- Kapoor, Jyoti (2018). Arvacheen sanskrit-Kavyashastra me kavya swaroop. In: Arvacheen Sanskrit: Kavya Avam Kavyashastra (edited by S. Agrawal). pp. 233-237
- Kapoor, Jyoti (2018). Bhartiya samaj me nari ka sashakt swaroop. In: Bhartiya Samaj Me Mahilaon Ki Badalti Hui Sthiti (edited by P.K. Kesarwani). pp. 10-13
- Malviya, Alok (2018). Effect of green house effect and global warming and change in environment by pollution with special reference to India. In: Absolute Swaraj (edited by L. Singh, N. Sachdev and V. Singh). pp. 78-84. New Delhi, India: Authorspress
- Malviya, Ruchi (2019). Environmental concern with particular reference to William Wordsworth. In: Gender & Environmental Sustainability: Different Approaches (edited by M. Bhattacharya and S. Mishra). pp. 141-146. Agra, India: Nikhil Publishers & Distributors
- Malviya, Shubhra (2018). Physiological effect of yoga in stress management practices. In: Absolute Swaraj (edited by L. Singh, N. Sachdev and V. Singh). pp. 257-263. New Delhi, India: Authorspress
- Pandey, Shashi (2018). Government initiatives towards women's health in India. In: Absolute Swaraj (edited by L. Singh, N. Sachdev and V. Singh). pp. 56-62. New Delhi, India: Authorspress
- Parveen, Shabnam (2018). Moringa: Concerning nutrition and environment. In: New Approaches in Agricultural, Environmental and Nutritional Technology (Vol.I) (edited by H. Pant, D.K. Srivastava and P. Singh). pp. 132-133. India: Society of Biologia
- Parveen, Shabnam (2018). Socio-economic factors affecting agricultural and household food. In: Absolute Swaraj (edited by L. Singh, N. Sachdev and V. Singh). pp. 472-478. New Delhi, India: Authorspress
- Parveen, Shabnam (2019). Chemical fossil: A biomarker. In: Advances in Chemical and Applied Sciences (edited by A. Gupta, S. Das and B. Agrawal). pp 253-256. Allahabad, India: First Print Publications.
- Rahman, Akhlaqur *et al.* (2019). Algal based CO₂ sequestration. In: Role of Photosynthetic microbes in Agriculture and Industry (edited by K. Tripathi, N Kumar and G. Abraham). pp 85-104. New York: Nova Science Publishers.
- Rahman, Akhlaqur *et al.* (2019). Biosynthesis and biotechnological potential. In: Role of Photosynthetic microbes in Agriculture and Industry (edited by K. Tripathi, N Kumar and G. Abraham). pp 219-235. New York: Nova Science Publishers.
- Rahman, Akhlaqur *et al.* (2019). Recent advance in the production and purification technology of phycobiliproteins: A sustainable approach In: Role of Photosynthetic microbes in Agriculture and Industry (edited by K. Tripathi, N Kumar and G. Abraham). pp. 173-193. New York: Nova Science Publishers.
- Sachdev, Neeraja (2018). Prison, voices: A cry from juvenile. In: Absolute Swaraj (edited by L. Singh, N. Sachdev and V. Singh). pp. 424-433. New Delhi, India: Authorspress.
- Sahgal, Sumita (2018). Chemistry of stress. In: Absolute Swaraj (edited by L. Singh, N. Sachdev and V. Singh). pp. 152-160. New Delhi, India: Authorspress
- Sahgal, Sumita (2019). Nano vehicles: A versatile anticancer drug delivery platform. In: Advances in Chemical and Applied Sciences (edited by A. Gupta, S. Das and B. Agrawal). pp 213-220. Allahabad, India: First Print Publications.
- Seth, Nishi (2019). Environmental awareness in vedic literature. In: Gender & Environmental Sustainability: Different Approaches (edited by M. Bhattacharya and S. Mishra). pp. 81-85. Agra, India: Nikhil Publishers & Distributors
- Singh, Anuradha *et al.* (2018). Human immunodeficiency virus reverse transcriptase (HIV-RT) and structural implications for drug development. In: Research Advancements in Pharmaceutical, Nutritional and Industrial

Enzymology (edited by P.K. Chaurasia and S.L. Bharati). DOI: 10.4018/978-1-5225-5237-6.ch005. USA: IGI Global

- Singh, Durgesh and Singh, Sippy (2018). Effect of smog on the brain. In: Absolute Swaraj (edited by L. Singh, N. Sachdev and V. Singh). pp. 283-290. New Delhi, India: Authorspress.
- Singh, Harish Kumar (2018). Quality on Teacher Education. In: Changing paradigm of the teacher education programmes in the present era (edited by J.S. Zamen, Vidyapati and J. Sahae). Allahabad, India: Anubhav Publications
- Singh, Preeti (2018). Zinc nutrition and plant growth. In: Advances in Chemical and Applied Sciences (Vol. 1) (edited by A. Gupta, S. Das and B. Agrawal).pp 178-183. Allahabad, India: First Print Publications.
- Singh Lalima (2018). Changing status of women: A peep into the past and future. In: Aprajita (edited by A. Sengupta and L. Singh). pp.229-236. Allahabad, India: I.S.D.C.
- Singh Lalima (2018). Food and Nutrition Security in India: Issues and Challenges. In: Absolute Swaraj (edited by L. Singh, N. Sachdev and V. Singh). pp. 99-113. New Delhi, India: Authorspress.
- Singh Lalima (2019). Women & Environment. In: Gender & Environmental Sustainability: Different Approaches (edited by M. Bhattacharya and S. Mishra). pp. 51-64. Agra, India: Nikhil Publishers & Distributors
- Singh, Rashmi *et al.* (2018). Making a difference through Edupreneurs- A Buisness paradigm shifting. In: Absolute Swaraj (edited by L. Singh, N. Sachdev and V. Singh). pp. 313-324. New Delhi, India: Authorspress.
- Singh, Rashmi *et al.* (2018). Yoga: A proven therapy to combat stress and psychological refinement. In: In: Absolute Swaraj (edited by L. Singh, N. Sachdev and V. Singh). pp. 131-144. New Delhi, India: Authorspress.
- Singh, Swastika (2018). Waste management: Recycling happens in India. In: Absolute Swaraj (edited by L. Singh, N. Sachdev and V. Singh). pp. 161-172. New Delhi, India: Authorspress
- Srivastava, Achala (2018). A class of high polymer: Plastic. In: Advances in Chemical Applied Sciences (Vol. 1) (edited by A. Gupta, S. Das and B. Agrawal). pp. 271-274. Allahabad, India: First Print Publication
- Srivastava, Achala (2018). Solid waste management in urban India. In: Absolute Swaraj (edited by L. Singh, N. Sachdev and V. Singh). pp. 63-71. New Delhi, India: Authorspress.
- Srivastava, Sheo Shankar and Kapoor, Jyoti (2018). Kuposhan ka swasthya par prabhav. In: Absolute Swaraj (edited by L. Singh, N. Sachdev and V. Singh). pp. 145-151. New Delhi, India: Authorspress
- Tandon, Richa (2018). Algae are the best. In: Bioprospecting of Algae (edited by M.N. Noor, S.K. Bhatnagar and S.K. Sinha). pp. 309-316. Meerut, India: Society for Plant Research India
- Tripathi, Archana and Shukla S.S. (2018). Food security in India: The challenges of feeding millions: a status review. In: Absolute Swaraj (edited by L. Singh, N. Sachdev and V. Singh). pp. 413-423. New Delhi, India: Authorspress.
- Agrawal, Meenu (2018). Rajneeti aur prashashan aur mahilaye, atit ke sandarbh me. National seminar proceedings on Changing Status of Women, 29-36. Allahabad

SHYAMA PRASAD MUKHERJEE GOVT. DEGREE COLLEGE

- Yadav, Himanshu Kumar (2018), Bharat Pak Sambandh : Atank Se Surgical Strike Tak, Raj Publication, New Delhi, ISBN : 978-93-82281-91-7
- Singh, Kirti Kumar (2018) , Adbhut Prem Kathayen, Vani Prakashan, New Delhi.
- Singh, Kirti Kumar (2018) , Dastan Dar Dastan , Vani Prakashan, New Delhi.
- Singh, Kirti Kumar (2018) , Meri Pratinidhi Laghu Kathayen , Vani Prakashan, New Delhi.
- Pandey, BK, TN Bhat, B Roul, KK Nanda, SB Krupanidhi , BTO/GaN heterostructure based on Schottky junction for high-temperature selective ultra-violet photo detection, Journal of Physics D: Applied Physics 51 (4), 045104, 2018.

RESEARCH PROJECTS

DEPARTMENT OF EDUCATION

S. No.	Title of Project	Duration	Funding Agency	Total Amount	Principal Investigator
1.	Innovative Teaching Learning and Evaluation Practices in the Best Rated Higher Education Institutions by NAAC.	1-4-2018--31-3-2023	UGC-SAP DRS-II	52.50 lakhs	<ul style="list-style-type: none"> Prof. P.K.Sahoo Co-Investigator-Prof. Dhananjay Yadav

Funding received during the Period

S.No.	Agency	Purpose	Amount
1.	UGC-SAP DRS-II	Up gradation of IT resources, conference , seminar, training	52.50 lakhs

DEPARTMENT OF MEDIEVAL AND MODERN HISTORY

S.N.	Title of Project	Duration	Funding Agency	Total Amount	Principal Investigator
1.	Dalits in Nehruvian Era (1947-1964)	Three Years	UGC	7.57 Lakhs	Prof Alok Prasad
2.	Leather Working Castes and English East India Company in Madras (17 th and 18 th centuries)	One Year	ICHR	I Lakh	Dr Vikram Harijan

DEPARTMENT OF PSYCHOLOGY

S.No.	Title of Project	Duration	Funding Agency	Total Amount	Principal Investigator
1.	Adherence to medical regimen among type 2 diabetes mellitus (DM) patients: Role of psychosocial factors	2015-18	UGC	Rs. 10,34,400	Prof. Neena Kohli
2.	Religious Practices and their influence on individual wellbeing and environmental ethics: The case of pilgrimage tourism by Ganges		Penn State New Kensington	\$ 7,000	Dr. C. Buzinde, Dr. J. Kalavar & Prof. Neena Kohli

DEPARTMENT OF URDU

S.N.	Title of Project	Duration	Funding Agency	Total Amount	Principal Investigator
1.	Dr. S. Radha Krishnan	3 years	UGC	1,19,000.00	Prof.A.A.Fatmi

DEPARTMENT OF ECONOMICS

S.N.	Title of Project	Duration	Funding Agency	Total Amount	Principal Investigator
1.	Rural Transformation and Challenges in Living in not so Dynamic States of India	24 Months	ICSSR	5 Lakhs	Prof. Nisha Srivastava

Funding received during the period:

S.No.	Agency	Purpose	Amount
1.	U.G.C. Sap III DRS III	Seminar	1.5 Lakhs
2.	Planning & Development Unit	Seminar	1.5 Lakhs

DEPARTMENT OF BIOCHEMISTRY

S. No.	Title of Project	Duration	Funding Agency	Total Amount	Principal Investigator
1.	"Isolation, purification and	3 years	UPCST-	Rs.10.44 Lacs	Prof. B. Sharma

UNIVERSITY OF ALLAHABAD

S. No.	Title of Project	Duration	Funding Agency	Total Amount	Principal Investigator
	characterization of some phytochemicals against HIV-1”		Lucknow		
2.	‘Anti aging strategies based on caloric restriction mimetics: Role of glycolytic & mTOR inhibitors, and sirtuin activators in an accelerated senescence model of rat’	3 years (2018-2021)	SERB DST New Delhi	Rs. 44.12 lakh	Prof. S.I. Rizvi

Funding received during the period

S. No.	Agency	Purpose	Amount
1.	DST FIST	Strengthening infrastructure	48 Lacs
2.	UGC SAP	Strengthening infrastructure	108 Lacs
3.	Department of Biotechnology, Ministry of Science and Technology, Govt of India	National Genomics Core Grant for setting up a National Facility at University of Allahabad	20 crore six lacs eighty thousand

DEPARTMENT OF BOTANY

S.N.	Title of Project	Duration	Funding Agency	Total Amount	Principal Investigator
1.	EMR2016/4745	March 2018 to March 2021	DST-SERB	Rs. 37,12,340.00	Prof. S.M. Prasad

Funding received during the period (amount/purpose/agency) to the Department

S. No.	Agency	Purpose	Amount
1.	DST FIST programme	Upgradation and advancement of departmental UG, PG courses and research work	Rs 95,000,00

DEPARTMENT OF CHEMISTRY

S.No.	Title of Project	Duration	Funding Agency	Total Amount	Principal Investigator
1.	Ionic Liquid in multicomponent catalysed coupling of electrophilic alkyne with isocyanides for development of biodynamically significant heterocycles	2017-2019 2 years	UP CST	10.53 Lakh	Prof. I.R. Siddiqui

DEPARTMENT OF DEFENCE AND STRATEGIC STUDIES

S. No.	Title of Project	Duration	Funding Agency	Total Amount	Principal Investigator
1.	The Role of Social Media in India’s Foreign Policy	Two Years (1917-19)	Indian Council For Social Science Research(ICSSR), New Delhi	Rs. 20,000,00	Prof. Vijay Khare, Prof. S. Bhadauria; Prof. Bharti Das etc.

Funding received during the Period:

S.No.	Agency	Purpose	Amount
1.	University Grants Commission Special Assistance Programme (SAP) DRS II	Books, Seminar and Research related activities	56 Lakh + 1 Project Fellow (Funds not transferred as yet)

DEPARTMENT OF EARTH & PLANETARY SCIENCES

S.No.	Title of Project	Duration	Funding Agency	Total Amount	Principal Investigator
1.	“Spatio-temporal evolution of the TTG gneisses in Bundelkhand craton, Central Indian Shield ”.	3 years	Ministry of Earth Sciences, Govt. of India	Rs. 72.66 lakhs	Prof. Jayanta Kumar Pati

S.No.	Title of Project	Duration	Funding Agency	Total Amount	Principal Investigator
2.	Dhala Structure, Shivpuri district, M.P., India-a Palaeoproterozoic Meteoritic Impact Structure	1 year	International Geological Congress, Ministry of Earth Sciences, GoI	Rs.3 lakhs	Prof. Jayanta Kumar Pati
3.	Estimation of seismic wave attenuation by coda wave analysis in Himalayan region, India.	3 years	UGC (Major)	Rs.13.89 lakhs	Dr. Priyamvada Singh
4.	Estimation of seismic wave attenuation by coda wave analysis.	3 years	SERB- DST	Rs.19.17 lakhs	Dr. Priyamvada Singh
5.	Fluid flow through fractures under high stress environment	2 years	UGC Start-up	Rs.10 lakhs	Dr. Prakash Kumar Singh
6.	Functional dynamics and slopes stability modelling by inculcating the role of Bedrock- Overburden Interface (BOI) geometry as domineering parameter.	2 years	UGC Start-up	Rs.10 lakhs	Dr. Ravindra Pratap Singh

Funding received during the period (amount/purpose/agency) to the Department

S. No.	Agency	Purpose	Amount
1.	Laboratory Grant	Consumable & laboratory	Rs. 1.75 Lakh

DEPARTMENT OF MATHEMATICS

Funding received during the period (amount/purpose/agency) to the Department

S.No.	Funding Agency	Purpose	Amount
1.	DST, New Delhi, India (FIST-2017)	Infrastructure (Equipment+Networking+Books)	Rs.30 Lakhs

DEPARTMENT OF ELECTRONICS AND COMMUNICATION

J.K. Institute of Applied Physics & Technology, University of Allahabad

S. No.	Title of Project	Duration	Funding Agency	Total Amount	Principal Investigator
1.	FIST Program-2017 to augment the post graduate teaching & research facilities in the Department.	2017-	DST, Govt. of India	Rs. 162 Lakhs	Prof. J. A. Ansari Prof. Rajeev Singh

DEPARTMENT OF PHYSICS

S. No.	Title of Project	Duration	Funding Agency	Total Amount (in Rs.)	Principal Investigator
1.	On line analysis of impurities quoted on optical windows and first wall of Aditya Tokamak using LIBS	2 years 02/04/2017 – 31/03/2019	BRNS (DAE)	11,60,300/-	Prof. A.K. Rai

Funding received during the period

S.No.	Agency	Purpose	Amount (in Rs.)
1.	Consumable of Laboratory grant	Consumable, spare parts and minor repairing	7.00 lakhs

DEPARTMENT OF ZOOLOGY

Funding received during the period

S. No.	Agency	Purpose	Amount
1.	Allahabad University Zoology Lab grant 2018-19	Chemicals/consumables	Rs 4,00,000=00 (Rs four lakhs only)
2.	Allahabad University Agricultural Zoology &	Equipments/consumables for	Rs 1.50 lakhs only

S. No.	Agency	Purpose	Amount
	Entomology Lab grant 2018-19	Ag.Zoology & Entomology	

CENTRE OF BIOTECHNOLOGY

S. No.	Title of Project	Duration	Funding Agency	Total Amount	Principal Investigator
1.	Development of Biogenic 3D nanoporous silica-based sensor for enhanced sensitivity against plant pathogenic fungi	3 Years	DRDO	34 lakh	Prof. Shanthi Sundaram
2.	"Impact of mass bathing event on the natural microbiota of the river Ganges; a concern to human health"	3 Years	DBT	125 Lakh	Prof. Shanthi Sundaram
3.	Synthesis, characterization and evaluation of ciprofloxacin and gentamicin loaded solid lipid – chitosan composite Nanoparticles for the treatment of mastitis in dairy animal	3 Years	DBT, New Delhi	132.5	Dr. Awadh Bihari Yadav
4.	Synthesis and characterization of siRNA loaded ligand bearing PLGA nanoparticles for targeted delivery to the lung cancer	3 Years	DST Nanomission	54.74	Dr. Awadh Bihari Yadav
5.	Nanobiotechnology based Therapy & Bio-Entrepreneurship	3 Years	MHRD	100 lakh	Dr Awadh Bihari Yadav
6.	Development of the SPLUNC1 protein loaded composite nanoparticles based targeted therapy for the treatments of lung inflammation	3 Years	SERB	43 lakh	Dr. Awadh Bihari Yadav
7.	Construction of Cold Inducible Expression System	3-years 2017-2020	DBT, New Delhi	36.103 lakh	Prof. M.P. Singh (Co-PI)

Funding received during the period

S. No.	Agency	Purpose	Amount
1.	DBT	Scholarship, chemicals, maintenance and contingency	18.23 lakh
2.	UGC	lab grant	2.5 lakh

CENTRE OF BIOINFORMATICS

S.No.	Title of Project	Duration	Funding Agency	Total Amount	Principal Investigator
1.	Understanding and influencing pluripotency& reprogramming: a network biology approach	3 year	DBT	22.10	Dr. AnupSom

K. BANERJEE CENTRE OF ATMOSPHERIC AND OCEAN STUDIES

S.No.	Title of Project	Duration	Funding Agency	Total Amount	Principal Investigator
1.	Understanding Teleconnections between Southern Hemisphere Extra-Tropical Temperatures and Indian Summer Monsoon	2017-2020	DST	Rs. 61,65,060/-	Prof. Suneet Dwivedi
2.	Characterization of land-atmosphere coupling, land surface variables and fluxes over the Indian region using observations and land surface and coupled model simulations	2017-2019	UGC	Rs. 10,00,000/-	Dr. Subhadeep Halder
3.	Impact of surface and subsurface Variability of Southwest tropical Indian Ocean in the variability of the Indian Ocean	2016-2019	DST	Rs. 22,73,200/-	Dr. Shailendra Rai

S.No.	Title of Project	Duration	Funding Agency	Total Amount	Principal Investigator
4.	DST_FIST	2018-2023	DST	Rs. 1,37,000/-	Coordinator, KBCAOS

Funding received during the period

S. No.	Agency	Purpose	Amount
1.	DST-FIST	Equipment/Infrastructure upgradation	Rs. 1.37 Crores
2.	University of Allahabad	Equipment/Lab Grant	Rs. 1.00 lakh

CENTRE OF MATERIAL SCIENCES

S. No.	Title of Project	Duration	Funding Agency	Total Amount	Principal Investigator
1.	To determine mixed valence state of Mn, Fe and Ru in CaMnFeO and LiMnRuO	Three year [February 2017 onwards]	UGC-DAE-CSR, Indore Centre	Rs 7,39,800.00	Dr. Brajendra Singh

Funding received during the period

S.No.	Agency	Purpose	Amount
1.	DST-FIST (Continued Programme)	Equipmentsetc	Rs. 1,15,000,00
2.	Department of Science & Technology (DST)	For 25th National Conference on Liquid Crystals	Rs. 2,00,000
3.	Department of Bio Technology (DBT)	For 25th National Conference on Liquid Crystals	Rs. 1,00,000
4.	Board of Research in Nuclear Science (BRNS)	For 25th National Conference on Liquid Crystals	Rs. 50,000
5.	Council of Scientific and Industrial Research (CSIR)	For 25th National Conference on Liquid Crystals	Rs. 50,000
6.	Lab Grant	From UGC/University	Rs. 1,00,000

CENTRE OF SCIENCE AND SOCIETY (Rural Technology and Development)

S. No.	Name of Project	Duration	Funding Agency	Total Amount	Principal coordinator	Annual Grants (2018-19)
1.	Rural Innovation Centre	03 years	MHRD	50 Lakhs	Prof. Anupam Dikshit	Rs. 10,85,168.00
2.	Post Project Evaluation Study of 104 Gram Panchayat of Saansad Adarsh Gram Yojana (SAGY) of 1st phase of U.P.	06 Months	Ministry of Rural Development, New Delhi	46.0 Lakhs	Prof. Anupam Dikshit	Rs. 12,42,000.00 Lakhs

CENTRE OF BEHAVIORAL AND COGNITIVE SCIENCES

S.No.	Title of Project	Duration	Funding Agency	Total Amount	Principal Investigator
1.	The neural mechanisms of decision making for co-ordinated eye-hand movements.	5 Yrs.	Wellcome Trust DBT India Alliance	INR 22501600.00	Dr. Supriya Ray
2.	Religion and Social Decision Making	3 Yrs.	Arizona State University, USA	US\$ 24360.00	Prof. Narayanan Srinivasan
3.	Influence of attention on control of eye movement	3 Yrs.	DST, Government of India	INR 48.582 lakh	Dr. Supriya Ray
4.	Extensive Cognitive Neuroimaging	5 Yrs	DST, Government of India	INR 19 crore	Prof. Narayanan Srinivasan

S.No.	Title of Project	Duration	Funding Agency	Total Amount	Principal Investigator
5.	Dynamic adjustments in control EEG characterization of anxiety and its effect on cognitive control	3 Yrs.	DST, Government of India	INR 32 lakh	Prof. Bhoomika R. Kar
6.	Age related anticipation and language processing	3 years	DST, Government of India	INR 14.94 lakh	Dr. Niharika Singh
7.	Testing the explanatory limits of value representations		DST	INR 2.86 lakhs	Prof. N Srinivasan (Co-PI)

Funding received during the period (amount/purpose/agency) to the

S. No.	Agency	Purpose	Amount
1.	DST	Research project	Rs. 2. 86 lakhs
2.	UGC (CPEPA)	Remaining grant under the CPEPA scheme	1.46 Crore
3.	DST	Neuro Imaging Facility	1.35 Crore
4.	DST FIST grant	Infrastructure and training	1.30 Crore

CENTRE OF FOOD TECHNOLOGY

S. No	Title of Project	Duration	Funding Agency	Total Amount	Principal Investigator
1.	Effect of minimal and thermal processing on antioxidant activity and in vitro anticancer activity of guava cultivars	2016-2018	DST-SERB	11,00,000/-	Dr Devinder Kaur

NATIONAL CENTRE OF EXPERIMENTAL MINERALOGY AND PETROLOGY

S. N.	Title of Project	Duration	Funding Agency	Total Amount	Principal Investigator
1.	Spatio-temporal evolution of the TTG gneisses in Bundelkhand craton, Central Indian Shield.	3 years	Ministry of Earth Sciences, Govt. of India	Rs. 72.66 lakhs	Prof. J.K. Pati
2.	Dhala Structure, Shivpuri district, M.P., India-a Palaeoproterozoic Meteoritic Impact Structure.	1 year	International Geological Congress, Ministry of Earth Sciences, Government of India, New Delhi, India	Rs.3 lakhs	Prof. J.K. Pati
3.	Development of nano-composite Polymer electrolyte for the application of renewable energy source.	3 years	Women Scientist Scheme (WOS), Department of Science and Technology, Government of India	Rs.15 lakhs	Ms. Nidhi Asthana

GOVIND BALLABH PANT SOCIAL SCIENCE INSTITUTE:

S. No.	Title of Project	Duration	Funding Agency	Total Amount	Principal Investigator
1.	Social Impact Evaluation of Surrounding Village of NTPC, Tanda	10.01.2018 to 09.07.2018	NTPC, Tanda	6,38,400.00	B. Majumder

S. No.	Title of Project	Duration	Funding Agency	Total Amount	Principal Investigator
2.	Care of elderly women in India with special reference to the women living in shelter home in Uttar Pradesh	01.03.2018 to 01.02.2019	NCW- New Delhi	6,30,000.00	B. Majumder
3.	Integration of Indigenous Knowledge for Sustainable Livelihood Support from Forests in the Himalayan Forest Belts	01.04.2017 to 31.03.2019	ICSSR & JSPS (Indo-Japan)	10,58,875.00	B. Majumder
4.	Need Assessment Study of Households Displaced by Land Acquisition for MUNPL Allahabad	10.08.2018 to 09.11.2018	Meja Urja Nigam Limited (MUNPL)	1,99,500.00	B.Majumder
5.	Rural Mind: Culture crowd	01.09.2018 to 31.03.2019	Kumbh Mela Police-2019	5,00,000.00	Archana Singh
6.	Social Impact Assessment Study for the Protection of Aquatic Flora and Fauna	01.10.2018 to 31.12.2018	Department of Forest, Lucknow, Uttar Pradesh	6,43,500.00	Badri Narayan Tiwari and Archana Singh
7.	Identification of Child Labour in District-Rampur	10.01.2019 to 09.03.2019	NCLP-Rampur	3,99,500.00	Sunit Singh
8.	Concurrent Evaluation of the Implementation of National Food Security Act in UP and Uttarakhand	01.07.2018 to 31.03.2020	Ministry of Consumer Affairs, Food and Public Distribution, New Delhi	1,68,750.00	S.K. Pant
9.	Rural Station Project 2018	03.10.2018 to 02.09.2019	Unnat Bharat Mission	1,07,500.00	Archana Singh

RESEARCH PROJECTS RUNNING AT CONSTITUENT COLLEGES

C.M.P. DEGREE COLLEGE

S. No.	Title of Project	Duration	Funding Agency	Total Amount	Principal Investigator
1.	Management of chromium (V) toxicity in some vegetable crops (tomato, brinjal and pea) through sulphur nutrition: Physiological and biochemical approaches	ongoing	DBT, New Delhi	35,36,229=00	Dr. Vijay Pratap Singh Assistant Professor, Botany Department, CMP College
2.	Investigation on nitric oxide and hydrogen sulphide crosstalk and acquisition of arsenate tolerance in rice seedling.		SERB, DST, New Delhi	34,45,400=00	Dr. Vijay Pratap Singh Assistant Professor, Botany Department, CMP College
3.	Synthesis of potential antifungal heterocyclic compounds under green reaction conditions.	2 Years	U.G.C. New Delhi	10 lakh	Dr. Pravin K. Singh, Assistant Professor, Chemistry Department, CMP College
4.	Photocatalyzed synthesis of novel heterocyclic compounds as potential antiviral agents	2 Years	U.G.C. New Delhi	10 lakh	Dr. Vishal Srivastava, Assistant Professor, Chemistry Department, CMP College
5.	Reactivity and catalytic aspects of transition metal complexes with redox active ligand	2 Years	U.G.C. New Delhi	10 lakh	Dr. Akram Ali, Assistant. Professor,, Chemistry Department, CMP College
6.	Visible Light Driven Synthesis- Applications of metal-free, ionic liquid based photocatalytic systems for synthesis of clinically potent anti-tumor heterocycles	2 Years	U.G.C. New Delhi	10 lakh	Dr. Arjita Srivastava Assistant Professor, Chemistry Department, CMP College
7.	Modification in Physico chemical ingredients for successful drug delivery through co- crystallization, salt formation and dimerization: Perspective for solubility, stability and bioavailability	2 Years	U.G.C. New Delhi	10 lakh	Dr. Ranjeet Kumar Assistant Professor, Chemistry Department, CMP College
8.	Ecology of the Benthic Macro invertebrate and diatom communities in Rivers Ken & Betwa with reference to their potential for Biomonitoring	2 Years	U.G.C. New Delhi	10 lakh	Dr. Jyoti Verma Assistant Professor, Zoology Department, CMP College
9.	The possible role of Endothelial Nitric Oxide Synthase (eNOS) in Nanoparticle-mediated toxicity in fish	2 Years	U.G.C. New Delhi	10 lakh	Dr. Vinay Kumar Singh Assistant Professor, Zoology Department, CMP College
10.	Role of NADPH oxidase (NOX) mediated signaling in inflammatory pain	2 Years	U.G.C. New Delhi	10 lakh	Dr. Ajeet Kumar Singh Assistant Professor, Zoology Department, CMP College
11.	Study of Environmental samples using LIBS and its Artificial Neural Network Analysis	2 Years	U.G.C. New Delhi	10 lakh	Dr. Rohit Kumar Assistant Professor, Physics Department, CMP College

UNIVERSITY OF ALLAHABAD

S. No.	Title of Project	Duration	Funding Agency	Total Amount	Principal Investigator
12.	Crystal - Crystal transition and separation of binary mixtures: A density functional approach	2 Years	U.G.C. New Delhi	10 lakh	Dr. Atul S.Bhardwaj Assistant Professor, Physics Department, CMP College
13.	Synthesis of large area inorganic-organic materials for the development of thermoelectric generators	2 Years	U.G.C. New Delhi	10 lakh	Dr. Hari Pratap Bhasker Assistant Professor, Physics Department, CMP College
14.	Screening, identification and in silico analysis of mineral phosphate solubilizing bacteria	2 Years	U.G.C. New Delhi	10 lakh	Dr. CharuTripathi Assistant Professor, Zoology Department, CMP College
15.	Promotion of Urdu Language	ongoing	MHRD Ministry	1,05000=00	Urdu Department

EWING CHRISTIAN COLLEGE

S.No.	Title of Project	Duration	Funding Agency	Total Amount	Principal Investigator
1.	Development and Characterization of nanosuspension of Lycopene for efficient hepatoprotective activity	2 Years	UGC	2,85,000/=	Dr. S. Sundaram Sanjay
2.	Removal of heavy metals from aqueous solutions using modified low cost agricultural waste	2 Years	UGC	1,60,000/=	Dr. Justin Masih
3.	Solution and Microwave assisted synthesis of graft copolymers based on Ocimumbasilicum L. starch and polyacrylamide: Water treatment and <i>in-vitro</i> drug release study	2 Years	UGC	10,00,000/=	Dr. Kranthikumar Tungala
4.	Some Potential Anti-Cancer Drugs: Synthesis, Characterization and Anticancer activity of metal Complexes with Indole-Based Analogues in Conjunction with auxiliary phosphine ligands	2 Years	UGC	10,00,000/=	Dr. Ebenezer Samuel

ISWAR SARAN DEGREE COLLEGE

S.No.	Title of Project	Duration	Funding Agency	Total Amount	Principal Investigator
1.	Archaeological Survey Work in Allahabad (ASI, New Delhi)	One Year	Applied for	2,50,000.00 (Yet to receive)	Dr A S Singh
2.	<i>Ghazipur mein 1857 : Pratirodh ka lok swaroop va swatantra ke Swar</i>	2 Years	ICHR, New Delhi	3,50,000.00	Dr Narendra Kumar Singh

SHYAMA PRASAD MUKHERJEE GOVT. DEGREE COLLEGE

S. No.	Title of Project	Funding Agency	Total Amount	Principal Investigator
1.	<u>Start up Grants</u> Sodic Soil Reclamation : Understanding the Complex Relationship between Soil Carbon and Nitrogen turnover for cost effective monitoring solutions.	UGC , New Delhi	Rs 10.00 Lakh	Dr Pratap Srivastava, Assistant Professor, Botany

REPORTS OF THE CONSTITUENT COLLEGES / INSTITUTES OF UNIVERSITY OF ALLAHABAD

ALLAHABAD DEGREE COLLEGE

Introduction

Allahabad Degree College, a Constituent P.G. College of University of Allahabad, established in 1956, aims to fulfill the needs of the society in terms of quest for knowledge. It provides equal opportunity to all students, including those belonging to socially and economically weaker sections of the society to study multiple disciplines, including social sciences, humanities, commerce, law, basic and applied sciences, with the aid of best practices, qualified teachers, teaching aids and infrastructure, under the academic leadership of the University of Allahabad. The College provides quality education to all students coming from rural as well as urban background.

Programmes of Study:

S.No.	Programme of Study	Duration	No. of Seats	Specialization(s)
1.	M. A./M. Sc.	2 years	825	Ancient History, Defence & Strategic Studies, Economics, Education, English, Geography, Hindi, History, Music Vocal, Music Sitar, Music Tabla, Painting, Philosophy, Political Science, Psychology, Sanskrit, Urdu, Commerce, Law, Physics, Mathematics
2.	B. A./B. Sc./ B.Com/LL.B	3 years	3357	---

Details of Students, Year wise and Reservation wise (2018-2019):

Course	Gen			OBC			SC			ST			TOTAL		
	Male	Female	Total	Male	Female	Total	Male	Female	Total	Male	Female	Total	Male	Female	Total
PG	218	183	401	132	102	234	34	36	70	00	01	01	384	322	706
UG	1982	506	2488	1312	388	1700	377	166	543	02	00	02	3673	1060	4733
Total	2200	689	2889	1444	490	1934	411	202	613	02	01	03	4057	1382	5439

Awards/Honours/Fellowship received:

S. No.	Name of Faculty Member/ Student who received award	Name of the award	Organization conferring award
1.	Dr. Rajendra Kumar Tripathi	1. Iswari Prasad Sarjana Award 2. Special Award	1. U.P. Hindi Sansthaan Lucknow. 2. U.P. Sanskrit Sansthaan Lucknow.

Journals published by the College:

S. No.	Title	Nature	Annual/bi-annual /quarterly	ISSN
1.	APRAJITA	NATIONAL	ANNUAL	2349-0993

Outreach activities:

S.N.	Name of Faculty Member/ Student/ Researcher	Title of the paper presented	Title of Conference/ Seminar etc	Duration of the conference/ assignment	Organized by
1.	Dr. Rajendra Kumar Tripathi	Swatantrottar Sanskrit Kavyanushilnam	17 th World Sanskrit	09-13 July 2018	University of British Columbia, Vancouver, Canada

ARYA KANYA DEGREE COLLEGE

Introduction:

Introduction:

The College, affiliated to the Allahabad University was founded on the principles of Maharshi Dayanand Saraswati and established in the year 1975, the International Year of Women. It was declared a Constituent College of Allahabad University on 14th July, 2005 the year the University achieved Central status.

The goals and objectives of the College which is situated in the thickly populated area of the city are focused towards education and empowerment of women specially from the backward areas. Our endeavour has been to promote independent thinking among young girls and make them responsible citizens so that they play the role of an anchor in their own families.

Thrust Areas:

- The College organizes lectures by outstanding academicians.
- Career counseling is given to the students from time to time by career experts.
- We encourage sports and games both indoor and outdoor because physical exercise and training provide good health which is necessary for physical health and intellectual pursuits.
- Vocational and job oriented courses enables the students to gain specific skills and recognition.
- Participation of students in various competitions organized by the University and other degree Colleges.
- The College also organizes Seminars and Training Programmes.

Programmes of Study:

S. No.	Programme of Study	Duration	No. of Seats	Specialization(s)
1.	M. A. (Self Financing)	2 years (4 Semester)	350	Sanskrit, Sociology, Music Vocal, Political Science, Hindi, English, Education, Economics -
2.	B. A.	3 years	1120	Not Required
3.	B.Com. (Self Financing)	3 years	60	

Details of Students, Year wise and Reservation wise (2018-2019):

Course	Gen			OBC			SC			ST			TOTAL		
	Male	Female	Total	Male	Female	Total	Male	Female	Total	Male	Female	Total	Male	Female	Total
PG	-	41	41	-	40	40	-	08	08	-	-	-	-	89	89
UG – B.A.	-	234	234	-	241	241	-	74	74	-	-	-	-	549	549
UG - B.Com	-	33	33	-	16	16	-	02	02	-	-	-	-	51	51
Total	-	308	308	-	297	297	-	84	84	-	-	-	-	689	689

Training/orientation/refresher courses/special lectures conducted by the College:

S. No.	Name of the course	Duration and dates	Funding/sponsor	Speakers
1.	Training Programme on Rights of Child	One day 29.04.2018	National Human Rights Commission, New Delhi	Justice Ashok Gupta, High Court, Allahabad Sri Ramit Sharma, IG Zone, Allahabad Dr. Sanjay Dubey, NHRC, New Delhi Justice Suneet Kumar, Judge High Court Shri N.C.Rajvanshi, Senior Advocate, High Court Prof. Manmohan Krishna, Economics

S. No.	Name of the course	Duration and dates	Funding/sponsor	Speakers
				Department, UoA Sri Suhas L.Y. DM, Allahabad Prof. H.K.Sharma, Political Science Department, Allahabad University
2.	One Day Training Programme on Human Rights in the Present Scenario	One day 10.03.2019	National Human Rights Commission, New Delhi	Justice Vijay Laxmi, High Court, Allahabad Prof. H.K.Sharma, Political Science Department, Allahabad University Prof. R.K. Chaubey, Dean, Faculty of Law, Allahabad University Sri Brijesh Srivastava, SP City, Prayagraj Sri Ravi Kiran Jain, Advocate, High Court Acharya Maha Mandaleshwar Shri Shri Laxmi Narayan Tripathi

Funding received during the period (amount/purpose/agency) to the College

S.No.	Agency	Purpose	Amount
1.	National Human Rights Commission, New Delhi	Training programme	Rs. 45837/-
2.	National Human Rights Commission, New Delhi	Training programme	Rs. 25000/-
3.	Allahabad University annual grant (Non-Salary Non-Plan)	Infrastructure/upgradation/ reimbursement	Rs. 15.50 Lac

Research Projects:

S.No.	Title of Project	Duration	Funding Agency	Total Amount	Principal Investigator
1.	Concept and Relevance of Peace Education in Indian Philosophy	2 Yrs	Indian Council of Philosophical Research (Government of India, Ministry of HRD)	3.50 Lacs	Dr. Shruti Anand

Proposed Courses

S.No.	Name of Programme	Nature	Duration	Proposed or In process	Intake of Students
1.	B.Ed.	Degree	2 Years	In Process	100
2.	5 year Law Course	Degree	5 Years	In Process	



Mr. Arunesh Jaiswal, S.P.City Mr. Brijesh Srivastava, Chairperson Mr. Pankaj Jaiwal and Prof. R.K.Chaubey, Dean Law, Faculty of Law, UoA in training programme on human rights



Member in counseling cell, Allahabad University counseling the College Student

C.M.P. DEGREE COLLEGE

Introduction:

The college was established in the year 1950. The College is under the governance of 'Kayastha Pathshala' which is the Asia's biggest trust. From session 2016-17 post-graduation i.e. **M.Com; LL.M; M.Sc.** in Botany, Zoology, Chemistry, Mathematics, Physics; **M.A.** in Anc. History, Med. History, Economics, Education, English, Geography, Hindi, Philosophy, Pol. Science, Sanskrit, Sociology, Psychology running smoothly. 5 year B.A.LL.B. course has started from the session 2018-19 successfully. Recommendations for Ph.D./research is granted by the university in various subjects.

The mission of the college is to provide all-round intellectual, physical, moral and spiritual development of students. It promotes commitment among student for social upliftment and human values.

Thrust Areas:

- Enhancing and up gradation of infrastructure for College especially for Post Graduate courses and Research.
- Start Professional courses to uplift and improve the skill of students for the employability.
- Starting of Research Facilities.

Programmes of Study:

S. No.	Programme of Study	Duration	No. of Seats	Specialization(s)
1.	M. A./M. Sc./ M.Com./LL.M.	2 years	1050	M.A. – Anc. History, Medieval History, Philosophy, Hindi, Geography, English, Political Science, Sanskrit, Education, Economics, Sociology, Psychology, Music, Urdu M.Sc. – Zoology, Botany, Chemistry, Mathematics, Physics M.Com., LL.M.
2.	B. A./B. Sc. /B.Com./LL.B.	3 years	4582	Not Required
3.	Diploma Courses	DCA BCA Diploma in Theatre	40 30 30	
4.	B.A.LL.B.	5 years	120	

Details of Students, Year wise and Reservation wise (2018-2019):

Course	Gen			OBC			SC			ST			TOTAL		
	Male	Female	Total	Male	Female	Total	Male	Female	Total	Male	Female	Total	Male	Female	Total
PG	317	262	579	269	195	464	93	87	180	02	01	03	681	545	1226
UG	259	828	341	2728	886	3614	883	480	1363	12	03	15	6214	2197	8411
Diploma	04	05	09	04	01	05	03	-	-	-	-	-	11	06	17
BCA	03	01	04	09	-	09	-	-	-	-	-	-	12	01	13
B.A.LL.B.	25	25	50	29	12	41	09	07	16	-	-	-	63	44	107
Total															9774

Seminars/Workshops/Conferences conducted by the Department College:

S. No.	Name of the Seminar/ workshop/conference	National / International	Duration and dates	Funding/sponsor Agenc(y/ies)	No. of Participants	No. of Papers presented
1.	workshop on "Gene Cloning and its expression to produce	National	3 days 13th - 15 th September	CytoGene Lucknow Conducted by Department of Botany,	80 delegates	

S. No.	Name of the Seminar/workshop/conference	National / International	Duration and dates	Funding/sponsor Agenc(y/ies)	No. of Participants	No. of Papers presented
	Genetically Modified Organisms”		2018	CMP College		
2.	Seminar on “Present scenario of Environmental Challenges & Issues”	National	One day 16 th Dec. 2018	CSCMPC, Chemistry Department, CMP College	300	30
3.	Workshop on “Psychological Wellbeing”	National	One day 20 th Nov. 2018.	Department of Chemistry CMP College in collaboration with DMHP, Govt. of India.	200	12
4.	Seminar for UG students on “Chemistry in Daily Life.”	Departmental	One day 14 th Sept.2018.	Department of Chemistry	170	6
5.	Seminar was organized for UG & PG Students	Departmental	One day 6 th Sept. 2018	Career and Counselling Cell, CMP in collaboration with Employment Exchange, AU and Model Career Center, AU.	210	4
6.	Seminar on “Chayavaad ke Sau Varsh”	National	One day 30 th Oct. 2018	Conducted by Hindi Department, CMP	-	
7.	Training Workshop on “Use of Computer Software in Behavioral Experiments”	National		Conducted by Psychology Department CMP	-	
8.	Human Rights Law : Prospects and challenges	National Seminar	One day 22 Feb 2019	Conducted by Law Department CMP	300	60

Funding received during the period (amount/purpose/agency) to the Department/Centre

S.No.	Agency	Purpose	Amount
1.	UGC through Allahabad University	Non Plan-Non Salary	70 Lakhs
2.	UGC through Allahabad University, OBC Grant	for Lab equipment	26,53,760=00

Other publications by the Department/Centre:

S. No.	Title	Type	Author(s)	Publication
1.	“CHEM-WORLD” Volume III	Departmental bulletin	Editor: Dr.Babita Agrawal	Deptt. of Chemistry, CMP PG College
2.	“ZOO LIFE” Volume- V December 2018	Departmental Magazine	Editorial Board	Deptt. of Zoology, CMP PG College

Proposed Courses

S.No.	Name of Programme	Nature	Proposed or In process	Intake of Students
1.	Ph.D. in Arts Faculty – Hindi, English, Sanskrit, Geography, Education, Anc.History, Pol.Science	Degree	Sanctioned	74
2.	Ph.D. in Science faculty- Botany, Chemistry, Zoology	Degree	Sanctioned	100
3.	Ph. D. in Commerce	Degree	Sanctioned	12
4.	Ph.D. in Law	Degree	Sanctioned	18



Release of book "Advances in Chemical and Applied Sciences Vol I" published by Chemical Society CMP College on Founders' Day celebrations 5th March 2019

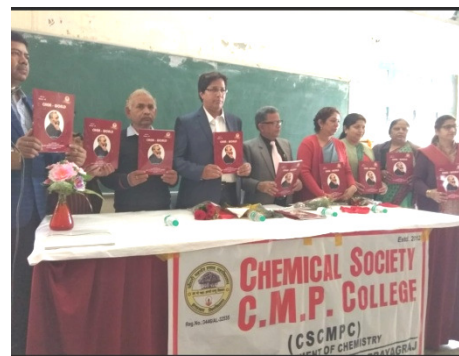

The annual departmental bulletin "Chem-World" Vol-III of Chemistry Department, CMP was released on 3rd March 2019



One day National Seminar was organized by Chemistry Department, CMP on "Present scenario of Environmental Challenges & Issues" on 16th Dec. 2018 in CMP Degree College



One day National Seminar on "Psychological Wellbeing" was organized by Department of Chemistry in collaboration with DMHP, Govt. of India



Dr. Archana Pandey receiving Award of Excellence



Inaugural Function of 5 year B.A.LL.B.

EWING CHRISTIAN COLLEGE

Introduction

Ewing Christian College was founded in the year 1902 by Dr. Arthur H. Ewing, a missionary who was its first Principal. The College Campus is located on the Northern Bank of Jamuna River about 3 Km. away from the Sangam and about 4 Km. from the Railway Station. The College is a Christian Minority Educational Institution and controlled by the Ewing Christian College Society, consisting of the Bishop of Lucknow Diocese of the Church of North India and other Indian Christian representatives.

Ewing Christian College as an Autonomous Associated College since 1994, is now an autonomous constituent college of the University of Allahabad.

Programmes of Study:

S. No.	Programme of Study	Duration	No. of Seats	Specialization(s)
1.	M.A.	2 Years	50 in each	Ancient History, Economics, Education, English, Hindi, Philosophy, Political Science
2.	M.A.	2 Years	30 in each	Psychology, Geography
3.	M.A./M. Sc.	2 Years	50 in each	Mathematics
4.	M. Sc.	2 Years	30 in each	Botany, Chemistry, Zoology, Statistics, Physics
5.	B. A./B. Sc.	3 Years		--
6.	B. Com. (Self-financed)	3 Years	150	--
7.	B.C.A. (Self-financed)	3 Years	60	--
8.	PG Diploma in Computer Application	2 Years	50	--
9.	PG Diploma in Journalism & Mass Communication	2 Years	20	--
10.	Diploma in Mass Communication	1 Year	20	--
11.	Diploma in Laboratory Technology	2 Years	42	--

Details of Students, Year wise and Reservation wise (2018-2019):

Course	Gen			OBC			SC			ST			PwD			TOTAL		
	Male	Female	Total	Male	Female	Total	Male	Female	Total	Male	Female	Total	Male	Female	Total	Male	Female	Total
Ph.D.																		
PG	114	194	308	68	113	181	4	9	13	1	0	1	0	0	0	187	316	503
UG	1524	1092	2616	924	595	1519	111	51	162	5	2	7	11	13	24	2575	1573	4328
PGDCA	8	17	25	7	2	9	0	1	1	0	0	0	0	0	0	15	20	35
PGDJMC	4	2	6	5	2	7	0	1	1	0	0	0	0	0	0	09	05	14
DMC	4	1	5	2	1	3	0	1	1	0	0	0	0	0	0	06	03	09
Total																		

Seminars/Workshops/Conferences conducted by the Department/Centre:

S. No.	Name of the Seminar/workshop/conference	National / International	Duration and dates	Funding/sponsor Agency/(ies)	No. of Participants	No. of Papers presented
DEPARTMENT OF CHEMISTRY						
4.	Chemistry on Public Health	District	One day 1 st March, 2019	Self	120	20

UNIVERSITY OF ALLAHABAD

S. No.	Name of the Seminar/workshop/conference	National / International	Duration and dates	Funding/sponsor Agency/(ies)	No. of Participants	No. of Papers presented
DEPARTMENT OF BOTANY						
5.	Seminar on "Biodiversity & Its Conservation"	National	One day	College	66	18
DEPARTMENT OF PSYCHOLOGY						
6.	Mental Health: Skills For Sustainable Life	National	One day	National Health Mission	100	07
ELECTRONICS						
7.	Workshop on "Mobile Controlled Robotics"	National	One day	Self-financed	66	None
DEPARTMENT OF COMMERCE (B. Com.)						
8.	Opportunities for Commerce Student in New GST Regime	National	One Day 07/09/2018	Self-Financed	150	None
B.C.A.						
9.	Skill Workshop in Java	-	3 Days 15 – 17/09/2018	-	65	None

Training/orientation/refresher courses/special lectures conducted by the College:

S. No.	Name of the course	Duration and dates	Funding/sponsor	Speakers
1.	Chemistry Lecture Series-I (held on National Science Day) "AIDS awareness and Scientific Implication"	2 hours (28 th February, 2019)	Self	Prof. (Dr.) Ramendra Singh, Examination Controller and Professor, Department of Chemistry, University of Allahabad
2.	Chemistry Lecture Series-II "Modern Periodic Table and its service to mankind"	2 hours (29 th March, 2019)	Self	Prof. (Dr.) Ashok Mahan, Former Head, Department of Chemistry, University of Allahabad
DEPARTMENT OF BOTANY				
3.	Wiiinfield Dudgeon Memorial Lecture	One day 29.03.19	None	Dr. AjaiShanker IFS
4.	PanchananMaheshwari Memorial Lecture	One day 29.03.19	None	Prof. (Dr.) Rita Singh, IPU, New Delhi
DEPARTMENT OF MATHEMATICS				
5.	Galois Theory and it's Applications	2 hours 27.03.2019	College	Prof. RamjiLal Adjunct Faculty, Harish Chandra Research Institute, Prayagraj
6.	S. Pathak Memorial Lectre: "Beauty of Mathematics"	2 hours 31.08.2018	College	Prof. Kuldeep Kumar, Bond University, Australia
DEPARTMENT OF GEOGRAPHY				
7.	Lecture Series in Professionalism in Geography	07 & 13.03.2019	-	Prof. A.R. Siddique & Prof. H.N. Mishra
B.C.A.				
8.	5 Day Specialized Training Workshop on HTML, CSS, PHP and MySQL	5 Days 21- 26.02.2019	-	Trainers from AVD Technologies
9.	Parivrtaan on Communication interview	1 Day 13.10.18	-	Mr. Subhas Srivastava

Research Projects:

S.No.	Title of Project	Duration	Funding Agency	Total Amount	Principal Investigator
-------	------------------	----------	----------------	--------------	------------------------

S.No.	Title of Project	Duration	Funding Agency	Total Amount	Principal Investigator
1.	Development and Characterization of nanosuspension of Lycopene for efficient hepatoprotective activity	2 Years	UGC	2,85,000/=	Dr. S. Sundaram Sanjay
2.	Removal of heavy metals from aqueous solutions using modified low cost agricultural waste	2 Years	UGC	1,60,000/=	Dr. Justin Masih
3.	Solution and Microwave assisted synthesis of graft copolymers based on Ocimumbasilicum L. starch and polyacrylamide: Water treatment and <i>in-vitro</i> drug release study	2 Years	UGC	10,00,000/=	Dr. Kranthikumar Tungala
4.	Some Potential Anti-Cancer Drugs: Synthesis, Characterization and Anticancer activity of metal Complexes with Indole-Based Analogues in Conjunction with auxiliary phosphine ligands	2 Years	UGC	10,00,000/=	Dr. Ebenezer Samuel

Proposed Projects/SAP Grants etc.

S. No.	Type of Project/grant	Title/Name	Duration	Proposed amount	Proposed or In process
1.	Major (Department of Psychology)	Experiments in mind operation with face architecture for prediction of psyche	3 Years	55,81,902/-	In Process

HAMIDIA GIRLS' DEGREE COLLEGE

Introduction :

Hamidia Girls' Degree College is a Constituent Minority PG College of the University of Allahabad functioning under the aegis of **The Association for the Education of Muslim Women at Allahabad**. It caters to the needs of modern higher education of girls and women and has maintained its accessibility to all sections of the society, especially Muslim girls. The College is a unique centre of quality modern higher education and vocational skills. Presently approximate 1500 girl students are enrolled in the College in three faculties and PG Courses.

HIGHLIGHTS

- Hamidia Girls' Degree College was given affiliation by the University of Allahabad in 1975. It started with six subjects in Bachelor of Arts. Then it added eight subjects. Taking forward the vision of its founder, Begum Khursheed Khawaja, and to fulfill the mission more faculties have been added – Faculty of Commerce where B. Com is functional and Faculty of Vocations where B. Voc in three trades - Journalism & Mass Com., Fashion Design and Software Technology is functional. PG classes have begun in four subjects – English, Urdu, Sociology & Medieval History as granted by the University of Allahabad in 2016. Now Research Degree Programme (Ph.D.) in Urdu sanctioned by the University of Allahabad will start from 2019-20.

Thrust Areas:

- Equity and wide access.
- Employment of girls through education and skills.
- Adding more vocational, job oriented course to churn out employable graduates.
- Development of Skills.
- Maintaining quality benchmarks in conventional subjects as well as vocational subjects.
- Facilitating employability of young girls so that they may become self reliant.
- Lowest fee structure as the College caters to the underprivileged sections of society.
- Maintaining blend of traditions and modernity.

Programmes of Study

S.No.	Programme of Study	Duration	No. of Seats	Specialization(s)
1.	M. A.	2 years	200	English, Urdu, Sociology & Med. History
2.	B. A.	3 years	710	--
3.	B.Com.	3 years	75	
4.	B.Voc.in three trades- <ul style="list-style-type: none"> • Journalism & Mass Communication • Fashion Design • Software Technology 	3 years	50 50 50	--
5.	Diploma Course <ul style="list-style-type: none"> • Urdu Kitabat 	2 Years	20	--

Details of Students, Year wise and Reservation wise (2018-2019) :

Course	Gen			OBC			SC			ST			PWD			TOTAL		
	Male	Female	Total	Male	Female	Total	Male	Female	Total	Male	Female	Total	Male	Female	Total	Male	Female	Total
PG		99	99		120	120		02	02								221	221
UG		402	402		674	674		05	05		11	11					1092	1092
Diploma		58	58		17	17											75	75
Total		559	559		811	811		07	07		11	11					1388	1388

Seminars/Workshops/Conferences conducted by the College:

S. No.	Name of the Seminar/ workshop / conference	Duration and dates	Funding /sponsor Agenc (y/ies)	No. of Participants	No. of Papers presented
1.	WORKSHOPS Career Counselling Cell conducted one-day Workshop on Career Counseling for Students -	1 Day 22.11.2018	HGDC	90	<ul style="list-style-type: none"> Mr. A.K. Bharti, Deputy Chief, UEIGB, UoA, Prayagraj. Mr. R. S. Bharti, Deputy Director, Kanpur / Allahabad Region. Mr. Sugreev Singh, Librarian, Model Career Centre, UoA, Prayagraj. Mr. Jitendra Pandey, Director, Srijan Rural Development Society. Dr. Shama Rani, Asso. Prof. Dept. of Education & Coordinator, Career Counseling Cell, HGDC, Prayagraj.
2.	WORKSHOP • Workshop On <i>Website Designing</i>	10 Days 18-30 March, 2019	UGC	20	Conducted by: Mr. Prakash, Cyber Net
3.	• Workshop on <i>software echnology</i> - php, mysql, joomla.	30 days 25 Feb.-28 March, 2019	UGC	11	Conducted by Mr. Khalid Ismail, Axoim Business
4.	Faculty Workshop On <i>Website Update</i>	1 st March, 2019	UGC	25	Conducted by Mr. Prakash Srivastava, Cybernet

Awards/Honours/Fellowship received:

S. No.	Name of Faculty Member / Student who received award	Name of the award	Organization conferring award
1.	Ms. Rozy Mukhtar, a student of College	Praiseworthy participation in Matdata Jagrookta Karyakram	Karyalaya Zila Nirvachan Adhikari, Systematic Voters' Education and Electoral Participation

Funding received during the period (amount/purpose/agency) to the College:

S.No.	Agency	Purpose	Amount
1.	UGC	Development of newly sanctioned trade of B.Voc. (Software Technology)	43,30,000/-
2.	NCPUL	Akbar Allahabadi Memorial Lecture	35,000/-
3.	UP Urdu Akademi	For Literary Activity to be organized by Dept. of Urdu, HGDC	1,00,000/-
4.	Allahabad University Annual Grants	Non-Plan, Non-Salary	21,00,000/-

Journals published by the Department / Centre:

S. No.	Title	Nature	Established	Annual/bi-annual /quarterly	ISSN
1.	Naqsh-e-Nau	International	2008	Annual	2320-3781

Proposed Courses

S. No.	Name of Programme	Nature	Duration	Proposed or In process	Intake of Students
1.	Research in Med. History, Sociology & English	Degree Program	3-5 years	Proposed	
2.	M.A. in Journalism	Degree Program	2 years		50
3.	M. Voc. in Fashion Design	Degree Program	2 years		20

4.	B.Sc. in Home Science	Degree Program	3 years		30
5.	Women's Studies as a subject in B.A.				

Other information (about the College)

- 1st - 6th August, 2018 – Placement Drive of B.Voc. – Journalism And Mass Comm.– 8 students selected for internship with Jantantra TV, three students selected for training level – Jantantra TV, 3 students selected for Internship Programme – News 18, 1 student selected for Training – NDTV, 1 students selected for Youth ki Awaz, writers programme, 3 students – Inayosis Pvt. Ltd, 2 students, National Voice News Channel, Lucknow.
- 2nd October, 2018 – (150 Years of Celebrating the Mahatma) Dept. of History in collaboration with Regional Archives, Allahabad, organized Exhibition on *Rare Documents of Freedom Struggle*
- 5th September, 2018 – Students presented a documentary on differently abled entitled, *Parwaz*.
- 2nd October, 2018 – News Portal, *My Nation Media* was launched.
- 17th November, 2018 – Journalism Day was celebrated. Mr. Sameer Atmaj Mishra, Sr. Correspondent of UP, BBC News delivered lecture on *Features of Journalism & New Media*.
- 21st February, 2019 – Students produced a docu drama, *Matr Bhasha : Hamare Sapno ki Bhasha*.

ISWAR SARAN DEGREE COLLEGE

Introduction :

Iswar Saran Degree College, a constituent post graduate college of the University of Allahabad was established in the year 1970 under the aegis of Iswar Saran Ashram with two vibrant units; Gandhi Study Circle and Gandhi Memorial Library as integral part of it.

In the college, graduate and postgraduate classes of basic three streams of Science, Arts and Commerce are running; keeping in mind the future needs of the students and the global challenges the college also runs several vocational courses approved by UGC under different faculties viz. Food Processing and Automobile in B. Voc. Degree program, Computer Application, Computer and Electronic Equipment Maintenance and six add-on courses like mobile repairing, e-commerce, watershed management, microbial bio-fertilizer : production and utilization, computer application 'O' level diploma, and library science.

Thrust Areas:

To gratify the desires of excellence in higher education the College aims;

- ❖ To develop a cohesive center of excellence in teaching and learning to produce best manpower enriched with highly innovative perception and adaptability potential.
- ❖ To prepare the youths to face the interminably changing global challenges.
- ❖ To provide best higher education to youth in general, and with special emphasis on Schedule casts/ Schedule tribes, socially, economically and educationally deprived and disadvantaged groups.
- ❖ To impart knowledge, skills, moral values, traditions and patriotism among students to create a good human-being.
- ❖ To let the youth to cooperate each other and embrace the sorrow of the impoverished and help them as far as possible.

With the prime focus on above objectives the college, apart from its conventional academic programmes of B.A., B.Com., B.Sc., B.Voc. and M.A./M.Sc. is also concentrating on following Professional programmes–

- | | |
|--|--|
| <ul style="list-style-type: none"> ● UGC Approved Vocational Diploma Programs: <ul style="list-style-type: none"> ➤ Diploma in Library science ➤ Diploma in Computer Application ➤ Diploma in Computer and Electronic Equipment Maintenance ➤ Diploma in Mobile repairing ➤ Diploma in E-commerce ➤ Diploma in Watershed management ➤ Diploma in Microbial bio-fertilizer: production and utilization ➤ Diploma in Computer application 'O' level diploma | <ul style="list-style-type: none"> ● Certificate Courses Run by College: <ul style="list-style-type: none"> ➤ Computer awareness ➤ English proficiency ➤ General awareness ➤ Archaeology & museology ➤ Creative writing ➤ Entrepreneurship ➤ E-banking ➤ Finance ➤ Stock Exchange & Security |
|--|--|
- **Academic, Research and Other Activities:**
 - Different departments Regularly organize Special Lectures/Seminars/Symposia, Workshops and Brainstorming sessions on different issues.
 - Faculties Regularly publish Books/Book chapters and Proceedings/Research papers in various International and National Journals.
 - Faculties regularly participate in seminars/symposia/workshops in International & National level.
 - Several Faculties were invited as resource person and key note speaker in Invited talks/Lectures/Seminars organized by national and International Institution with high repute.
 - Regular research and publication by faculty members under UGC-MRP schemes
 - Educational tours for in situ learning in Archaeological and Botanical hot spots
 - Remedial classes for weak students of all faculties.
 - Campus selection drives for recruitment of deserving students from all faculties.

Programmes of Study:

S. No.	Programme of Study	Duration	No. of Seats	Specialization(s)
1.	M.A./M.Sc. (in 11 subjects)	2 years	510	
2.	B.A. B.Sc. B.Com.	3 years 3 years 3 years	1555 492 308	--
3.	B.Voc.	3 years	100	Automobiles & Food Technology
4.	Diploma/Certificate Courses	6 months	50	E-commerce

Details of Students, Year wise and Reservation wise (2018-2019):

Course	Gen			OBC			SC			ST			TOTAL		
	Male	Female	Total	Male	Female	Total	Male	Female	Total	Male	Female	Total	Male	Female	Total
PG	158	129	287	136	84	220	42	25	77	0	0	0	336	248	584
UG	1363	441	1804	1615	437	2052	516	120	636	1	0	1	3495	998	4493
Total	1521	570	2091	1751	521	2272	558	145	713	1	0	1			5077

Seminars/Workshops/Conferences conducted by the College:

S. No.	Name of the Seminar/workshop/conference	National / International	Duration and dates	Funding/sponsor Agenc(y/ies)	No. of Participants	No. of Papers presented
1.	Youth in contemporary India : Issues, Challenges and Opportunities	National	27-28 October, 2019 (2 days)	Indian Council of Social Science Research, New Delhi	250	150
2.	Evaluation in Higher Education in 21 st Century	National	14-15 February, 2019 (2 days)	Indian Council of Social Science Research, New Delhi	200	100
3.	Caste, democratic Politics and Nation Building : Issues, Challenges and Possibilities	National	21-22 February, 2019 (2 days)	Indian Council of Social Science Research, New Delhi	150	100
4.	Faculty, Academic Parameters and Organizational Performance	National	10-11 March, 2019 (2 days)	FDC, PMMMNMTT, MHRD, GOI	250	150

Training/orientation/refresher courses/special lectures conducted by the College:

S. No.	Name of the course	Duration and dates	Funding/sponsor	Speakers
1.	Faculty Induction Training Programme (FDC)	22 November – 21 December, 2018 (30 days)	UNDER PMMMNMTT SCHEME , MHRD, GOI	40 Speakers
2.	Research Methodology Programme (FDC)	07 January – 22 January, 2019 (15 days)	UNDER PMMMNMTT SCHEME , MHRD, GOI	30 Speakers
3.	E-Learning Programme (FDC)	07 February – 13 February, 2019 (7 days)	UNDER PMMMNMTT SCHEME , MHRD, GOI	14 Speakers
4.	Academic Writing Programme (FDC)	23 February – 1 March, 2019 (7 days)	UNDER PMMMNMTT SCHEME , MHRD, GOI	13 Speakers

Funding received during the period:

S.No.	Agency	Purpose	Amount
1.	Allahabad University	Non Plan/Non Salary	56,00000.00
2.	UGC (OBC Grant)	Building	1,61,00000.00
3.	ICSSR	National Seminar	5,50000.00

Research Projects:

S.No.	Title of Project	Duration	Funding Agency	Total Amount	Principal Investigator
1.	Archaeological Survey Work in Allahabad (ASI, New Delhi)	One Year	Applied for	2,50,000.00 (Yet to receive)	Dr A S Singh
2.	<i>Ghazipur mein 1857 : Pratirodh ka lok swaroop va swatantra ke Swar</i>	2 Years	ICHR, New Delhi	3,50,000.00	Dr Narendra Kumar Singh

Academic Organizations (headquartered in the College):

S.No.	Name	Nature	Objectives
1.	Faculty Development Centre (Under Pandit Madan Mohan Malaviya National Mission on Teachers and Teaching (PMMMNTT), MHRD, Govt of India)	National	<ul style="list-style-type: none"> enhance their teaching and other skills. make them aware about modern teaching tools and methodologies. acquire knowledge about current technological developments in relevant fields.

Journals published by the Department/Centre:

S.No.	Title	Nature	Established	Annual/bi-annual /quarterly	ISSN
1.	Journal of Humanities and Social Sciences	National	In Process	Quarterly	Applied for

Other publications by the College

S.No.	Title	Type
1.	Youth in contemporary India : Issues, Challenges and Opportunities	Seminar Proceeding
2.	Evaluation in Higher Education in 21 st Century	Seminar Proceeding
3.	Caste, democratic Politics and Nation Building : Issues, Challenges and Possibilities	Seminar Proceeding
4.	Faculty, Academic Parameters and Organizational Performance	Seminar Proceeding

Proposed Courses

S. No.	Name of Programme	Nature	Duration	Proposed or In process	Intake of Students	Remarks
1.	B.Voc. in Tourism	Degree	3 Years	In Process	30	Apply to UGC
2.	B.Ed.	Degree	2 Years	In Process	60	Apply to AU
3.	B.A./B.Sc in Music / B.Lib / B.J.	Degree	3 Years	In Process	40	Apply to AU
4.	Women Studies	Degree	3 Years	In Process	50	Apply to UGC

Other Projections:

Newly started Self Finance PG Programme will be converted into a regular programme. Being a PG College the research facility will be started in session 2019-20.



Dr Sunil Gupta, Director, Allahabad Museum, Allahabad
(Special lecture was organised on the occasion of World Museum day in the Prof Pramila Srivastava Memorial College Museum)



Workshop on Developing Poetry Skills



Seminar on Faculty, Academic Parameters and Organizational Performance



Seminar on Evaluation in Higher Education in 21st Century

JAGAT TARAN GIRLS' DEGREE COLLEGE

Introduction

Jagat Taran Girls' Degree College was established in year 1975 as an associated college of the University of Allahabad which later became a constituent college of Allahabad Central University w.e.f July 14, 2005. The college is run by Jagat Taran Education Society which comprises of educationists, social thinkers and philanthropists. Famous for its quality teaching at under graduate level (Arts & Commerce), this college has started Post Graduate Courses since session 2017-18.

The College has been accredited with 'A' grade at CGPA of 3.19 by NAAC (II cycle) on November 30, 2011, it has been selected by the UGC as **College with Potential for Excellence** in 2010 and again for CPE (phase II) w.e.f. 2014-15.

Thrust Area

- Quality education comparable to global standards.
- Women empowerment through quality education.
- Development of value oriented and complement human resource for society and nation.
- Holistic development of student's personality through co- curricular and extracurricular activities.
- Pro- active approach towards social, national and global concerns.

Programmes of Study:

S.No	Programme of study	Duration	No. of seats	Specializations
1.	M.A./M.Sc.	2 yr (4 Semester)	170	Sanskrit, Economics, Geography, Hindi
2.	B.A	3yr		
3.	B.COM	3yr		
4.	Diploma in Computer Application (DCA)	1yr		
5	Any Other a) Certificate in Computer Application (CCA) b) Certificate in Web Design (CWD) c) Tally Erp 9	3 Months 3 Months 2 Months	156 156 116	

Details of students, Year Wise and Reservation Wise: (2018-19)

COURSE	Gen	OBC	SC	ST	PWD	TOTAL
M.A.	55	55	6	-	-	116
B.A.	873	907	350	01	01	2132
B.Com.	207	93	17	-	-	317
Diploma in Computer Applications	15	10	02	-	-	27

Funding Received during the Period

S.No	Agency	Purpose	Amount
1	Allahabad University Annual Grants	Maintenance (NCC) from A.U.	2,11,164/-

Proposed projects/SAP/Grants etc.

S. No.	Type of Project/ grant	Title/Name	Duration	Proposed amount	Proposed Or in process
1	Minor research Project	Kashikavritti mein Prativimbit Samajik & Sanskritik Paridrishya, Name – Dr. Pratibha Arya	12 Months	5 Lac	Proposed
2	Minor research Project	Slums, Multidimensional Poverty and Sustainable Development Goals: A Spatial studies of Prayagraj and Varanasi Cities Name Dr. Darshan Kumar Jha	12 Months	5 Lac	Proposed



A Special Lecute on “Hot and Smart Cities ?” by Dr. Komali Yenneti, UNSW,Sydney, Australia



Workshop on Remote Sensing and Geographical Information System by Prof. A.R. Siddqui, University of Allahabad



Maj D.r Archana Paul receiving Governor's Gold Medal by Governor Ram Naik at Lucknow



A Seminar on Effective implementation of Vision and Mission using of ICT in Academic Institution by Prof. Anupam Shukla, Director, IIIT, Pune

K. P. TRAINING COLLEGE

Introduction:

K.P. Training College was established in the year 1951, managed by KayasthaPathshala Trust, one of the biggest educational trust of Asia. Previously the college used to impart L.T. (Licentiate in Teaching) training till 1998. In the year 1999 college became affiliated college of University of Allahabad, Allahabad and started B.Ed. training for aspiring teachers, in the year 2005 University of Allahabad got Central Status with K.P. Training College as one of its Constituent colleges. In the year 2015 one year B.Ed. course was converted into two years B.Ed. course by NCTE/UGC with semester system of examination, college is granted one unit (50 students) of B.Ed. The Students are selected for training through B.Ed. entrance examination every year conducted by University of Allahabad. At Present the college is running B.Ed. course successfully imparting theoretical as well practical knowledge to the trainees.

K.P. Training College aspire to transform its trainees to competent, confident and effective teachers with moral & ethical values. The mission of the college to prepare the pedagogically sound & techno friendly teachers through learner centered approach and training in information technology.

Programmes of Study:

S. No.	Programme of Study	Duration	No. of Seats	Specialization(s)
1.	B.Ed.	2 Years	50	Teacher Training

Details of Students, Programme wise and Reservation wise (2018-2019):

Course	Gen			OBC			SC			ST			PwD			TOTAL		
	Male	Female	Total	Male	Female	Total	Male	Female	Total	Male	Female	Total	Male	Female	Total	Male	Female	Total
B.Ed.	25	14	39	20	11	31	08	08	16	04	02	06	-	-	-	57	35	92

Training/orientation/refresher courses/special lectures conducted by the College:

S. No.	Name of the course/ Work Shop	Duration and dates	Funding / sponsor	Speakers
1.	Lecture on Disaster Awareness Programme	8 Hrs. / 06.10.2018	K.P. Training College	Sri Sai SevaSansthan
2.	Carrier Counseling	3 Hrs./ 08.02.2019	K.P. Training College	सेवायोजन सूचना एवं मंत्रणा केन्द्र इलाहाबाद विश्वविद्यालय
3.	Lecture on Statistics in Education	3 Hrs. / 07/03/2019	K.P. Training College	Prof. S.K. Tyagi Rani Ahilya Bai Holkar University, Indor
4.	Campus Recruitment Drive for "Azim Premji Foundation"		University of Allahabad, Prayagraj	University Placement Cell

Funding received during the period (amount/purpose / agency) to the College:

S. No.	Agency	Purpose	Amount
1.	University of Allahabad	Upgradation	18 Lac. From OBC Grant,
2.	University of Allahabad	Non-Salary Non-Plan Grant	07 Lac.

Proposed Courses

S. No.	Name of Programme	Nature	Duration	Proposed or in process	Intake of Students
1.	M.Ed. Course & Research work	Degree	2 Years	Proposed	50 Students

RAJARSHI TANDON MAHILA MAHAVIDYALAYA

Introduction:

The College was established in the year 1975 as an extension of Gauri Pathshala Inter College (established in 1905). The primary aim of the establishment of this College in the thick locality of Malviya Nagar (Ahiyapur), was to educate and empower the girls of this area who were unable to go to the university for higher education. Late Justice Mahesh Prasad Mehrotra, Late Smt Rani Tandon and late Shri Hari Mohan Das Tandon were founder members of the college management. The College attained Central status and became a constituent of the University of Allahabad in 2005 and received B grade by NAAC in the year 2005 and 2015.

Highlights

- Post Graduation in Hindi and Political Science since 2016.
- B. Com Classes commenced from the session 2018-19
- The college was granted Permission of extension of campus in 2 Acres of land in Hindi Vidyapeeth, Mahewa.

Thrust Areas:

- To provide higher education of excellent quality.
- To inculcate creative impulse and critical thinking in the girl students.
- To sensitise them towards burning social issues such that they may be responsive to social needs.
- To empower them so that they may become independent and self sufficient enriched with moral values and may become responsible citizens of the nation.

Programmes of Study:

S. No.	Programme of Study	Duration	No. of Seats	Specialization(s)
1	M. A	2 Years /4 semesters	50 50	Hindi Political Science
2.	B. A	3 Years	451	Not Required
3.	B.Com	3 Years	60	-

Details of Students, Year wise and Reservation wise (2018-2019):

Course	Gen			OBC			SC			ST			PwD			TOTAL			
	Male	Female	Total	Male	Female	Total	Male	Female	Total	Male	Female	Total	Male	Female	Total	Male	Female	Total	
PG		15	15		08	08		05	05									28	28
UG		49	49		29	29		08	08									86	86
Total		64			37	37		13	13									114	114

Training/orientation/refresher courses/special lectures conducted by the College:

S. No.	Name of the Training /orientation/refresher courses/special lectures	Duration and dates	Funding/sponsor	Speakers
1.	Training of Yoga by Brahmakumaris on International Yoga Day	Three Day Workshop 19 th to 21 st June 2018	College	B K Shailja B K Shraddha
2.	Training for Common Yoga Protocol, Ministry of AYUSH	Three Day Training 19 th to 21 st June 2018	College	Yoga Instructors Shri Prashant Tiwari, Sports Coach Shri Naveen Misra.
3	Inaugural of B Com Classes and Orientation Course for B Com Students	14 th August 2018	College	1. Prof Prahlad Kumar Dean Faculty of Commerce, University of Allahabad. 2.Sri Ratnesh Dixit, UPTEC , Prayagraj

UNIVERSITY OF ALLAHABAD

S. No.	Name of the Training /orientation/refresher courses/special lectures	Duration and dates	Funding/sponsor	Speakers
4.	Career Information and Guidance Programme	One Day workshpo 13 th September 2018	College	<ul style="list-style-type: none"> • Arun Kumar Bhartiya, PCS Officer and Deputy Chief University Employment • Dr Sugreev Singh, University Employment and Information and Guidance Bureau • Shri Sunil Singh, Young Professional in Model Career Centre, University of Allahabad, • Dr. Jitendra Kumar Pandey, Director, SRDS Network Arun Kumar Bhartiya, PCS Officer and Deputy Chief University Employment Bureau,
5	Special Lecture on GST	5 th December 2018	College	Dr. Himanshu Srivatava, Department of Commerce, University of Allahabad
6	Lectures on Women Empowerment	15 th February 2019	College	<ol style="list-style-type: none"> 1. Prof Shabnam Hameed, Head, Dept of Urdu, University of Allahabad, 2. Dr. Rajesh Shastri, Department of Management Studies, MNNIT Prayagraj.

Funding received during the period (amount/purpose/agency) to the College

S.No.	Agency	Purpose	Amount
1.	University of Allahabad	Infrastructure, Taxes, Diesel, Telephone and Electricity Bills	Allocated 12.5 Lakhs



Inauguration of Rajarshi Jayanti



Chief Guest Honourable Vice Chancellor
Prof R L Hangloo addressing the gathering



SWEEP Programme at Kumbh Mela Area on 10.03.2019

Nukkad Natak on Voter Awareness being performed by College students The Programme was organized by District Election Commission Prayagraj.



SADANLAL SANWALDAS KHANNA GIRLS' DEGREE COLLEGE

Introduction:

Our founders Late Mr. S. N. Kakkar, Prof. D.D. Khanna and Mr. Ashok Mohiley were committed to girls' education. They founded the S.S. Khanna Girls' Degree College to impart quality education to girls' from economically and socially backward sections of society. The college starting with humble beginning in 1975 is today a premier constituent college of the University of Allahabad. The college has four faculties: Arts, Science, Commerce and B.Ed. All faculties are doing appreciatively well.

Girl students from the society and economically under privileged class have been beneficiaries and the college has definitely impacted their lives.

National Assessment and Accreditation Council has accredited the college with 'A' Grade and CGPA of 3.46 on four point scale in 2015. In 2016 during the XIIth Plan period, the University Grants Commission conferred the college with "College with Potential for Excellence (CPE-Phase II)".

Thrust Areas:

- Awaring students with their strengths and weaknesses.
- Promoting girls' education especially among disadvantaged class of society.
- Promoting Social work.
- Educational advancement of students according to needs of 21st century.
- Introducing online courses.

Programmes of Study:

S. No.	Programme of Study	Duration	No. of Seats	Specialization(s)
1.	M. A.	2 years	50 per subject	Sociology, Education, English, Hindi Ancient History
	M. A.	2 years	25	Painting
	M. Sc.		40 per subject	Zoology, Botany ,Chemistry
2.	B. A./B. Sc./B.Com	3 years	B.A. : 1257 B.Sc. : 139 B.Com. : 150	
3.	B.Ed.	2 years	100	
4.	Diploma Courses	1 year	31	Biotechnology

Details of Students, Year wise and Reservation wise (2018-2019):

Course	Gen			OBC			SC			ST			PwD			TOTAL		
	Male	Female	Total	Male	Female	Total	Male	Female	Total	Male	Female	Total	Male	Female	Total	Male	Female	Total
PG	0	232	232	0	201	201	0	38	38	0	0	0	0	1	1	0	471	471
UG	0	936	936	0	1094	1094	0	181	181	0	0	0	0	4	4	0	2211	2211
Diploma (Biotech)	0	7	7	0	10	10	0	0	0	0	0	0	0	0	0	0	17	17
B.Ed.	0	91	91	0	78	78	0	26	26	0	3	3	0	2	2	0	198	198
Total	0	1259	1259	0	1373	1373	0	245	245	0	3	3	0	2	2	0	2880	2880

Seminars/Workshops/Conferences conducted by the College:

S. No.	Name of the Seminar/workshop/conference	National / International	Duration and dates	Funding/sponsor Agenc(y/ies)	No. of Participants	No. of Papers presented
1.	National Seminar on "Sustainable Development in India: Issues and Challenges" (Organized by Science Faculty)	National	02 days (27 th and 28 th Nov., 2018)	1) The National Academy of Sciences, India (NASI), Prayagraj 2) IASc., Prayagraj 3) S.S.K.G.D.C, Prayagraj	220	182

Funding received during the period (amount/purpose/agency) to the College

S. No.	Agency	Purpose	Amount
1.	U.G.C.	Grant	72,96,000/-
2.	University of Allahabad	Non plan non salary grant	38,34,332/-
3.	University of Allahabad	OBC grant Building	-
4.	University of Allahabad	OBC grant Equipment	5014289/
5.	University of Allahabad	Salary + Arrear	7,23,20,701/-

Journals published by the department/centre:

S. No.	Title	Nature	Established	Annual/bi-annual /quarterly	ISSN
1.	Anveeksha	National	2018-19	Annual	2581-8163

Proposed Courses

S. No.	Name of Programme	Nature	Duration	Proposed or In process
1.	Ph.D.	Degree	-	Approved in 6 subjects: Hindi, Ancient History, Sociology, Botany, Chemistry and Zoology
2.	5 years Law	Degree	5 years	Under process
3.	Skill Development Programme	Diploma	2 years	Under process
4.	Massive Online Open Courses (MOOCs)	Learning and Certificate Courses		Under Process (20 students have been registered)

Proposed Projects/SAP Grants etc.

S. No.	Type of Project/grant	Title/Name	Duration	Proposed amount	Proposed or in process	Remarks
1.	Start-Up grant	Design, Green synthesis and anti-microbial evaluation of highly functionalized 4-thiazolidino derivatives	2 years	10 Lakh	Has been recommended by UGC	The proposal has been screened and recommended

Photo Gallery



Winners of Damodarshree Award 2018



National Seminar on "Sustainable Development in India: Issues and Challenges" (27th -28th Nov 2018)



Inauguration of new block of building by Honourable Vice Chancellor Prof. R.L. Hangloo



Self Defence Training Under Personality Development Programme under CPE Phase II



Career Development Programme by Mahindra Pride Classroom

SHYAMA PRASAD MUKHERJEE GOVT. DEGREE COLLEGE

Introduction

Established in the year 1997 as a State Government college, the college imparts education in 17 Under Graduate and 7 Post Graduate subjects in the faculties of Art, Science and Commerce. The college has 1800+ enrolled strength of students with 49 faculties on its roll. The College was accredited B in 2012 and was permitted research in Political Science, Commerce and Defence from the academic session 2019-20.

Programmes of Study:

S. No.	Programme of Study	Duration	No. of Seats (Excluding EWS increase)
1	M. A./M. Sc. (self Financing)	2 Years	Zoology : 40 , Botany : 40 , Chemistry : 40, Defence : 30 Anc Hist : 50, Pol Sc. 50, Geog. 30, Commerce : 40, Hindi. : 40
2	B.A.	3 Years	Hindi , English : Sanskrit : Pol Sc. : Philosophy, Anc His : Geog : 62, Def : 62, Zool : 92, Bot : 92, Phy : 92, Chem : 162, Maths :92, Comp Appl : 30, Socio : 30

Details of Students, Year wise and Reservation wise (2018-2019):

Course	Gen			OBC			SC			ST			PwD			TOTAL		
	Male	Female	Total	Male	Female	Total	Male	Female	Total	Male	Female	Total	Male	Female	Total	Male	Female	Total
PG	37	44	81	46	47	93	02	05	07	0	0	0	0	0	0	85	96	181
UG	266	354	620	316	356	672	75	86	161	0	0	0	0	0	0	657	796	1453

Seminars/Workshops/Conferences conducted by the Department/Centre:

S. No.	Name of the Seminar/ workshop/conference	National / International	Duration and dates	Funding/sponsor Agenc(y/ies)	No. of Participants	No. of Papers presented
1.	वैश्विक संस्कृति के विकास में भारत की भूमिका	National	30-31 Jan 2019	Hindustani Academy, Prayagraj	75	20

Training/orientation/refresher courses/special lectures conducted by the College:

S. No.	Name of the course	Duration and dates	Funding/ sponsor	Speakers
1.	Health Awareness Programme	Sept & Oct 2018, 4 Days	Department of Ayush & SIPSA, UP.	Officers deputed by the Health Department
2.	Atal Smriti Vyakhyan	24/08/2018	----	Prof NKS Gaur, Former Minister of Higher Education, UP. Prof K N Singh, Vice-Chancellor, UPRTOU, Allahabad
3.	International Human Rights Day	10 th Dec 2018	-----	Professor M P Dubey, Former Vice-Chancellor, UPRTOU, Prayagraj
4.	International Ahimsa Divas	02 nd October 2018	--	Prof H S Upadhyaya, Registrar, UoA Dr Govind Das, Principal, SPM College

Funding received during the period (amount/purpose/agency) to the College

S.No.	Agency	Purpose	Amount
1.	University of Allahabad	Non-Plan Non-salary Grants for the F.Y. 2018-19 for Infrastructure/Maintenance and contingent expenditure of the college.	Rs 32.50 Lakh
2	UGC	OBC Infrastructure Development Grants	Rs 110.00 Lakh

Proposed Courses

S. N.	Name of Programme	Nature	Duration	Proposed or In process	Intake of Students
1.	Post Graduation in Botany	Degree	2 Years	Permitted by the AU	30
2.	Post Graduation in Defence Studies	Degree	2 Years	Permitted by the AU	30
3	Post Graduation in Physics	Degree	2 Years	Permitted by the AU	30

LIST OF RESEARCH SCHOLARS ENROLLED

DEPARTMENT OF ANCIENT HISTORY, CULTURE & ARCHAEOLOGY

S.N.	Name of the Research Scholars	Area/ Subfield	Topic	Gender	JRF/ NET/ CRET	Categ	Date of Enrollment
1.	Pragya Pandey	Archaeology	Study of Issues of Periodization and Nomenclature in Indian Prehistory	F	JRF	GEN	23.01.2019
2.	Kumari Maya Yadav	Religion	Purva Madayakalin Bharat Mein Bauddha Dharm : Sthiti Evam Prabhav (Uttar Bharat Ke Vishesh Sandarbh Mein)	F	NET	OBC	23.01.2019
3.	Rampriy Yadav	Religion	Nath Samprdaya Ka Ethijasik Evam Sanskritik Adhyayan	M	NET	OBC	23.01.2019
4.	Piyush Mishra	Religion	Purva Madhyakal Me Shaivadharm Ka Adhyayan (Shiva Mahapurana Ke Vishesh Sandarbha Me)	M	NET	GEN	23.01.2019
5.	Neha Yadav	Art	एलोरा की देव प्रतिमाओं का विश्लेषणात्मक अध्ययन	F	NET	OBC	23.01.2019
6.	Akansha Alankrita Bisen	Culture	Society And Culture In Northern India From The 2 nd Century Bce To The 1 st Century Bce (An Epigraphical Study)	F	CRET	GEN	23.01.2019
7.	Renu Singh	Social History	गुजरात के चौलुक्य काल की सामाजिक एवं सांस्कृतिक दशा : एक ऐतिहासिक अध्ययन	F	NET	SC	23.01.2019
8.	Sambhavi Dubey	Culture	पल्लव एवं चोल कालीन मंदिर : सांस्कृतिक क्रियाकलाप के केन्द्र : एक अध्ययन	F	CRET	GEN	23.01.2019
9.	Balram Pathak	Culture	Matsya Purana : Ek Sanskritik Adhyayana	M	JRF	PH	08.04.2019

DEPARTMENT OF ANTHROPOLOGY

S. No.	Name of Research Scholar	Topic	Gender	JRF/ NET/ CRET	Category	Date of Enrollment
1.	Deepika Srivastava	Human rights, Suffering and mental wellbeing among working women: An Anthropological study in Allahabad	F	NET	GEN	09/07/2018
2.	Kumar Aditya	Democratization of Tribal Movement in Post-independent India: An Anthropological Investigation	M	NET	GEN	09/07/2018
3.	Garima Prajapati	Suffering, Tuberculosis and Gender: An Anthropological study in Allahabad	F	NET	OBC	09/07/2018
4.	Preeti Shukla	सामाजिक मीडिया का महिलाओं पर प्रभाव: इलाहाबाद जिला का ग्रामीण एवं नगरीय क्षेत्र का विशिष्ट संदर्भ में एक मानवशास्त्रीय अध्ययन	F	CRET	GEN	09/07/2018
5.	Vinay Kumar Yadav	लददाख क्षेत्र की ब्रोकपा जनजाति की सामाजिक, सांस्कृतिक एवं स्वास्थ्य स्थितियों का मानववैज्ञानिक अध्ययन	M	NET	OBC	09/07/2018
6.	Prabhakar Singh	Socio-Cultural Changes among Tribes: A Study with Special Reference to Chero Tribe of Sonbhadra (Uttar Pradesh) and Palamu (Jharkhand)	M	CRET	OBC	09/07/2018

UNIVERSITY OF ALLAHABAD

S. No.	Name of Research Scholar	Topic	Gender	JRF/ NET/ CRET	Category	Date of Enrollment
7.	Avesh Kumar Gautam	Ethnographic Study of Tribes with Special Reference to Raji in Pithoragarh District of Uttarakhand	M	CRET	SC	09/07/2018
8.	Sakshi Yadav	Estimation of Stature of adult female residents of Prayagraj, Uttar Pradesh	F	CRET	OBC	23/01/2019
9.	Sheevani Mishra	Anthropometric assessment of nutritional status of 3-18 years old children.	F	JRF	GEN	04/12/2018

DEPARTMENT OF ARABIC AND PERSIAN

S.No	Name of research scholar	Area/ Subfield	Topic	Gender	JRF/ NET/ CRET	Category	Date of Enrollment
1.	Haidari Bano	Persian Poetry	Sahme Maulana Imaai Baksh Sahbai Dar Adabiyat-e farsi- e- hind	Female	CRET	Gen	28 Feb 2019

DEPARTMENT OF EDUCATION

S.No.	Name of Research Scholar	Area/ Subfield	Topic	Gender	JRF/ NET/ CRET	Categ.	Date of Enrollment
1.	Rachana Srivastava	Educational Technology	Use of social media for professional development of Secondary school teachers	Female	JRF	Gen	4-12-2018

DEPARTMENT OF ENGLISH AND MODERN EUROPEAN LANGUAGES

S. No.	Name of Research Scholar	Topic	Gender	JRF/ NET/ CRET	Category	Date of Enrollment
1.	Ms. Charu Srivastava	“Split Caribbean In Walcotts Poems: A Critical Study”	F	NET	GEN	23.01.2019
2.	Ms. Preeti Maurya	“Black Feminist Consciousness In The Works Of Alice Walker: A Critical Study”	F	NET	OBC	23.01.2019
3.	Mr. Shariq Khan	“A Study Of Ontemporary English Poetry By Muslim Poets, With Special Reference To Anjum Hasan, Reshma Aquil, Tabish Khair And Rahman”	M	JRF	GEN	23.01.2019
4.	Ms. Shubi Tiwari	“Exploring Theatre As A Troubled Performance Space Negotiating Narratives: A Study In The Light Of Selected Indian Playwrights”	F	NET	GEN	23.01.2019
5.	Mr. Ramanand Jaiswal	“Vedanta And Henry David Thoreau: A Study In Influence”	M	JRF	OBC	23.01.2019
6.	Mr. Satyendra Kumar	“Themes And Techniques: A Comparative Study In The Selected Plays Of Girish Karnad And Mahesh Dattani”	M	NET	SC	23.01.2019

DEPARTMENT OF GEOGRAPHY

S.No.	Name of Research Scholar	Gender	JRF/ NET/ CRET	Category
1.	Ajay Chaturvedi	Male	CRET	General
2.	Pragyan Shukla	Male	JRF	General
3.	Shivam Singh	Male	CRET	General
4.	Manjeev Vishvakarma	Male	JRF	General-OBC
5.	Shashi Singh	Female	JRF	General

S.No.	Name of Research Scholar	Gender	JRF/ NET/ CRET	Category
6.	Priyanka Maurya	Female	JRF	OBC
7.	Shrishti Kushwaha	Female	JRF	OBC
8.	Pavan Kumar	Male	CRET	OBC
9.	Sushila	Female	CRET	SC
10.	Sweta Gond	Female	JRF	ST
11.	Tarun Kumar Patel (PH)	Male	CRET	OBC-PH

DEPARTMENT OF HINDI AND MODERN INDIAN LANGUAGES

S.N.	Name of Research Scholar	Area/ Subfield	Topic	Gender	JRF/ NET/ CRET	Category	Date of Enrollment
1.	संजय कुमार पाण्डेय	नाटक	जयशंकर प्रसाद के नाटकों में राष्ट्रीय सुरक्षा की अवधारणा	Male	JRF	GEN	12.3.19
2.	प्रियंका सिंह	कविता	सांस्कृतिक राष्ट्रवाद की अवधारणा के विकास में छायावाद का योगदान	Female	NET	GEN	12.3.19
3.	श्वेता	पत्रकारिता	चाँद पत्रिका के अंकों में स्त्री लेखन का स्वरूप	Female	NET	OBC	14.3.19
4.	शिवानी जायसवाल	कथेतर गद्य	महादेवी वर्मा के गद्य साहित्य के आयाम	Female	NET	GEN	14.3.19
5.	गौरव सिंह	स्त्री विमर्श	पवन करण की कविताओं में निम्न मध्यवर्ग व स्त्री प्रश्नों की अभिव्यक्ति	Male	JRF	GEN	12.3.19
6.	अम्बरीष कुमार	कथा साहित्य	हिन्दी उपन्यासों में वर्णित वेश संस्कृति: एक समीक्षात्मक अध्ययन (स्वातंत्र्योत्तर हिन्दी उपन्यासों के विशेष संदर्भ में)	Male	JRF	GEN	09.03.19
7.	गौरव पांडे	स्त्री विमर्श	स्त्री विमर्श और अनामिका का साहित्य	Male	CRET	GEN	11.03.19
8.	रीतु यादव	भक्ति काव्य	आदि श्री गुरु ग्रंथ साहिब में सामाजिक और सांस्कृतिक संदर्भों का अनुशीलन	Female	NET	OBC	14.03.19
9.	पुनम वैष्णवी	कथेतर गद्य	हिन्दी के आरम्भिक निबंधकार और नवजागरण की समस्याएँ (1860-1900)	Female	CRET	GEN	
10.	अर्चना मिश्रा	कथा साहित्य	क्षमा शर्मा के उपन्यासों में अभिव्यक्त समकालीन जीवन का परिप्रेक्ष्य	Female	NET	GEN	11.03.19
11.	अनुराग कुमार पांडे	कथा साहित्य	उपेन्द्र नाथ अशक की कहानियों का आलोचनात्मक अध्ययन	Male	JRF	GEN	16.03.19
12.	पंकज कुमार यादव	कथा साहित्य	नासिरा शर्मा के कथा साहित्य में समाज, संस्कृति एवं स्त्री परिप्रेक्ष्य का अध्ययन	Male	JRF	OBC	14.03.19
13.	मनीष कुमार शुक्ला	कथा साहित्य	हिन्दी उपन्यासों में चित्रित महानगरीय संस्कृति एवं जीवन बोध (1990 से 2015 तक)	Male	CRET	PWD	12.03.19
14.	दिनेश कुमार पाल	कथा साहित्य	पंकज सुबीर के कथा साहित्य का समाजशास्त्रीय अध्ययन	Male	NET	GEN	15.03.19
15.	सरिता	कथा साहित्य	नासिरा शर्मा के उपन्यासों में नारी चेतना का स्वर	Female	NET	GEN	11.03.19
16.	कमल चौधरी	कविता	केदार नाथ सिंह की कविताओं में लोक जीवन की अभिव्यक्ति	Male	NET	GEN	14.03.19
17.	वंदना चौहान	कथा साहित्य	श्रीलाल शुक्ल के कथा साहित्य में कल्पना और यथार्थ	Female	JRF	OBC	11.03.19
18.	सौरभ कुमार	कथा साहित्य	भूमंडलीकरण का काशीनाथ सिंह के कथा साहित्य में प्रतिफलन	Male	JRF	OBC	14.03.19
19.	अवनीश यादव	कथा साहित्य	शिवमूर्ति के कथा साहित्य में निम्न मध्यवर्ग की उपस्थिति का अध्ययन	Male	JRF	GEN	14.03.19
20.	राजेश्वरी मौर्या	नवजागरण	शिवपूजन सहाय और हिन्दी नवजागरण	Female	NET	OBC	13.03.19

S.N.	Name of Research Scholar	Area/Subfield	Topic	Gender	JRF/NET/CRET	Category	Date of Enrollment
21.	राजू मिश्रा	कविता	समकालीन कविता और उदयप्रकाश के काव्य में युगबोध	Male	NET	GEN	11.03.19
22.	जीनत ज़या	कथा साहित्य, तुलनात्मक साहित्य	प्रेमचंद के उपन्यासों के हिन्दी, उर्दू पाठ का तुलनात्मक अध्ययन	Female	JRF	GEN	15.03.19
23.	रमेश चंद्र सोनी	कथेतर गद्य	हिन्दी का पर्यावरण साहित्य एवं अनुपम मिश्र का लेखन	Male	NET	GEN	14.03.19
24.	कुमकुम यादन	कथा साहित्य	हिन्दी कहानी में संरचनात्मक परिवर्तन का अध्ययन (1990 के बाद से अब तक)	Female	NET	OBC	14.03.19
25.	सिद्धार्थ कुमार	भक्ति काव्य	साहित्यिक मूल्यों के विकास की दृष्टि से संत काव्य का अध्ययन	Male	NET	SC	14.03.19
26.	सरोज तिवारी	कविता	गंगा प्रसाद विमल का साहित्य: प्रयोगधर्मिता के विविध आयाम	Female	NET	GEN	11.03.19
27.	नीतू यादव	कविता	विनोद कुमार शुक्ल का काव्य संसार: भाषा और संवेदना के स्वरूप का अध्ययन	Female	JRF	GEN	
28.	सचिन कुमार गुप्ता	कविता	साठोत्तरी हिन्दी कविता: विवेचन एवं मूल्यांकन	Male	JRF	GEN	14.03.19
29.	नारायण दत्त तिवारी	कथा साहित्य	21वीं शताब्दी के हिन्दी उपन्यासों में प्राचीन भारत: इतिहास और समकाल का द्वंद्व	Male	JRF	GEN	11.03.19
30.	जुगेश कुमार गुप्ता	नाटक और रंगमंच	आधुनिक हिन्दी रंगमंच के विकास में राष्ट्रीय नाट्य विद्यालय का योगदान	Male	NET	GEN	14.03.19
31.	रजत सिंह	कथेतर गद्य	राष्ट्रीय स्वतंत्रता आंदोलन और प्रेमचंद का कथेतर गद्य साहित्य	Male	JRF	PWD	11.03.19
32.	शैलेन्द्र मणि त्रिपाठी	स्त्री विमर्श	महिला आत्मकथाओं का आलोचनात्मक अध्ययन (पितृसत्ता, लिंगभेद, वैश्वीकरण के विशेष संदर्भ में)	Male	CRET	GEN	11.03.19
33.	अमरदीप यादव	कविता	समकालीन हिन्दी कविता का सांस्कृतिक आधार एवं भाषाई स्वरूप (राजेश जोशी, जानेंद्रपति, लीलाधर जगूड़ी के विशेष संदर्भ में)	Male	JRF	OBC	
34.	निशा सिंह पटेल	स्त्री विमर्श	21वीं सदी की हिन्दी कहानी में नारी विद्रोह के स्वर	Female	NET	GEN	14.03.19
35.	सुनीता	कथेतर गद्या	आधुनिक हिन्दी व्यंग्य साहित्य और शरद जोशी का कृतित्व: एक अध्ययन	Female	JRF	OBC	12.03.19
36.	मोहम्मद असद	तुलनात्मक साहित्य	दलित और पसमांदा साहित्य का तुलनात्मक अध्ययन	Male	JRF	OBC	14.03.19
37.	रागिनी सिंह	कथा साहित्य	राही मासूम रज़ा के उपन्यासों में अभिव्यक्त युगीन चेतना: एक अध्ययन	Female	NET	GEN	12.03.19
38.	सुभाष चंद्र	आलोचना	डॉ. धर्मवीर की कबीर विषयक आलोचनाओं का समीक्षात्मक अध्ययन	Male	NET	GEN	11.03.19
39.	गरिमा सिंह	नाटक और रंगमंच	असगर वजाहत के नाटक साहित्य में अभिव्यक्त राजनीतिक चेतना का परिप्रेक्ष्य	Female	CRET	GEN	14.03.19
40.	अनुपम गुप्ता	कथा साहित्य	हाशिफ़ के विमर्श और चित्रा मुद्गल के उपन्यास	Male	NET	GEN	11.03.19

S.N.	Name of Research Scholar	Area/Subfield	Topic	Gender	JRF/NET/CRET	Category	Date of Enrollment
41.	निशांत कुमार सिंह	कथा साहित्य	ग्रामीण जीवन का बदलता स्वरूप और हिन्दी उपन्यास (गोदान, मैला आंचल ,राग दरबारी एवं महाभोज के विशेष संदर्भ में)	Male	NET	GEN	11.03.19
42.	सविता वर्मा	कथा साहित्य	उदारीकरण का युग एवं हिन्दी कथा साहित्य में किसान जीवन (2001-2016)	Female	NET	OBC	16.03.19
43.	नीरज यादव	कथा साहित्य	शिवमूर्ति के कथा साहित्य में नारी जीवन का समाजशास्त्रीय अध्ययन	Male	NET	OBC	14.03.19
44.	विवेक कुमार पांडेय	कविता	21वीं सदी की हिन्दी कविता में व्यंग्य और विद्रोह के स्वर	Male	CRET	GEN	16.03.19
45.	सुमन मौर्या	स्त्री विमर्श	आदिकालीन साहित्य में अभिव्यक्त स्त्री जीवन का आलोचनात्मक अध्ययन	Female	CRET	OBC	12.03.19
46.	जूली पाठक	आदिकाव्य	पउमचरित और रामचरित मानस का तुलनात्मक अध्ययन	Female	JRF	GEN	12.03.19
47.	नेहा साहु	कथा साहित्य	समकालीन सामाजिक संदर्भ और संजीव का कथा साहित्य	Female	JRF	GEN	11.03.19
48.	विनय कुमार पांडेय	कथा साहित्य, दलित विमर्श	हिन्दी कहानी में अभिव्यक्त स्त्री एवं दलित प्रश्न (संदर्भ 21वीं शताब्दी का प्रथम दशक)	Male	CRET	GEN	13.03.19
49.	आशा मिश्रा	कथा साहित्य	सुधा अरोड़ा के साहित्य में आधी आबादी का संघर्ष	Female	NET	GEN	11.03.19
50.	बच्चा सिंह	कथा साहित्य	समकालीन हिन्दी उपन्यासों में किन्नर संवेदना	Male	CRET	PWD	14.03.2019
51.	नीशू सिंह	कविता	समकालीन कविता और केदारनाथ सिंह का कवि व्यक्तित्व: एक अध्ययन	Female	JRF	GEN	14.03.19
52.	राहुल कुमार यादव	कथा साहित्य	कमलेश्वर के कथा साहित्य में अभिव्यक्त चेतना के विविध आयाम: एक अध्ययन	Male	JRF	OBC	
53.	बबिता कुमारी सरोज	दलितविमर्श	दलित लेखकों की आत्मकथाएँ: समाजशास्त्रीय अध्ययन	Female	JRF	SC	13.03.19
54.	चंद्रकला	कथा साहित्य	कृष्णा सोबती एवं भीष्म साहनी के कथा साहित्य का वैचारिक एवं शिल्पगत आधार पर तुलनात्मक अध्ययन	Female	NET	OBC	23.03.19
55.	विवेक कुमार तिवारी	आदिकाव्य	लोक भाषा एवं लोक साहित्य के संवर्धन में नाथपंथ की भूमिका	Male	CRET	GEN	14.03.19
56.	शिवांक त्रिपाठी	कथा साहित्य	रामदरश मिश्र के उपन्यासों में सामाजिक यथार्थ	Male	JRF	GEN	11.03.19
57.	प्रतिमा	कथा साहित्य	कोमल रोमांस के खिलाफ स्त्री के दुःस्वप्नों के कथाकार दूधनाथ सिंह	Female	JRF	OBC	
58.	उमेश चौधरी	कथा साहित्य	शिवमूर्ति के कथा साहित्य में ग्रामीण जीवन संघर्ष की अभिव्यक्ति	Male	CRET	PWD	14.03.19
59.	निवेदिता सिंह	कथा साहित्य	हिन्दी उपन्यास में अभिव्यक्त भूमंडलीकरण एवं विज्ञान प्रौद्योगिकी से बदलता समाज का स्वरूप (संदर्भ 1990 से अब तक)	Female	JRF	GEN	15.3.19
60.	संगीता मिश्रा	कथेतर गद्य	वैश्वीकरण युग की कथेतर गद्य सर्जना: सर्वेक्षण एवं प्रवृत्तियाँ (1990 से अब तक)	Female	JRF	GEN	14.3.19
61.	सरोज यादव	कथा साहित्य	संजीव के कथा साहित्य में दलित स्त्रियों की समस्याएँ		NET	GEN	13.03.19

S.N.	Name of Research Scholar	Area/ Subfield	Topic	Gender	JRF/ NET/ CRET	Category	Date of Enrollment
62.	सत्यदरश यादव	कथा साहित्य	भूमंडलीकरण एवं 21वीं सदी के हिन्दी कथा साहित्य की प्रवृत्तियाँ (सन 2000 से अद्यतन)	Male	NET	GEN	13.03.19
63.	सर्वेश यादव	कथा साहित्य	हिन्दी कथा साहित्य में किन्नर पात्रों की मनोदशा का सामाजिक अध्ययन	Male	NET	GEN	
64.	अरविंद कुमार सोनी	सिनेमा अध्ययन	हिन्दी साहित्यिक कृतियों पर आधारित फिल्मों में निहित सामाजिक चेतना का आलोचनात्मक अध्ययन	Male	JRF	OBC	11.03.19
65.	ज्योति वर्मा	कथेतर गद्य	समकालीन स्त्री आत्मकथाओं में पराधीनता के विविध संदर्भ	Female	JRF	GEN	14.03.19
66.	जागृति	नाटक और रंगमंच	सुरेन्द्र वर्मा के साहित्य में स्त्री निर्मिति	Female	JRF	SC	16.03.19
67.	श्रद्धा त्रिपाठी	कथेतर गद्य	1990 के बाद के हिन्दी संस्मरण साहित्य में इलाहाबाद का साहित्यिक वृत्त	Female	NET	GEN	12.03.19
68.	शुभांकर सिंह	संत साहित्य	इक्कीसवीं शताब्दी के आलोक में संत साहित्य की आलोचनात्मक स्थापनाओं का अनुशीलन	Male	JRF	GEN	11.03.19
69.	आलोक गुप्त	कथा साहित्य	राहुल सांकृत्यायन के कथा साहित्य में चित्रित इतिहास और संस्कृति	Male	NET	OBC	14.03.19

DEPARTMENT OF MEDIEVAL AND MODERN HISTORY

S. No.	Name of Research Scholar	Area/ Subfield	Topic	Gender	JRF/ NET/ CRET	Categ.	Date of Enrollment
1.	Anil Kumar	Modern History	Landless Peasants and Indian National Movements in Uttar Pradesh	Male	JRF	SC	23/01/2019
2.	Arvind Yadav	Modern History	Bhojpuri Cinema Ek Aitihāsik Adhyayan	Male	JRF	OBC	23/01/2019
3.	Anjul Kumar	Modern History	Urban Poor Women in Allahabad and Kanpur in the age of Liberalization	Male	JRF	GEN	23/01/2019
4.	Anuruddha Kumar	Modern History	Rise of Identity Politics in India with Special Reference to Globalization	Male	JRF	GEN	23/01/2019
5.	Ajay Kumar	Modern History	Sanyukt Prant A Mein Dalit aur Dalit Andolan	Male	NET	SC	23/01/2019
6.	Gaurav	Modern History	Mahatma Gandhi Evam Bhartiya Rashtriya Congress ke Madhya Vaicharik Bhinnata	Male	JRF	OBC	23/01/2019
7.	Govind Mishra	Modern History	Annihilation of Caste: A Comperative and Critical Analysis of Ideas of Mahatma Jyotirao Phule, Babsaheb Dr. B R Ambedkar and E V Ramaswamy Periyar	Male	CRET	GEN	23/01/2019
8.	Hema Singh	Modern History	Political Partition and Mobalization of Women In Allahabad during the Indian National Movement	Female	CRET	OBC	23/01/2019
9.	Om Pal Singh	Modern History	Curriculum and Caste: Question of Caste Hegemony in India after Independence	Male	NET	SC	23/01/2019

UNIVERSITY OF ALLAHABAD

S. No.	Name of Research Scholar	Area/ Subfield	Topic	Gender	JRF/ NET/ CRET	Categ.	Date of Enrollment
10.	Pragya	Medieval History	Rise of Agra and its significance: A Historical Analysis	Female	CRET	GEN	23/01/2019
11.	Rita Singh Rana	Modern History	Colonial Rule and the Tribes of Kumaun and Garhwal	Female	CRET	ST	23/01/2019
12.	Suyash Mishra	Medieval History	Development and Science and Technology in Madras Presidency 1900 - 1947	Male	CRET	GEN	23/01/2019
13.	Sambhrant Shukla	Modern History	Representation of Indian Partition in Hindi Cinema	Male	JRF	GEN	23/01/2019

DEPARTMENT OF MUSIC AND PERFORMING ARTS

S. No.	Name of Research Scholar	Area/ Subfield	Topic	Gender	JRF/ NET/ CRET	Categ.	Date of Enrollment
1.	Baldeep Kaur	Vocal	<i>Gurmat Sanget Ka Bhartiya Sangeet Mein Yogdan</i>	Female	NET	Gen	04.12.2018
2.	Kamini Nishad	Tabla	<i>Natyashastra Mein Varnit Avnaddh Vadya Ki Pari Sampatiyon Ka Madhyakaal Tatha Adhunik Kal Ke Pariprekshya Vishleshnatmak Adhyayan</i>	Female	JRF	OBC	04.12.2018
3	Shashi Roy	Tabla	<i>Tabla Vadan Mein Saundaryaparak Tatvon Ka Vishleshnatmak Adhyayan</i>	Female	JRF	Gen	04.12.2018
4	Shivam Kushwaha	Vocal	<i>Vartman Samay Mein Dhrupad Gayan Shaili Ka Prachar Prasar Evam Bhavishya Ek Adhyayan</i>	Male	--	OBC	04.12.2018
5	Darshi Srivastava	Tabla	<i>Acharya Bharat Ke Ras Siddhant Ka Avnaddh Vadyon Ke Pariprekshya Mein Vishleshnatmak Adhyayan</i>	Female	NET	Gen	04.12.2018
6	Anju Pandey	Vocal	<i>Dhrupad Ke Shailigat Saundarya Tatvon Ka Vishleshnatmak Adhyayan (Dagur Vani Parampara Ke Pariprekshya Mein)</i>	Female	NET	GEN	04.12.2018
7	Manisha Bharti	Sitar	<i>Sitar Vadan Ke Vibhinn Gharanon Ka Itihas Evam Vadan Shaili Aur Kalakaron Ka Yogdan</i>	Female	--	SC	23.01.2019
8	Akash Kumar	Vocal	<i>Kalyan That Ke Yaman Rag Ka Vishleshnatmak Adhyayan, Vobhinna Gayan Shailiyon Gharanon Evam Uplabd Rachnaon Ke Sandarbh Mein.</i>	Male	--	SC	23.01.2019
9	Vikky Kumar (PH)	Tabla	<i>Uttar Pradesh Ki Sangeet Parampara Mein Divyangon Ki Stithi Va Unke Yogdaan Ka Adhyayan (Tabla Vadya Ke Vishesh sandarbh Mein)</i>	Male	JRF	OBC	23.01.2019
10	Ganesh Kumar Special Case	Tabla	<i>Shastiya Up Shastriya Evam Sugam Sangeet Mein Tabla Ki Sangati Ka Asthan Tatha Unme Prayog Hone Wale Taalon Ki Upyogita</i>	Male	NET	SC	28.02.2019

DEPARTMENT OF PHILOSOPHY

S. No.	Name of Research Scholar	Area/ Subfield	Topic	Gender	JRF/ NET/ CRET	Category	Date of Enrollment
1.	Vipul Kumar Tiwari	Ethics	A Discourse on Legal Ethics with Reference to Abortion Capital Punishment and Euthanasia	Male	JRF	Gen	4.12.2018

S. No.	Name of Research Scholar	Area/ Subfield	Topic	Gender	JRF/ NET/ CRET	Category	Date of Enrollment
2.	Anjali Sharma	Ethics	A Critical and Comparative Study of Ethics of Virtue with Special Reference to Aristotle, David Hume and Christine Swanton	Female	CRET	OBC	4.12.2018
3.	Neda Parveen	Ethics	A Critical Survey of Ethics Intuitionism with Special Reference to Ralph Cudworth, Joseph Butler, George Edward Moore and William David Ross	Female	CRET	OBC	4.12.2018
4.	Poonam Tripathi	Philosophy of Religion	A Critical Study on the Arguments to Prove the Existence of God : With Special Reference to Ontological Argument	Female	CRET	Gen	23.1.2019
5.	Deeksha	Socio-political Philosophy	A Critical Study of Socio-political Philosophy of Mahatma Gandhi	Female	CRET	Gen	23.1.2019
6.	Anurag Chaudhary	Socio-political Philosophy	A Critical Study of Communism and Socialism as Political Ideologies	Male	CRET	SC	23.1.2019

DEPARTMENT OF PHYSICAL EDUCATION

S. No.	Name of Research Scholar	Topic	Gender	JRF/ NET/ CRET	Category	Date of Enrollment
1.	Sandeep Kumar Dwivedi	“Analytical study of physical fitness among gymnastics, athletics and Volleyball players at high school level of Uttar Pradesh”	Male		Gen	08.04.2019
2.	Ajeet Kumar Rai	“Effect of yogic practices on muscular fitness and selected psychological variable of college students”	Male	Net	Gen	08.04.2019

DEPARTMENT OF POLITICAL SCIENCE

S.N.	Name of Research Scholar	Area/ Subfield	Topic	Gender	JRF/ NET/ CRET	Category	Date of Enrollment
1.	Anam Mobin	Indian Political System	“Impact of Information And Communication Technology On Indian Political System In The 21 st Century”	Female	JRF	UR	08-03-2019
2.	Tarushi Pandey	Indian Political System	“Role Of Indian Judiciary In Promotion & Protection of Human Rights In The 21 st Century”	Female	CRET	UR	08-03-2019
3.	Pratima Singh	Indian Political System	“भारत में घरेलू हिंसा-2005 के पश्चात (उत्तर प्रदेश के प्रतापगढ़ जनपद के विशेष संदर्भ में)”	Female	CRET	UR	08-03-2019
4.	Vaishali Kumari	Environmental Politics	“जलवायु परिवर्तन की वैश्विक राजनीति भारतीय दृष्टिकोण का अध्ययन”	Female	CRET	UR	08-03-2019
5.	Roshani Shukla	Terrorism	“अन्तर्राष्ट्रीय आतंकवाद का महिलाओं पर प्रभाव का अध्ययन जम्मू-कश्मीर के विशेष संदर्भ में”	Female	CRET	UR	08-03-2019
6.	Rohit Kumar	Area Studies	“भारत-बिस्स्टेक(BIMSTEC)संबंध: क्षेत्रीय सहयोग में बढ़ती प्रासंगिकता	Male	CRET	UR	08-03-2019

S.N.	Name of Research Scholar	Area/ Subfield	Topic	Gender	JRF/ NET/ CRET	Category	Date of Enrollment
7.	Sujeet Kumar Yadav	International Relations	“संयुक्त राज्य अमरीका और उत्तर कोरिया के मध्य तनाव का विश्व राजनीति पर प्रभाव का मूल्यांकन”	Male	CRET	OBC	08-03-2019
8.	Prabha Singh	Indian Administration	“नगरीय स्थानीय स्वशासन में महिलाओं की सहभागिता: लखनऊ जनपद उत्तर प्रदेश के विशेषसंदर्भ में”	Female	CRET	OBC	08-03-2019
9.	Abhishek Kushwaha	Internal Relations	“भारत जापान सम्बन्ध: उत्तर शीतयुद्ध काल (1921-2014)	Male	CRET	OBC	08-03-2019
10.	Kajol	Indian Political System	“Judicial Activism in India in 21 st Century”	Female	CRET	SC	08-03-2019
11.	Ankur Singh	Indian Political System	“भारतीय लोकतांत्रिक व्यवस्था में निर्वाचन प्रणाली एवं चुनाव सुधार की आवश्यकता: एक समीक्षात्मक अध्ययन”	Male	CRET	SC	08-03-2019
12.	Susheel Kumar Kori	International Relations	“21वीं शताब्दी में भारत-रूस रणनीतिक साझेदारी: आगे की चुनौतियाँ	Male	CRET	SC	08-03-2019
13.	Vikash Gupta	Women Empowerment	“भारत में महिला सशक्तिकरण के प्रयासों का मूल्यांकन”	Male	CRET	OBC	08-03-2019
14.	Suraj Srivastava	India's Foreign Policy	Indian Foreign Policy Towards European Union after 2000: A Case Study of Germany	Male	JRF	SC	08-03-2019
15.	Shesh Mani Sharma	Public Policy	“उज्ज्वला गैस योजना का मतदान व्यवहार का प्रभाव: उत्तरप्रदेश के बहराइच और श्रावस्ती जिले के विशेष अध्ययन में”	Male	CRET	UR	08-03-2019
16.	Uma Pandey	International Relations	“OBOR परियोजना के संदर्भ में भारत-चीन रिश्तों की बदलती रूपरेखा (Changing Dynamics of India – China Relations in the Context of OBOR Initiative”)	Female	CRET	UR	08-03-2019
17.	Anurag Singh	Gandhian Studies	“Gandhian Concept of Conflict Resolution in Modern World”	Male	JRF	UR	08-03-2019
18.	Rajesh Kumar Raman	Local Administration	“भारत में स्थानीय स्वशासन की अवधारणा का समीक्षात्मक अध्ययन”	Male	CRET	UR	08-03-2019
19.	Mukesh Kumar	International Relations	India Turkey Relation in 21 st Century : Gandhian Perspective	Male	JRF	OBC	08-03-2019
20.	Krishna Choudhury	Indian Thought	“कौटिल्य के राजनीतिक विचारों की वर्तमान भारत में प्रासंगिकता : सुशासन के सन्दर्भ में”	Male	JRF	SC	08-03-2019
21.	Ravi Shanker Pandey	Strategic Studies	“Geo-Political & Strategic Important of Maldives in Indian Ocean with Special Reference to India China Conflict”	Male	CRET	UR	08-03-2019
22.	Rana Yashwant Pratap Singh	UN and Human Rights	“संयुक्त राष्ट्र मानवाधिकार परिषद का मानव अधिकारों के सम्बन्ध में भूमिका का विश्लेषण (2007 से वर्तमान तक)”	Male	CRET	UR	08-03-2019

UNIVERSITY OF ALLAHABAD

S.N.	Name of Research Scholar	Area/ Subfield	Topic	Gender	JRF/ NET/ CRET	Category	Date of Enrollment
23.	Ajay Kumar Yadav	Ethnic Studies	“पाकिस्तान में नृजातीय संघर्ष, क्षेत्रीय सुरक्षा हेतु निहितार्थ”	Male	CRET	OBC	08-03-2019

DEPARTMENT OF PSYCHOLOGY

S. No.	Name of Research Scholar	Area/ Subfield	Topic	Gender	JRF/ NET/ CRET	Category	Date of Enrollment
1.	Aditya Banerjee	Health Psychology	Understanding Loneliness and its Outcomes	Male	NET & CRET	General	08.04.2019
2.	Alok Pratap Singh	Organizational Behaviour	Work Engagement: Role of Individual and Organizational Factors	Male	NET & CRET	General	08.04.2019
3.	Ankit Mishra	Social Psychology	Understanding Acts of Violence	Male	JRF & CRET	General	08.04.2019
4.	Ankita Singh	Social Psychology	Correlates of Intergroup Forgiveness	Female	NET & CRET	OBC	08.04.2019
5.	Ayushi Maurya	Organizational Behaviour	Leadership Styles, Employees' Job Attitudes and Organizational Effectiveness in Indian Organization	Female	NET & CRET	OBC	08.04.2019
6.	Sonoo	Health Psychology	Understanding Antisocial Behaviours of Adolescents	Male	NET & CRET	SC	08.04.2019

DEPARTMENT OF SOCIOLOGY

S. No.	Name of Research Scholar	Topic	Gender	JRF/ NET/ CRET	Category	Date of Enrollment
1.	Shalini Yadav	Ethnic Identity And Social Mobility Among The Marginalized Sections : A sociological Study of Musahar Community In Eastern U.P.	Female	CRET	OBC	10-01-2018
2.	Shivani Jaiswal	Development, Migration And Social Justice for Migrants : A Study of Migrant Workers In Informal Sector of Allahabad City	Female	CRET	OBC	09-01-2018
3	Bhagyashree Ojha	Concerns for sanitation w.r.t. religious gathering during holy dip in U.P. : A Sociological study of Magh Mela in Allahabad District	Female	JRF	GEN	04-12-2018

DEPARTMENT OF URDU

S.N.	Name of Research Scholar	Topic	Gender	JRF/ NET/ CRET	Category	Date of Enrollment
1.	Afreen Fatima	Munshi prem chand aur Thomas hadry ke novelon ke fikr-o- fan ka taqabuli mutala	Female	JRF	OBC	13/03/2018
2.	Salama Ansari	Beesvin sati mein urdu mein tanisi shayeri ki rewayat	Female	Net	OBC	13/03/2018
3.	Mohd Raihanul Haque	Ghalib aur iqbal ke mushtar ka mauzuat ka taqabuly mutalea (urdu shayri ke hawale se)	Male	Net	Gen	13/03/2018

S.N.	Name of Research Scholar	Topic	Gender	JRF/NET/CRET	Category	Date of Enrollment
4.	Devendra Singh	Urdu mein qaumi – o- watni shayeri ki rewayat aur durga Prasad suroor jahanabadi ki shayri	Male	Net	Sc	13/03/2018
5.	Asna Sahar	Urdu mein inshaiya nigari ki rewayat sir syed se rasheed Ahmad Siddiqi Tak	Female	Net	OBC	13/03/2018

DEPARTMENT OF VISUAL ARTS

S.N.	Name of Research Scholar	Area/ Subfield	Topic	Gender	JRF/NET/CRET	Category
1.	Pooja Kushwaha	Visual Arts	“Uttar Pradesh Ki Samkaleen Chitrakala Mein Antarnihit Samay Avam Samaj Ka Adhyayan”	Female	CRET	OBC
2.	Yuvraj	Visual Arts	“Uttar Pradesh Ki Samkaleen Chitrakala Mein Mithkeey Chetna Ka Adhyayan”	Male	JRF/NET	OBC
3.	Anuj Kumar Verma	Visual Arts	“Uttar Pradesh Ki Samkaleen Chitrakala Mein Lok-Chetna Ka Adhyayan”	Male	JRF/NET	OBC
4.	Rakhi Sonkar	Visual Arts	“Kalacharya Dr. Abhay Dwivedi Ke Vyaktitva Avam Krititva Ka Adhyayan”	Female	JRF/NET	SC

DEPARTMENT OF COMMERCE & BUSINESS ADMINISTRATION

S. No.	Name of Research Scholar	Area/ Subfield	Topic	Gender	JRF/NET/CRET	Category	Date of Enrollment
1.	Abhay Pandey	Human Resource Management	Impact of Participation on industrial relation with specselect Multinational Corporations(MNCs) in India	Male	NET	General	28/02/2019
2.	Anubhav Agarwal	Taxation	A study on Tax audit in India: Challenges, Threat and Prospects	Male	JRF	General	28/02/2019
3.	Anuj Pandey	Financial Management	A study of Relationship Between stock markets Dynamics in economic Growth In India	Male	CRET	General	28/02/2019
4.	Bhavna Srivastava	Taxation	Impact of GST on Unorganised retail sector with special referance to Uttar Pradesh	Female	NET	General	28/02/2019
5.	Chandan Kumar Gautam	Economic Environment	Impact of Monetary policy on Indian Economy in the post reform era	Male	JRF	SC	28/02/2019
6.	Ekta Singh	Marketing Management	Impact of Branding on consumer behavior with special reference to Fast moving consumer goods	Female	CRET	OBC	28/02/2019
7.	Gurave Singh	Taxation	Goods and Service tax in India:Its Implication and sustainability on various stakeholders	Male	NET	PH	28/02/2019
8.	Jivesh Nandan	Financial Management	Relevance of CAPm in pricing Securities in Indian Stock market :A study of pre and ppost Finamncial crisis 2008	Male	NET	SC	28/02/2019

S. No.	Name of Research Scholar	Area/ Subfield	Topic	Gender	JRF/ NET/ CRET	Category	Date of Enrollment
9.	Kuldip Singh	Financial Management	Impact of credit risk management on financial performance of Indian banking sector :A comparative study of select public and private sector banks	Male	JRF	OBC	28/02/2019
10.	Kushboo Husain	Financial Management	Corporate Governance Practices and its impact on Financial performance in Banking sector :A study of select banks	Female	CRET	General	28/02/2019
11.	Shalini Kushwaha	Financial Management	Financial Market integration :An vidence from Equity Market interlinkges among BRIC countries	Female	JRF	OBC	28/02/2019
12.	Shivam Bajpai	Marketing Management	A study of Public procurement system in India Through GEM :Challenges and reforms	Male	CRET	General	28/02/2019
13.	Suneel Kumar Patel	Commerce	NTPC Ltd Evam Hindalco industries Ltd mein Nigmay Samajik Uttar daitva Vyapar ka Tulatmak adhyan	Male	NET	OBC	28/02/2019
14.	Smita Dixit	Marketing Management	Impact of Media convergence on Socio Economic Status and Lifestyles	Female	CRET	General	28/02/2019
15.	Surbabhi Kesarwani	Financial Management	Impact of Mergers and Acquisition on the operational efficiency of banks in India	Female	CRET	General	28/02/2019
16.	Vishnu Sahu	Marketing Management	Impact of online advertising on Fast Food industry :A case study of selected districts of Eastern Uttar Pradesh	Male	CRET	OBC	28/02/2019
17.	Yashhasw i Pandey	Tourism	Bharat mein adhyatmik Paryatan ki sambhavnayan va Chunaautiyan Uttar Pradesh ke sandarbh mein	Male	CRET	General	28/02/2019

DEPARTMENT OF ECONOMICS

S. No.	Name of Research Scholar	Gender	JRF/ NET/ CRET	Category
1.	Shafia Zahra	F	JRF	GEN
2.	Akash Verma	M		OBC
3.	Akash kumar Baranwal	M	NET	GEN
4.	Ritu Verma	F	NET	OBC
5.	Mahesh Pandey	M	CRET	GEN
6.	Archna Maurya	F	JRF	OBC
7.	Kiran Kumari	F	JRF	OBC
8.	Kumud Kanajiya	F	NET	SC
9.	Phiroj Ahmad (P.H)	M	JRF	OBC
10.	Sugandh Kumar Chaudhary (Teacher)	M	NET	GEN

DEPARTMENT OF LAW

S. No.	Name of Research Scholar	Area/ Subfield	Topic	Gender	JRF/ NET/ CRET	Cat	Date of Enrollment
1.	Abhilash Kumar Srivastava	Law	Status of Jammu & Kashmir Under Indian Constitution : A Socio Legal Study	M	NET	GEN (PH)	23.01.2019
2.	Manoj Kumar Yadav	Law	Legal Protection of Traditional Knowledge And Medicinal Plants In India : A Critical Study	M	NET	OBC	23.01.2019
3.	Ravi Yadav	Law	Goods And Services Tax : A Critical Study	M	NET	OBC	23.01.2019
4.	Trikalagya Tiwari	Law	Control of Corruption Through The Instrumentality of Law : A Critical And Comparative Analysis of Prevention of Corruption Act, 1988	M	NET	GEN	23.01.2019
5.	Abhishek Gupta	Law	Right To Privacy : A New Judicial Approach And Its Impact on Socio Economic Condition of Indian Society	M	NET	OBC	23.01.2019
6.	Rahul Prakash	Law	A Critical Review of Environmental Protection In India In The Light of Human Rights Jurisprudence	M	NET	OBC	23.01.2019
7.	Mayuri Mehrotra	Law	Judicial Activism Under Article 21 of The Constitution of India With Special Reference To Women's Rights	F	NET	GEN	23.01.2019
8.	Shubendu Mishra	Law	Indian Constitution on Education And Educational Institutions : A Critical Study	M	NET	GEN	23.01.2019
9.	Kanchan Kumari Meena	Law	Socio-Legal Study of Refugee System In India With Special Reference To Rohingyas	F	NET	ST	23.01.2019
10.	Tushar Srivastava	Law	Right to Information and its Relevancy in Contemporary India – Issues and Challenges	M	NET	GEN (TW)	23.01.2019
11.	Krishnakant Verun Kumar	Law	“साइबर सम्बन्धित समस्याओं का भारतीय विधियों के सन्दर्भ में : एक विश्लेषणात्मक अध्ययन”	M	NET	ST	23.01.2019
12.	Avinash Kumar Singh	Law	Role of National Green Tribunal In Achieving the Aim of Environmental Justice : A Critical Study	M	NET	SC	23.01.2019
13.	Aditya Rathi	Law	Critical Study of Scientific Investigative Techniques in India With Special Reference to Criminality and Personal Liberty	M	NET	GEN	23.01.2019

DEPARTMENT OF BIOCHEMISTRY

S. No.	Name of Research Scholar	Area/ Subfield	Topic	Gender	JRF/ NET/ CRET	Category	Date of Enrollment
1.	Rupali Srivastava	Toxicology and Free Radical Biology	Biochemical efficacy of naringenin in alleviating xenobiotic induced oxidative stress and toxicity	Female	CRET	GEN	23/01/2019

UNIVERSITY OF ALLAHABAD

S. No.	Name of Research Scholar	Area/ Subfield	Topic	Gender	JRF/ NET/ CRET	Category	Date of Enrollment
2.	Jitendra Kumar Arya	Gerontology	Studies on inhibition of glucose metabolism as an anti-aging strategy	Male	CRET	OBC	23/01/2019
3.	Rishabh Kumar		Genetic polymorphism in DNA repair and Glutathione S-transferase gene among north Indian population: Association to head and neck cancer	Male	CRET/ CSIR-UGC JRF	OBC	23/01/2019
4.	Jyotsna Jaiswal	Biochemistry	Phytochemical analysis and biochemical characterization of some medicinal plant extracts with special reference to their antioxidative and antimicrobial potential	Male	CRET	OBC	23/01/2019
5.	Vinay Pratap	Biochemistry	Investigation of Biologically active compounds from medicinal plants and their evaluation as therapeutic agents	Male	NET/ CRET	SC	23/01/2019

DEPARTMENT OF BOTANY

S. No.	Name of Research Scholar	Area/ Subfield	Topic	Gender	JRF/ NET/ CRET	Categ.	Date of Enrollment
1.	Kamleshwar Singh	Botany	Algal Biosorption of Heavy Metals and Effluents	Male	NET-JRF	OBC	12/04/2018
2.	Tajammul Husain	Botany	Regulatory Role of Ethylene and Hydrogen Sulfide in Hexavalent(VI) Chromium Challenged Some Pulse Crops: Assessment of Physiological and Biochemical Activities	Male	CRET	OBC	12/04/2018
3.	Mohammad Suhel	Botany	Study On Roles of Gamma-Aminobutyric Acid And Nitric Oxide in The Regulation of Arsenate Toxicity in Some Vegetable Crops	Male	CRET	OBC	12/04/2018
4.	Kaushal Tripathi	Botany	Induced Mutagenesis in Trifolium Species with Special Reference to Cyto-Taxonomy	Male	CRET	Gen	12/04/2018
5.	Prabhat Kumar	Botany	Studies On Flora Of Sonbhadra District, Uttar Pradesh, India.	Male	CRET	SC	12/04/2018
6.	Moni Mishra	Botany	Cytogenetical and Biochemical Assay of Induced Mutant Lines in Foeniculum Vulgare Mill.	Female	CRET	Gen	12/04/2018
7.	Shikha Arora	Botany	Herbicidal Potential of Crop Plants	Female	CRET	Gen	12/04/2018
8.	Pratibha	Botany	Harvesting Microalgae Using Bioflocculation	Female	CRET	OBC	12/04/2018
9.	Zeba Azim	Botany	Role of Nanoparticles on Growth and Development of Plants Under Heavy Metal Stress	Female	CRET	OBC	12/04/2018

UNIVERSITY OF ALLAHABAD

S. No.	Name of Research Scholar	Area/ Subfield	Topic	Gender	JRF/ NET/ CRET	Categ.	Date of Enrollment
10.	Lata Kaushik	Botany	Studies on Flora of Mirzapur District, Uttar Pradesh, India	Female	CRET	SC	12/04/2018
11.	Neeraj Pandey	Botany	Physiological and biochemical responses of some cyanobacteria exposed to copper and its nanoparticles	Male	CRET	Gen	22/05/2018
12.	Sani Kumar Singh	Botany	Assessment Of Heavy Metal Stress On Some Cereal Crops:Management Approach for Toxicity Alleviation	Male	CRET	Gn	02/07/2019
13.	Shailendra Kumar	Botany	Morphological, cultural and Molecular studies of Alternariabrassiccae strains occurring in the fields of Allahabad and adjoining areas.	Male	CRET	SC	12/04/2018

DEPARTMENT OF CHEMISTRY

S. No.	Name of Research Scholar	Area/ Subfield	Gender	JRF/ NET/ CRET	Category	Date of Enrollment
1.	Ved Prakash	Inorganic	Male	JRF	OBC	28.02.2019
2.	Ankit Verma	Organic	Male	JRF	OBC	28.02.2019
3.	Mohd. Nazeef	Organic	Male	JRF	OBC	28.02.2019
4.	Harendra Singh	Physical	Male	JRF	OBC	28.02.2019
5.	Ramakant	Inorganic	Male	JRF	OBC	28.02.2019
6.	Sandeep Singh	Inorganic	Male	JRF	OBC	28.02.2019
7.	Aditya Kumar Yadav	Organic	Male	CRET	OBC	28.02.2019
8.	Jyoti Singh	Inorganic	Female	CRET	SC	08.04.2019
9.	Mukta Singh	Inorganic	Female	CRET	SC	08.04.2019
10.	Nand Kumar Ram	Inorganic	Male	CRET	SC	28.02.2019
11.	Arpit Srivastava	Inorganic	Male	CRET	GEN	08.04.2019
12.	Vijay Pandey	Physical	Male	CRET	GEN	28.02.2019
13.	Saurabh Kumar Pathak	Environmental Science	Male	CRET	GEN	28.02.2019
14.	Mubashra Afroz	Environmental Science	Female	CRET	GEN	28.02.2019
15.	Saumya Agrahari	Environmental Science	Female	CRET	GEN	28.02.2019
16.	Pravesh Kumar	Agriculture Chemistry	Male	CRET	OBC	28.02.2019
17.	Adarsh Bhushan	Agriculture Chemistry	Male	CRET	OBC	28.02.2019

DEPARTMENT OF DEFENCE AND STRATEGIC STUDIES

S. No.	Name of Research Scholar	Topic	Gender	JRF/ NET/ CRET	Category	Date of Enrollment
1.	Amrita Tiwari	“India-Vietnam Strategic Relation”	Female	JRF	GEN	12.04.2018
2.	Abhishek Pandey	“Prospectus of Blue Economy : A Study of India’s Maritime Security.”	Male	NET	GEN	12.04.2018

3.	Col. Sunil Mishra	“India- Pakistan Strategic Relations”	Male	Armed Forces	GEN	12.04.2018
4.	Mr. Akhilesh Chandra Shukla	“Indo –U S Strategic Partner-Ship : Problems and Prospect in 21 st century”	Male	NET	GEN	04.12.2018
5.	Mr. Praveen Singh	“ Separatist Movement in Balochistan policy options for India”	Male	NET	GEN	04-12-2018

DEPARTMENT OF EARTH & PLANETARY SCIENCES

S. No.	Name of Research Scholar	Area/ Subfield	Topic	Gender	JRF/ NET/ CRET	Categ.	Date of Enrollment
1.	Rahma Rafat	Environmental Geology	Geo-hydrological and biological controls over the heavy metal concentration and dispersion in the natural domains	Female	CRET	GEN	14/02/2019
2.	Shailendra Kumar Chaudhary	Neotectonics	The geomorphic and morphometric inference of stress patterns in a neo-tectonic frame-work a case study of Kumaun Himalaya	Male	CRET	SC	21/02/2019

DEPARTMENT OF ELECTRONICS AND COMMUNICATION

J.K. Institute of Applied Physics & Technology, University of Allahabad

S. No.	Name Of Research Scholar	Area/ Subfield	Topic	Gender	JRF/ NET/ CRET	Category	Date of Enrollment
1.	Aditya Kumar Singh	ECE	Investigation Of Feed Techniques, Bandwidth And Gain Enhancement Methods In Microstrip Patch Antenna	Male	CRET	General	23/01/2019
2.	Pradeep Kumar Tiwari	ECE	Study And Performance Analysis Of Next Generation Communication Network	Male	CRET	General	23/01/2019
3.	Piyush Kumar Mishra	ECE	Some Investigations On Different Aspects Of Reconfigurable And Smart Antenna	Male	CRET	General	23/01/2019
4.	Animesh Tripathi	ECE	Broad Band Millimeter Wave Propagation For 5g Cellular Networks: Mobility And Channel Characterization	Male	CRET	General	23/01/2019
5.	Meenal Job	ECE	Devising Robust Tamers Suppression In Mimo Radar Antennas	Female	CRET	General	23/01/2019
6.	Vandana Yadav	ECE	Modelling Performance Of Hillimeter-Waved And Microwave Devices Using Simulation Techniques	Female	CRET	OBC	23/01/2019
7.	Shiksha Singh	CSE	Medical Image Analysis For Disease Detection And Diagonis Using Deep Learning	Female	CRET	General	23/01/019
8.	Komal Singh	CSE	Development Of Computational Methods For Classification And Detection Of Neuro-Degenerative Diseases	Female	CRET	General	23/01/2019
9.	Shalini Dhar	CSE	Development Of Security Algorithms For Image & Video Data	Female	CRET	General	23/01/2019
10.	Monika Dubey	CSE	Ai Based Approach To Enhance Network Slicing In 5g Network	Female	CRET	General	23/01/2019

S. No.	Name Of Research Scholar	Area/ Subfield	Topic	Gender	JRF/ NET/ CRET	Category	Date of Enrollment
11.	Mohit Gupta	CSE	Big Data Processing And Analytics For Iot Enabled Environment	Male	CRET	General	23/01/2019
12.	Rahul Mishra	CSE	Design And Analysis Of Models And Algorithms For Wireless Sensor Networks Based On Machine Learning Approach	Male	CRET	General	23/01/2019
13.	Vidhu Kant Mishra	CSE	Study And Design Of Methodology For Link Prediction In Online Social Networks	Male	CRET	General	23/01/2019
14.	Jyoti Mishra	CSE	Application Of Data Mining Methods In Health Care Data	Female	CRET	General	28/02/2019
15.	Pawan Mishra	CSE	Enhanced Evolutionary Algorithms And Their Applications	Male	CRET	General	23/01/2019

DEPARTMENT OF HOME SCIENCE

S. No.	Name of Research Scholar	Area/Subfield	Topic	Gender	JRF/ NET/ CRET	Category	Date of Enrolment
1.	Itee Ojha	Textiles and Apparel Designing	Mythological abstract designing through CAD and their application on fabric	Female	CRET	General	January 23, 2019
2.	Vandana Shukla	Textiles and Apparel Designing	Mass media body images and self esteem of teenage girl	Female	CRET	General	January 23, 2019

DEPARTMENT OF MATHEMATICS

S. No.	Name of Research Scholar	Area/ Subfield	Topic	Gender	JRF/ NET/ CRET	Category	Date of Enrollment
1.	Ashish Kumar Pandey	Algebra	A Study on Some Problems in Number Theory	M	NET/ CRET	General	23.01.2019
2.	Chandan Singh Kharvar	Algebra	Some Topics on Transversals in Groups	M	CRET	ST	23.01.2019
3.	Nirbhay Kumar	Algebra	A study on Some Classes of Rings and Modules	M	CRET	General	23.01.2019
4.	Reda Fatma	Mathematical Modelling	Study of Diffusive and non-Diffusive Phenomena Through Mathematical Modelling	F	CRET	OBC	23.01.2019
5.	Rohit Kumar Verma	Algebra	A Study on Rings and Modules over certain Rings	M	JRF	OBC	23.01.2019
6.	Sarvesh Kumar Yadav	Differential Geometry	Semi- Riemannian maps between semi-Riemannian manifolds equipped with certain structures	M	JRF	OBC	23.01.2019
7.	Satish Kumar	Fluid Mechanics	A Study of Some Non-Newtonian Viscous Fluid Flow Problems	M	JRF	SC	23.01.2019

DEPARTMENT OF PHYSICS

S. No.	Name of Research Scholar	Area/ Subfield	Topic	Gender	JRF/ NET/ CRET	Category	Date of Enrollment
1.	Divya Tripathi	Nano Science & Technology	Synthesis And Characterization Of Nano Particles (Titanium Dioxide, Graphene) And Their Applications In Pollution Control	F	CRET	GEN	23.01.2019
2.	Pratima Mishra	Spectroscopy of Materials	Evolution Of The Analytical Techniques For The Analysis Of Different Materials	F	CRET	GEN	23.01.2019
3.	Darpan	Spectroscopy of Materials	Composition Study Of Perilous Materials Using Spectroscopic Technique	F	CRET	GEN	23.01.2019
4.	Pankaj Kumar	Organic Electronics	Charge Transport And Design Considerations Of Organic And Hybrid Thin Film Field Effect Transistor	M	CRET	GEN	23.01.2019
5.	Aradhana Tripathi	Application of Spectroscopy	Potential Of Vibrational Micro Spectroscopic Techniques As A Non Destructive, Label Free And Rapid Probe For The Detection Of Bio Molecular Response Of The Interaction Of Nano Particles With Plants	F	CRET	GEN	23.01.2019
6.	Ashish Varma	Plasma Physics	Tera Hertz (THz) Radiation Generation And Electron Acceleration In Plasma	M	JRF	OBC	23.01.2019
7.	Tejmani Kumar	Spectroscopic Techniques of Materials	Study On Edible Materials Using Spectroscopic Techniques	M	CRET	OBC	23.01.2019
8.	Ashok Vishwakarma	Photovoltaics	Studies On Lead Free Photo – Active Hybrid Perovskite Materials For Photo Voltaic Applications	M	CRET	OBC	23.01.2019
9.	Anshika Singh	Nano Science & Technology	Investigation Of Core Shell Type Nano Structures	F	CRET	SC	23.01.2019
10.	Arvind Kumar	Plasma Physics	Non Linear Interaction Of High Power Laser With Plasma	M	CRET	SC	23.01.2019
11.	Jyoti Yadav	Nano Science & Technology (Interdisciplinary)	Rate Of Nano Particles /Membranes For Purification Of Waste Water	F	CRET	OBC	23.01.2019
12.	Chhavi Baran	Spectroscopy of biological materials	Non-Destructive Probing Of Biochemical Response Of Nanotoxicity On Plants By Microspectroscopic Techniques	F	CRET	SC	23.01.2019
13.	Aradhana Tripathi	Spectroscopy of biological materials	Potential Of Vibrational Micro-Spectroscopic Techniques As A Non-Destructive, Label Free And Rapid Probe For The Detection Of Biomolecular Response Of The Interaction Of Nanoparticles With Plants	F	CRET	GEN	23.01.2019

DEPARTMENT OF STATISTICS

S. No.	Name of Research Scholar	Area/ Subfield	Topic	Gender	JRF/ NET/ CRET	Category	Date of Enrollment
1.	Ms. Deepti Tripathi	Reliability/Survival analysis	On some Inferential Aspects of Survival Data	Female	CRET	Gen.	11.3. 2019

DEPARTMENT OF ZOOLOGY

S. No.	Name of Research Scholar	Topic	Gender	JRF/ NET/ CRET	Cat.	Date of Enrollment
1.	Priyanka Agrawal	Evaluation of developmental psychopathological potential of some new generation CNS acting drugs: A postnatal study	Female	UGC JRF	General	23.01.2019
2.	Pallavi Singh	Assessment of developmental neurotoxic potential of some novel psychotropic drugs: A prenatal study	Female	UGC CRET	OBC	23.01.2019
3	Himanshu Pal	Neuroendocrine control of metabolism: Role of neurotensinergic system	Male	UGC CRET	OBC	23.01.2019
4	Pradeep Verma	Neuroendocrine control of reproduction: Role of neurotensinergic system	Male	UGC CRET	SC	23.01.2019

CENTRE OF BIOTECHNOLOGY

S. No.	Name of Research Scholar	Area/ Subfield	Topic	Gender	JRF/ NET/ CRET	Categ.	Date of Enrollment
1.	Swati Gupta	Plant Bio-technology	Studies on phytochemical and pharmacological profiling of citrus fruit peels and seeds and their role as functional ingredient.	F	CRET	OBC	04/12/2018

CENTRE OF BIOINFORMATICS

S. No.	Name of Research Scholar	Area/ Subfield	Topic	Gender	JRF/ NET/ CRET	Category	Date of Enrollment
1.	Ms. Nidhi Singh	Bioinformatics	“In silico metagenomic studies of microbes of environmental concerns”	F	CRET	Gen	23 oct 2018

CENTRE FOR DEVELOPMENT STUDIES

S. No.	Name of Research Scholar	Area/ Subfield	Topic	Gender	JRF/ NET/ CRET	Categ.	Date of Enrollment
1.	Arpita Singh	Development Studies	Interlinkages of liberalization, hunger mitigation and food security: a critical study of Public Distribution System in Uttar Pradesh from 1991- 2015	F	CRET	GEN	23/01/2019
2.	Adarsh Singh	Development Studies	Relationship between Democratic Governance and its Impact on Development: An Analytical study	M	CRET	GEN	23/01/2019

S. No.	Name of Research Scholar	Area/ Subfield	Topic	Gender	JRF/ NET/ CRET	Categ.	Date of Enrollment
			of Socio-Political Discourses and Welfare Policies in Uttar Pradesh from 1991 to 2015.				
3.	Prakhar Anand	Development Studies	Dynamics of vulnerability and Livelihood Strategies: An Analytical Study of Urban Poor in Selected Districts of Uttar Pradesh from 2000-2018	M	CRET	SC	23/01/2019
4.	Prakash Singh	Development Studies	Dynamics of Urbanization and Ecology: A Critical Study of Development of Green Spaces in The Indo-Gangetic Plains with Special Reference to Uttar Pradesh	M	CRET	OBC	23/01/2019
5.	Saket Pandey	Development Studies	Public Policy and its Formation: A Study of India's Renewable Energy Policies with Special Reference to India's Security Needs in the 21 st Century	M	CRET	GEN	23/01/2019
6.	Pratibha Singh	Development Studies	Social Security in the Era of Globalization: A Study of Women's Social Security Measures in India, 2000-2015	F	CRET	GEN	23/01/2019

K. BANERJEE CENTRE OF ATMOSPHERIC AND OCEAN STUDIES

S. No.	Name of Research Scholar	Area/ Subfield	Topic	Gender	JRF/ NET/ CRET	Category	Date of Enrollment
1.	Akhil Srivastava		Performance of ocean coupled "Weather research and forecast modeling system for hurricanes: (HWRF) in track and intensity forecast of tropical cyclones over north Indian Ocean"	Male		GEN	28/02/2019
2.	Devanshu Kanaujia	Land-atmosphere interactions	Earth System Science/Modeling land-atmosphere interactions	Male	CRET	SC	23/10/2018
3.	Harshita Saxena	Monsoon	Understanding the Impact of Aerosol on Indian Monsoon	Female	DST_In spire	GEN	23/10/2018
4.	Mayank Pandey	Artificial Intelligence	Application of machine learning for predictability in atmospheric and oceanic science.	Male	CRET	GEN	23/10/2018
5.	Mohd Akbar Ali	Air quality	Understanding the impacts of land use/land cover change on air quality in a part of Ganga river basin	Male	CRET	OBC	23/10/2018
6.	Rizwan Ahmed			Male	CRET	OBC	2018
7.	Sapna Shamra	Water Resources	Estimation of changes in hydro meteorological feedback fluxes and water storage In a part of Ganga river basin India	Female	DST_In spire	GEN	09/07/2018

UNIVERSITY OF ALLAHABAD

S. No.	Name of Research Scholar	Area/ Subfield	Topic	Gender	JRF/ NET/ CRET	Category	Date of Enrollment
8.	Shambhavi Krishna	Climate change	Impact of weather conditions on human health in India with reference to climate change.	Female	DST_In spire	GEN	23/10/2018
9.	Shehnaz Mulla	Agriculture	Assessment of water parameter impact for current & future	Female	CRET	OBC	09/07/2018
10.	Siddharath Srivastava	Ocean modeling	Role of fresh water discharge on the Dynamics of Bay of Bengal	Male	CRET	GEN	23/01/2019
11.	Vijay Kumar	Water resources	Investigation of impact of land use land cover change on water quality and Environmental flow in an agriculturally dominant river basin	Male	CRET	SC	28/02/2019

CENTRE OF MATERIAL SCIENCES

S. No.	Name of Research Scholar	Area/ Subfield	Topic	Gender	JRF/ NET/ CRET	Category	Date of Enrollment
1.	Amir Iqbal	Soft Material	Impact of Dispersion of nanoparticles on Dielectric and electro-optical parameters of ferroelectric liquid crystals materials	Male	CRET	GEN	23.01.2019
2.	Himanshu Verma	Soft Material	Synthesis, Dispersion and Characterization of nanoparticles in liquid crystals	Male	CRET	OBC	23.01.2019
3.	Shrish Nath Upadhyay	Nano Material	Investigation on synthesis and characterization on ionbeam irradiated oxide materials	Male	CRET	GEN	23.01.2019
4.	Preeti Yadav	Multiferroic Composite Material	Synthesis and Characterization of multiferoic Martials	Female	CRET	OBC	23.01.2019
5.	Akanksha Khare	Soft Materials	Characterization and applications of Liquid Crystals and their Nano-Composites in Electro-opticals and Electronic Devices	Female	CRET	GEN	23.01.2019
6.	Abhinav Lal	Soft Materials	Liquid Crystals-Nanorods Composites : Infusion and Characterization	Male	CRET	GEN	23.01.2019
7.	Saikumar Chirra	Soft Materials	Preparation and Characterization of ferro and antiferroelectric Liquid Crystals –Nanoparticles Composites	Male	CRET	GEN	23.01.2019

CENTRE OF SCIENCE AND SOCIETY (Rural Technology and Development)

S. No.	Name of Research Scholar	Area/ Subfield	Topic	Gender	JRF/ NET/ CRET	Categ.	Date of Enrollment
1.	Anjali Yadav	Rural Technology and Development	innovative initiative and Entrepreneurship for menstrual health of rural	Female	CRET	OBC	04.12.2018

S. No.	Name of Research Scholar	Area/ Subfield	Topic	Gender	JRF/ NET/ CRET	Categ.	Date of Enrollment
			women				
2.	Brijesh Kumar Pandey	Rural Technology and Development	Studies on utilization of water bodies for fresh water edible fish production	Male	CRET	Gen	04.12.2018
3.	Vipin Mishra (PH)	Rural Technology and Development	Studies on ornamental fish farming	Male	CRET	Gen	04.12.2018

CENTRE OF BEHAVIORAL AND COGNITIVE SCIENCES

S. No.	Name of Research Scholar	Area/ Subfield	Topic	Gender	JRF/ NET/ CRET	Category	Date of Enrollment
1.	Mr. Ishan Singhal	Consciousness and cognition	Temporal properties of consciousness	Male	CRET	General	Provisionally admitted
3.	Mr. Anurag	Language and cognition	Anticipation and language processing	Male	CRET	OBC	Provisionally admitted
4.	Ms. Ganga Tiwari	Cognitive development	Social affective competence and performance in children	Female	CRET	General	Provisionally admitted
5.	Ms. Tripti Verma	Cognitive development	Executive functions and performance in children	Female	CRET	General	Provisionally admitted

DOCTORAL DEGREES AWARDED IN 2018-19

Sl.No.	Name of Candidate	Department	Name of Supervisor	Date of R.D.C.
1	Mr. Ahsish Kumar Yadav	Hindi	Prof. Meera Dixit	09/07/2018
2	Mr. Avdhesh Yadav	English	Prof. Gunjan Shushil	09/07/2018
3	Mr. Ram Murti Pathak	Philosophy	Prof. Jata Shankar	09/07/2018
4	Mr. Sher Bahadur Yadav	Ancient History	Prof. Ranjana Bajpai	09/07/2018
5	Mr. Vimlesh Kumar Ojha	Ancient History	Prof. A.P. Ojha	09/07/2018
6	Ms. Aditi Pandey	Sanskrit	Prof. Uma Kant Yadav	09/07/2018
7	Ms. Sangeeta	Hindi	Dr. Surya Narayan Singh	09/07/2018
8	Mr. Alok Ranjan Srivastava	Hindi	Dr. Surya Narayan Singh	08/08/2018
9	Mr. Devi Prashad Gupta	Sanskrit	Prof. K.K. Srivastava	08/08/2018
10	Mr. Mayank Shekhar jha	Sanskrit	Prof. Suchitra Mitra	08/08/2018
11	Mr. Mohd. Yasheen	Urdu	Prof. Sabanam Hameed	08/08/2018
12	Mr. Prabhat Kumar	Sanskrit	Prof. Uma Kant Yadav	08/08/2018
13	Ms. Fatima Noori	English	Prof. Sonjoy Dutt Ray	08/08/2018
14	Ms. Pooja Mishra	Music	Dr. P.K. Malik	08/08/2018
15	Ms. Sonam Seth	Music	Dr. Dharm Pal	08/08/2018
16	Ms. Suman Pandey	Education	Prof. Usha Mishra	08/08/2018
17	Mr. Anand Pandey	Ancient History	Prof. G.K. Rai	14/09/2018
18	Mr. Arshad Jameel	Urdu	Prof. Naushaba Sardar	14/09/2018
19	Mr. Narendra Pratap Singh Yadav	Med./Mod. History	Prof. P.L. Vishwakarma	14/09/2018
20	Mr. Pawan Raj Chaudhary	Music	Dr. Dharm Pal	14/09/2018
21	Mr. Sandeep Kumar	Anthropology	Prof. A.R.N. Srivastava	14/09/2018
22	Mr. Sandeep Kumar Yadav	Sanskrit	Prof. Uma Kant Yadav	14/09/2018
23	Ms. Hema	Sanskrit	Prof. Suchitra Mitra	14/09/2018
24	Ms. Stuti Swivedi	Philosophy	Prof. Rishi Kant Dwivedi	14/09/2018
25	Ms. Vandana Yadav	Education	Prof. Usha Mishra	14/09/2018
26	Ms. Vinita Singh	Psychology	Prof. Deepa Punetha	14/09/2018
27	Mohd. Irfan	Urdu	Prof. A.A. Fatimi	23/10/2018
28	Mr. Arun Kumar	Sanskrit	Prof. Uma Kant Yadav	23/10/2018
29	Mr. Atul Kumar Dubey	Sanskrit	Prof. Ram Sewak Dubey	23/10/2018
30	Mr. Deepak Kumar Pandey	Hindi	Prof. Mustaq Ali	23/10/2018
31	Mr. Dhananjay Singh	Political Science	Prof. H.K. Sharma	23/10/2018
32	Mr. Mohd. Saquib Taufique	Education	Prof. P.K. Sahoo	23/10/2018
33	Mr. Rajneesh Kumar Soni	Ancient History	Prof. J.N. Pal	23/10/2018
34	Mr. Ravindra Kumar Mishra	Ancient History	Prof. Suniti Dwivedi	23/10/2018
35	Mr. Shivaji	Hindi	Dr. Pranay Krishna	23/10/2018
36	Ms. Ankita Mishra	Music	Dr. V.D.P. Mishra	23/10/2018
37	Ms. Aysa Aman	Urdu	Prof. Atiya Nishat Khan	23/10/2018
38	Ms. Kiran Pal	Ancient History	Prof. J.N. Pal	23/10/2018
39	Ms. Kishwar Jahan	Psychology	Prof. Rashmi Kumar	23/10/2018
40	Ms. Madhu Shukla	Sanskrit	Prof. H.D. Sharma	23/10/2018
41	Mr. Bhupendra Pratap Singh	Sanskrit	Prof. Ram Sewak Dubey	25/10/2018
42	Mr. Amit Tiwari	English	Prof. Deepika Srivastava	04/12/2018

UNIVERSITY OF ALLAHABAD

Sl.No.	Name of Candidate	Department	Name of Supervisor	Date of R.D.C.
43	Mr. Manish Kumar Mishra	Philosophy	Prof. D.N Dwivedi	04/12/2018
44	Mr. Prashant Kumar Bharti	Ancient History	Prof. A.P Ojha	04/12/2018
45	Mr. Pratyush Singh	Geography	Prof. B.N Singh	04/12/2018
46	Mr. Satish Pratap Singh	Sanskrit	Prof. Ram Sewak Dubey	04/12/2018
47	Ms. Pratima Bhartiya	Hindi	Prof. Kripa Shankar Pandey	04/12/2018
48	Ms. Rizwana Shamsi	Urdu	Prof. A.A Fatimi	04/12/2018
49	Ms. Shweta Singh	Hindi	Dr. Lalsa Yadav	04/12/2018
50	Mr. Drupad Kumar	Ancient History	Prof. J.N Pal	14/12/2018
51	Ms. Ayana Bose	Music	Dr. P.K Malik	14/12/2018
52	Ms. Anjana	Med./Mod. History	Prof. P.L Vishwakarma	24/12/2018
53	Mr. Anurag Pal	Ancient History	Prof. A.P Ojha	23/01/2019
54	Mr. Chandra Shekhar Yadav	Geography	Prof. A.R Siddqui	23/01/2019
55	Mr. Dharm Vijay Singh	Hindi	Prof. Katyayni Singh	23/01/2019
56	Mr. Dheeraj Kr. Shukla	Sanskrit	Prof. K.K Srivastava	23/01/2019
57	Mr. Dinesh Kumar Sharma	Ancient History	Prof. U.C Chattopadhyay	23/01/2019
58	Mr. Rajnikant Rai	Ancient History	Dr. Shashikant Rai	23/01/2019
59	Mr. Wiriya	Philosophy	Dr. Gopal Sahu	23/01/2019
60	Ms. Anjali Upadhyay	Sanskrit	Prof. Suchitra Mitra	23/01/2019
61	Ms. Ankita Mukharji	Music	Dr. Rashmi Dixit	23/01/2019
62	Ms. Preeti Singh	Music	Dr. Rashmi Dixit	23/01/2019
63	Ms. Priyanka Pandey	Psychology	Prof. Komila Thapa	23/01/2019
64	Ms. Sarita Dubey	English	Prof. Indrani Kukherjee	23/01/2019
65	Ms. Sushil Kumar	Ancient History	Prof. O.P Srivastava	23/01/2019
66	Ms. Vidya	Music	Dr. Rashmi Dixit	23/01/2019
67	Mr. Amit Kumar Singh	Philosophy	Prof. Rishi Kant Pandey	25/01/2019
68	Mr. Anil Kumar Yadav	Political Science	Prof. H.K Sharma	28/02/2019
69	Mr. Anurag Dwivedi	Geography	Prof. Manorma Sinha	28/02/2019
70	Mr. Arun Kumar Tripathi	Geography	Prof. Manorma Sinha	28/02/2019
71	Mr. Arvind Tripathi	Geography	Prof. Manorma Sinha	28/02/2019
72	Mr. Rajneesh Tiwari	Ancient History	Prof. Harsh Kumar	28/02/2019
73	Mr. Utharsh Upadhyay	Political Science	Prof. Sanjeev Kumar H.M	28/02/2019
74	Ms. Amrita Mishra	Music	Dr. Rashmi Dixit	28/02/2019
75	Ms. Anamika Mishra	Ancient History	Prof. G.K Rai	28/02/2019
76	Ms. Arti Saroj	Sanskrit	Prof. K.K Srivastava	28/02/2019
77	Ms. Pooja Dwivedi	Music	Dr. Rashmi Dixit	28/02/2019
78	Ms. Pooja Mishra	Philosophy	Prof. Rishi Kant Pandey	28/02/2019
79	Ms. Rinshi Patel	Sanskrit	Prof. Uma Kant Yadav	28/02/2019
80	Ms. Vandana Bhartiya	English	Dr. Jaya Kapoor	28/02/2019
81	Ms. Vandana Singh	Sanskrit	Prof. Manjula Jaiswal	28/02/2019
82	Ms. Vishal Pandey	Sanskrit	Prof. Suchitra Mitra	28/02/2019
83	Mohd. Saleem	Urdu	Prof. Shabanam Hameed	08/04/2019
84	Mr. Abhay Kumar Yadav	Philosophy	Prof. Devashish Guha	08/04/2019
85	Mr. Chandan Prasad	Education	Prof. P.K. Sahoo	08/04/2019
86	Mr. Ghazanfar Sayeed	Urdu	Prof. Nausaba Sardar	08/04/2019
87	Mr. Jenmejy Singh	Ancient History	Prof. D.K. Shukla	08/04/2019
88	Mr. Mahendra Kumar	Political Science	Prof. Pankaj Kumar	08/04/2019
89	Mr. Radha Swami Maurya	Ancient History	Prof. J.N. Pal	08/04/2019
90	Mr. Rahul Kumar Dubey	Hindi	Prof. Mustaq Ali	08/04/2019
91	Mr. Ram Ksishna Pandey	Hindi	Prof. Meera Dixit	08/04/2019
92	Mr. Sone Lal	Hindi	Prof. Chanda Devi	08/04/2019

UNIVERSITY OF ALLAHABAD

Sl.No.	Name of Candidate	Department	Name of Supervisor	Date of R.D.C.
93	Ms. Ananya Singh	Education	Prof. Dhananjay Yadav	08/04/2019
94	Ms. Bhawana Shukla	Sanskrit	Prof. Suchitra Mitra	08/04/2019
95	Ms. Neelam Dwivedi	Political Science	Prof. M.P. Dubey	08/04/2019
96	Ms. Neeti Singh	Philosophy	Prof. Devashish Guha	08/04/2019
97	Ms. Supriya Singh	Music	Dr. Rashmi Dixit	08/04/2019
98	Mr. Bechan Yadav	Geography	Prof. S.S Ojha	01/05/2019
99	Mr. Harikesh Kr. Tripathi	Sanskrit	Prof. Ram Sewak Dubey	07/05/2019
100	Mr. Abhishek Agnihotri	Sanskrit	Prof. Ram Sewak Dubey	09/05/2019
101	Mr. Abhishek Kumar	Philosophy	Prof. Rishi Kant Pandey	09/05/2019
102	Mr. Ajay Kumar Yadav	English	Prof. Gunjan Sushil	09/05/2019
103	Mr. Anubhav Varshney	Philosophy	Dr. Asha Lal	09/05/2019
104	Mr. Ganesh Singh	Philosophy	Prof. Jata Shankar	09/05/2019
105	Mr. Gautam Mishra	Philosophy	Dr. Asha Lal	09/05/2019
106	Mr. Prashant Singh	Hindi	Prof. Lalsa Yadav	09/05/2019
107	Mr. Yuvraj Singh	Philosophy	Prof. Gopal Sahu	09/05/2019
108	Ms. Amita Yadav	Hindi	Dr. K.S Pandey	09/05/2019
109	Ms. Annu Singh	Philosophy	Prof. Debashish Gupta	09/05/2019
110	Ms. Jyoti Keshri	Philosophy	Prof. Gopal Sahu	09/05/2019
111	Ms. Mala Devi	Sanskrit	Prof. Ram Sewak Dubey	09/05/2019
112	Ms. Malvika Tripathi	Music	Dr. Vidyadhar Prasad Mishra	09/05/2019
113	Ms. Pratibha Singh	Philosophy	Dr. Asha Lal	09/05/2019
114	Ms. Rekha Jaiswal	English	Prof. Sumita Parmar	09/05/2019
115	Ms. Roohi Rawat	Geography	Prof. A.R. Siddiqui	09/05/2019
116	Ms. Suman Yadav	Hindi	Prof. Meera Dixit	09/05/2019
117	Mr. Desh Deepak Singh	Geography	Prof. A.R Siddiqui	15/05/2019
118	Mr. Mritunjay Rao	English	Prof. R.K. Singh	15/05/2019
119	Mr. Anurag Tripathi	Sanskrit	Prof. R.S Dubey	16/05/2019
120	Mr. G. Ganeshan Mishra	Hindi	Prof. Meera Dixit	16/05/2019
121	Mr. Parvej Alam	Geography	Prof. A.R. Siddiqui	16/05/2019
122	Mr. Shailendra Kr. Yadav	Ancient History	Prof. D.K Shukla	16/05/2019
123	Mr. Vipul Kumar	Psychology	Prof. Neena Kohli	16/05/2019
124	Ms. Aliya Rifat	English	Prof. Raju Pargi	16/05/2019
125	Ms. Farah Shoaib	Psychology	Prof. Neena Kohli	16/05/2019
126	Ms. Shreshtha Yadav	Psychology	Prof. Neena Kohli	16/05/2019
127	Mr. Abhishek Singh	Ancient History	Prof. J.N. Pal	10/06/2019
128	Mr. Anoop Kumar	Med./Mod. History	Prof. Yogeshwar Tiwari	10/06/2019
129	Mr. Dharmendra Pratap Shukla	Hindi	Prof. Kripa Shankar Pandey	10/06/2019
130	Mr. Jitendra Kumar	Ancient History	Prof. H.N Dubey	10/06/2019
131	Mr. Om Prakash Ratnakar	English	Prof. Gunjan Shushil	10/06/2019
132	Mr. Pradeep Kr. Yadav	Med./Mod. History	Prof. Alok Prasad	10/06/2019
133	Mr. Sant Raj	Ancient History	Prof. A.P. Ojha	10/06/2019
134	Mr. Shyam Babu	Hindi	Prof. Chanda Devi	10/06/2019
135	Ms. Ananya Singh	Education	Prof. Dhananjay Yadav	10/06/2019
136	Ms. Ankita Malviya	Sanskrit	Prof. Ram Sewak Dubey	10/06/2019
137	Ms. Archana Mishra	Psychology	Prof. Deepa Punetha	10/06/2019
138	Ms. Anushree Srivastava	Chemistry	Dr. I.R Siddiqui	04/07/2018
139	Mr. Jadveer Singh	Chemistry	Prof. Vandana Singh	09/07/2018
140	Mr. Yasharth Gautam	Defence Studies	Prof. M.N Verma	09/07/2018
141	Ms. Somlata Gautam	Botany	Prof. Nupur Bhowmik	09/07/2018

UNIVERSITY OF ALLAHABAD

Sl.No.	Name of Candidate	Department	Name of Supervisor	Date of R.D.C.
142	Ms. Ritu Swamini Bala	Chemistry	Prof. A.K Singh	06/08/2018
143	Mr. Arvind Kumar Pandey	Chemistry	Prof. Vandana Singh	08/08/2018
144	Mr. Ashutosh Kr. Singh	Electronics & Communication	Prof. N.K Shukla	08/08/2018
145	Mr. Manoj Kumar Singh	Zoology	Dr. K.P Singh	08/08/2018
146	Mr. Om Prakash	Electronics & Communication	Prof. Nar Singh	08/08/2018
147	Mr. Sandeep Kumar	Statistics	Prof. Anoop Chaturvedi	08/08/2018
148	Mr. Saransh Wales Maurya	Chemistry	Prof. I.R Siddiqui	08/08/2018
149	Ms. Aishwarya Singh Chauhan	Biochemistry	Prof. Bechan Sharma	08/08/2018
150	Ms. Pratyasha Tripathi	Statistics	Prof. S. Lalita	08/08/2018
151	Ms. Rupam Yadav	Chemistry	Prof. A.K Singh	08/08/2018
152	Mr. Vivek Kumar Pandey	Mathematics	Prof. P.N Pandey	28/08/2018
153	Mr. Ajay Kumar	Botany	Prof. Manju Sahney	06/09/2018
154	Mr. Brijesh Kumar Shukla	Chemistry	Prof. Vijay Krishna	14/09/2018
155	Ms. Ammatul Fatima	Home Science	Prof. Sangita Srivastava	14/09/2018
156	Ms. Bhoomika Awasthi	Electronics & Communication	Prof. N.K Shukla	14/09/2018
157	Ms. Ranju Pradhan	Chemistry	Prof. A.K Singh	14/09/2018
158	Mr. Awadhesh Kumar	Electronics & Communication	Dr. Rajiv Ranjan Tiwari	23/10/2018
159	Mr. Toyaj Shukla	Chemistry	Prof. Shekhar Srivastava	23/10/2018
160	Mr. Rajesh Mishra	Electronics & Communication	Prof. C.K Dwivedi	04/12/2018
161	Mr. Rajesh Verma	Chemistry	Prof. Ramendra Kumar Singh	04/12/2018
162	Ms. Puneet Kumar Gupta	Statistics	Dr. P.S Pundeer	04/12/2018
163	Ms. Tanuja Srivastava	Statistics	Prof. S. Lalita	04/12/2018
164	Ms. Twinkle Keshari	Chemistry	Prof. L.D.S Yadav	04/12/2018
165	Ms. Ritika Srivastava	Chemistry	Prof. Ramendra Kumar Singh	20/12/2018
166	Ms. Sonal Srivastava	Botany	Prof. S.C Agrawal	23/12/2018
167	Mr Awadhesh Kumar Singh	Electronics & Communication	Prof. Nar Singh	23/01/2019
168	Mr. Anuj Kumar Singh	Statistics	Prof. Anoop Chaturvedi	23/01/2019
169	Mr. Ashutosh Kumar Dubey	Statistics	Prof. Anoop Chaturvedi	23/01/2019
170	Mr. Imtiyaz Husain	Botany	Prof. N.B Singh	23/01/2019
171	Ms. Neetu Sharma	Chemistry	Prof. A.k Srivastava	23/01/2019
172	Ms. Pragya Srivastava	Botany	Prof. H.K Kehri	23/01/2019
173	Ms. Sweta Singh	Electronics & Communication	Prof. C.K Dwivedi	23/01/2019
174	Ms. Geetika Garg	Biochemistry	Prof. Syed Ibrahim Rizvi	20/02/2019
175	Mr. Saiyed Salim Sayeed	Electronics & Communication	Prof. J.A Ansari	28/02/2019
176	Ms. Ayushi Tiwari	Chemistry	Dr. Geeta Watal	28/02/2019
177	Ms. Jyoti Malviya	Chemistry	Prof. R.K.P Singh	28/02/2019
178	Ms. Parul Parihar	Botany	Prof. Sheo Mohan Prashad	28/02/2019
179	Ms. Poonam Pathak	Chemistry	Prof. Jagdamba Singh	28/02/2019
180	Ms. Prachi Dubey	Chemistry	Prof. Geeta Watal	28/02/2019
181	Ms. Rachana Singh	Botany	Prof. Shiv Mohan Prashad	28/02/2019
182	Ms. Ranjana	Chemistry	Prof. A.k Srivastava	28/02/2019
183	Ms. Snehlata Yadav	Chemistry	Prof. Jagdamba Singh	28/02/2019
184	Mr. Girdhari Lal Chaurasia	Chemistry	Prof. P.K. Tandon	08/04/2019
185	Ms. Aditi Tiwari	Botany	Prof. D.N. Shukla	08/04/2019
186	Ms. Alka Srivastava	Chemistry	Prof. Krishna Srivastava	08/04/2019
187	Ms. Shalini Verma	Chemistry	Prof. Vijay Krishna	08/04/2019

UNIVERSITY OF ALLAHABAD

Sl.No.	Name of Candidate	Department	Name of Supervisor	Date of R.D.C.
188	Ms. Shashi Kala Devi	Chemistry	Prof. R.K.P. Singh	08/04/2019
189	Mr. Arvind Kumar Kushwaha	Defence studies	Dr. R.K Tandon	09/04/2019
190	Mr. Aashit Kumar Jaiswal	Physics	Prof. Raja Ram Yadav	09/05/2019
191	Mr. Akhilesh Kumar	Chemistry	Prof. Jagdamba Singh	09/05/2019
192	Mr. Alok Kumar Singh	Statistics	Prof. S. Lalitha	09/05/2019
193	Mr. Dilip Kumar Maurya	Defence Studies	Prof. Shekhar Adhikari	09/05/2019
194	Mr. Kamal Kishor Upadhyay	Electronics & Communication	Prof. N.K Shukla	09/05/2019
195	Mr. Rajeev Lohiya	Chemistry	Prof. Shekhar Srivastava	09/05/2019
196	Mr. Shubham Bajpai	Botany	Prof. D.N Shukla	09/05/2019
197	Ms. Akanksha Srivastava	Botany	Prof. G. Kumar	09/05/2019
198	Ms. Hozeyfa Sagir	Chemistry	Prof. I.R Siddiqui	09/05/2019
199	Ms. Shiva Sharma	Physics	Dr. Pratima	16/05/2019
200	Ms. Archana Mishra	Psychology	Prof. Deepa Punetha	10/06/2019
201	Ms. Sneh Lata Rahi	Botany	Prof. Manju Sahney	10/06/2019
202	Ms. Anupama	Economics	Prof. G.C Tripathi	09/07/2018
203	Ms. Nidhi Ganguli	Economics	Prof. Jagdish Narayan	09/07/2018
204	Ms. Subhangi	Commerce	Prof. Anjani Kumar Malviya	09/07/2018
205	Mr. Rohit Kumar Tiwari	Economics	Prof. S.K Chaturvedi	08/08/2018
206	Mr. Vikash Kumar Shukla	Economics	Prof. Prahlad Kumar	14/09/2018
207	Mr. Yogendra Verma	Economics	Prof. P.K Ghosh	14/09/2018
208	Ms. Darshana Kumari	Economics	Prof. P.K Ghosh	14/09/2018
209	Mr. Krishan Mani Tripathi	Economics	Prof. G.C Tripathi	23/10/2018
210	Ms. Shivi Srivastava	Commerce	Prof. A.K Singhal	23/10/2018
211	Mr. Shubham Kaushik	Commerce	Prof. Anjani Malviya	04/12/2018
212	Mr. Avinash Kumar Singh Yadav	Economics	Prof. P.K Ghosh	23/01/2019
213	Mr. Mohd. Faizi	Commerce	Prof. J.N Bhargava	23/01/2019
214	Ms. Bharti Singh	Economics	Prof. M.M Krishna	23/01/2019
215	Ms. Vandana	Economics	Prof. Shri Javed Akhtar	23/01/2019
216	Mr. Anit Dubey	Commerce	Prof. A.K Singhal	28/02/2019
217	Mr. Azimur Rajman	Commerce	Prof. A.K Malviya	28/02/2019
218	Mr. Sarvesh Singh	Commerce	Prof. R.S Singh	28/02/2019
219	Mr. Rishi Raj Sarkar	Commerce	Prof. Ramendu Roy	08/04/2019
220	Ms. Arpita Chaturvedi	Commerce	Prof. R.S. Singh	08/04/2019
221	Ms. Renu Srivastava	G.B. Pant Institute	Prof. S.K Pant	08/04/2019
222	Ms. Priyanka Singh	Centre of Food Technology	Dr. Pinki Saini	08/04/2019
223	Ms. Abhi Sarika Bharti	Center of Environmental Science	Prof. K.N Uttam	09/05/2019
224	Mr. Namendra Kr. Shahi	K.B.C.A.O.S.	Dr. Shailendra Rai	16/05/2019
225	Mr. Brijesh Kumar	Rajeev Gandhi Chair	Prof. Pranay Krishan Srivastava	16/05/2019